

# Computational Modeling of Esophageal Stricture

A Final Report Submitted to the

Department of Biomedical Engineering  
School of Engineering and Applied Science  
University of Virginia, Charlottesville, VA

Inusah Diallo, Georgia Mackenzie, Anant Tewari  
Group 6

Number of Words: 2285

Number of Figures and Tables: 6

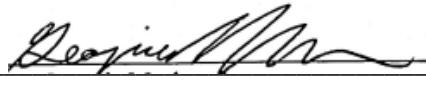
Number of Equations: 0

Number of Supplements: 4

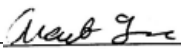
Number of References: 17

Signatures  \_\_\_\_\_  
Inusah Diallo

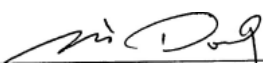
Date: 04/29/20

Signatures  \_\_\_\_\_  
Georgia Mackenzie

Date: 04/29/20

Signatures  \_\_\_\_\_  
Anant Tewari

Date: 04/29/20

Approved  \_\_\_\_\_  
Dr. Haibo Dong

Date 04/29/20

# Computational Modeling of Esophageal Stricture

Anant Tewari<sup>a</sup>, Georgie Mackenzie<sup>b</sup>, Inusah Diallo<sup>c,1</sup>

<sup>a</sup> Anant Tewari

<sup>b</sup> Georgie Mackenzie

<sup>c</sup> Inusah Diallo

<sup>1</sup> Correspondence: art5cb@virginia.edu

## Abstract

Esophageal atresia is a congenital birth defect resulting in abnormal anatomy of the trachea and esophagus. While there is an effective method for rejoining the proximal and distal ends of the esophagus, patients often face complications with stricture at the site of anastomosis. The aim of this study was to learn more about the pathophysiology of both esophageal atresia and post-operative esophageal stricture-formation through computational modeling. In order to fully understand this clinical problem, pathophysiological impacts of this complication were supplemented with patient charts. IRB Approval (UVA IRB #21990) was deemed unnecessary to access deidentified patient imaging. This allowed for the use of pediatric apical chest x-rays as a means to use CAD to create 3D esophageal models. A novel method for creating 3D esophageal models was explored, and the resultant models were subject to computational fluid dynamics (CFD) with the use of ANSYS Fluent. Through the UVA Health System, imaging of 4 patients (n = 4) were used. The CFD results show an increase in wall shear stress at the site of stricture when compared to the normal esophageal diameter. The results also showed an increase in static pressure proximal to the point of stricture. Due to the results, the team made several recommendations to the current designs for mesh stents, which is a therapeutic intervention currently used to reinforce the esophagus. The first finding is that stents should be double the length proximal to the point of stricture than distal to it, to mitigate the physiological results of increased static pressure. Secondly, there should be further research into a material development that minimizes abrasions at the interface of the esophagus tissue and the stent, and research into the development of a non-woven design. These novel findings provide future avenues to increase the efficacy of current methods used to treat esophageal stricture.

Keywords: Esophageal Stricture, Computational Fluid Dynamics, Mesh Stent Design

## Introduction

Esophageal atresia is a birth defect that impacts about 2.8 individuals per 10,000 births in the United States. The condition occurs when the esophagus develops into two discontinuous portions instead of a single passage-way<sup>1</sup>. This can result in complications such as the inability to eat food or drink fluids. C-type atresia is the most common form and occurs when the upper portion of the esophagus forms a pouch and the lower section attaches to the trachea, shown in figure 1. In the patients that we examined, stricture diameter was found to range between 32-60% smaller than the diameter of the healthy, esophagus. The current treatment method is a corrective surgery that connects the two portions of the esophagus<sup>2</sup>. In about 20-50% of patients who receive surgical treatment for atresia, a narrowing of the esophagus, called an anastomotic stricture, can occur post-operation. The large deviation in repeated esophageal stricture results from variations in the etiology, corrective surgery, and patient-specific immune system factors<sup>3</sup>, but highlights the frequency of individuals requiring post-surgery adjustments<sup>4</sup>. Currently, there is no definitive cause for the anastomotic strictures and the current treatments are not permanent solutions.

The larger objective of this study was to determine solutions to reduce the frequency of hospitalization readmission for patients experiencing esophageal stricture post corrective-surgery. Readmission typically consists of dilation treatments to expand the stricture site and have recently incorporated additional physiological and mechanical methods discussed in the innovation section. Determining how to optimize esophageal stents will limit the recurrent visits to hospitals and drastically

improve the standard of living for patients experiencing esophageal strictures. It would also be helpful to gain a further understanding of the pathophysiology of myofibroblast buildup and deposition of scar tissues. The current market defines overall generic solutions applied to all patients, which have significant complications and consequences after administration, including retrosternal pain, bleeding, and recurrent inflammation<sup>6</sup>. One major consequence of esophageal stent placement is their propensity to migrate into the stomach, and even cause severe abdominal obstructions. Stent migration occurs in 30-55% of cases, and is associated with less chance of clinical success<sup>7</sup>. In fact, it can cost families of patients upwards of \$1487.98 to cover the costs of stent migration (in case of a clinician predicting a 40% chance of stent migration)<sup>8</sup>. Mechanical modeling through a computational approach were used to highlight areas of high stress in the esophagus and flow parameters that are specific to the images of each patient. This will provide a clear understanding of what is happening to esophageal tissue and the cellular activities in specific patients, allowing for clear and unique solutions to improve readmission rates.

A novel solution for anastomotic strictures would contribute significantly to scientific fields. Stricture is a common complication arising in smooth muscle tissues, including the colon and urethra. Current research seems to indicate that strictures are a result of scar tissue build-up in the esophagus after corrective surgery for atresia<sup>9</sup>. If a treatment is created then similar conditions caused by scar tissue build up can be improved upon, including post-heart attack cardiac dysfunction, colon stricture, and urethral strictures. Additionally, a new permanent solution would significantly benefit public health as a permanent solution would reduce

the amount of time and frequency a patient would have to stay in the hospital. Furthermore, most patients with anastomotic strictures are children. Current literature highlights that there is a lack of research into esophageal stent development for the pediatric population suffering from recurrent stricture<sup>10</sup>. Research has shown that frequent hospital stays and visits can be detrimental to the cognitive development of children<sup>11</sup>. As discussed with Dr. Eliza Holland, patients that have jejunostomy tube (J tubes) or nasogastric (NG) tubes placed for long periods of time can lead to the development of oral aversion. As such, reducing the amount of time these children spend in the hospital for recurrent stricture treatment would help reduce any disruption to their early development.

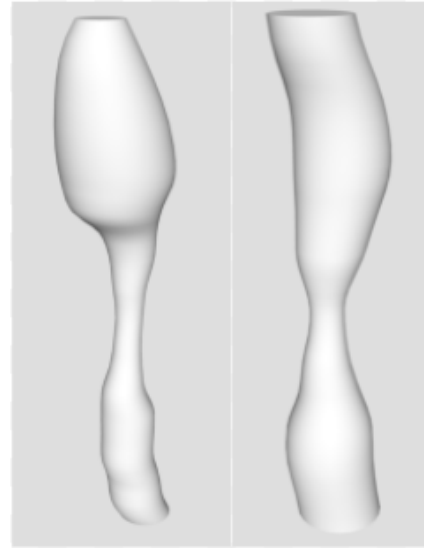
Here, the team focuses on developing novel improvements to esophageal stents that are currently in use, such as the Alimaxx Esophageal Stent manufactured by Merit<sup>12</sup>. We proposed a method for measuring forces in the esophagus through first creating 3D models, then completing CFD simulations on the esophageal models with the use of ANSYS Fluent. The viscosity of common food options for young children was researched and imported into the ANSYS Fluent software, along with a common density. To model the solid and fluid movement throughout the esophagus, a k-omega two equation turbulence model was used, which is used as a closure for the Reynolds-averaged Navier–Stokes equations. The two transport equations represent the turbulent properties of the flow, with k representing the turbulent kinetic energy and omega parameter quantifying the specific dissipation<sup>13</sup>. Additionally, the fluid movement was provided an initial velocity based on normal functioning movement through the esophagus, as the primary forces build-up at the anastomosis site, and initial velocity should therefore be unaffected. We sought to collect data (measured in Pascals) on the values for static pressure, dynamic pressure, wall shear stress, and coefficient of skin friction throughout strictured esophageal profiles. Static pressure and dynamic pressure were analyzed to determine the differences in forces depending on fluid movement. Shear stress is vital in understanding how the esophagus may experience stress perpendicular to fluid movement, coplanar to the material cross section. Skin Friction Coefficient is a dimensionless skin shear stress normalized by the dynamic pressure of a free fluid stream. These parameters have correlation to sites of increased inflammation in body structures. Analyzing esophageal profiles through CFD simulations revealed that static pressure is greatest above the point of stricture, dynamic remains unchanged, and that wall shear stress and the coefficient of skin friction are both greatest at the point of stricture.

## Results

Shown in table S1 are patient history, complications, and diagnosis regarding their esophageal atresia and stricture pathology and treatment. This information is vital to better understand why a patient requires frequent hospitalizations and what the current process is for long-term recovery. Apical chest x-rays of four patients were then used as the basis for 3D models (see S1 and S2). Isolation of esophagi from the x-ray images provides the base for input into the computational modeling process. The extractions were used to create preliminary models in Autodesk of 3D esophagi. The physical models of esophageal stricture are created in Autodesk, shown in figure 1, and exported as .igs files (Initial Graphics Exchange Specification), used for optimal geometry configuration in Ansys Fluent, the Computational Fluid Dynamics (CFD) software used in this study.

### Contour Plots of Desired Parameters

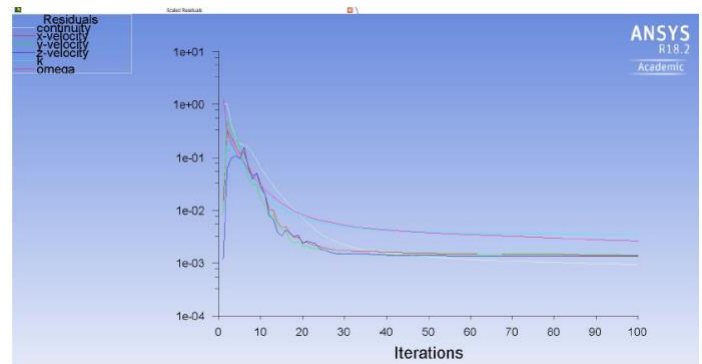
Analysis of the geometries produced in Autodesk, was conducted using Ansys Fluent. Shown in figure 2 is a plot of the residuals over iterations for the computational modeling calculation for patient 1.



**Fig. 1. Physical Models.** Shown are the physical models produced in Autodesk, created from x-ray images of patients with esophageal stricture

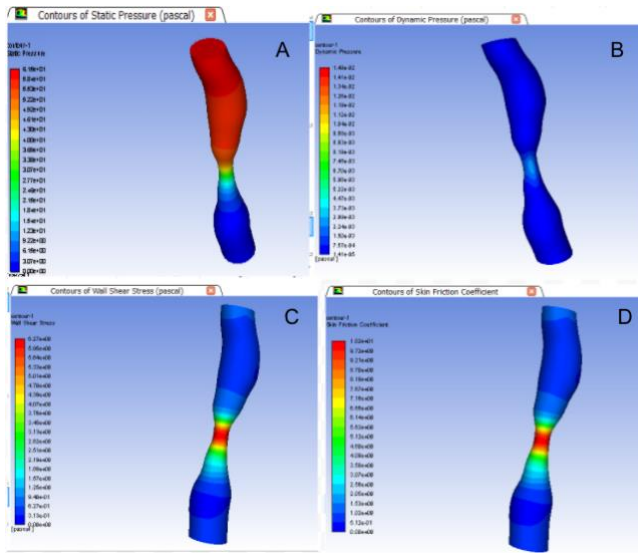
The residuals highlight the inherent error within the model, and as the residuals plateau to a constant value, that demonstrates stability within the model. The decay to the steady state values indicates that the CFD analysis produces a stable model.

Shown in figure S2 are six contours plots of specific example parameters that could be utilized for our analysis. These plots were not directly used for our future stent recommendations but instead utilized to gain further understanding of the modeling process and software.

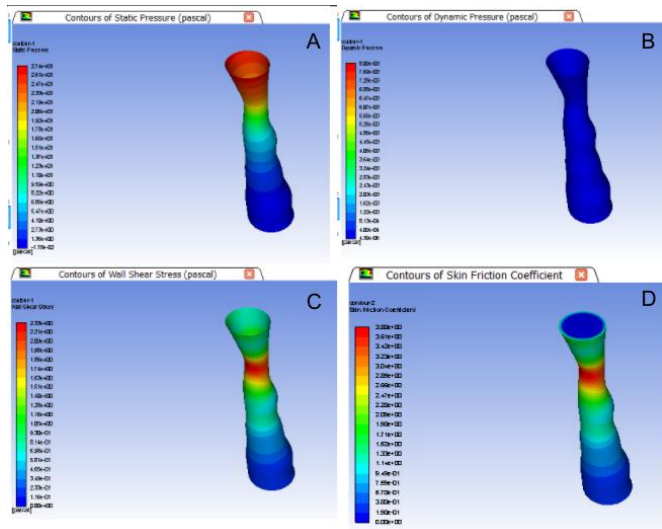


**Figure 2. Plot of Residuals over Iterations.** Residuals indicate the inherent error within the model. As the number of iterations increases, the residual value should reach a steady state, indicating stability in the model. Shown above is the output of the residuals over time for the first esophageal model. The stabilization over the number of iterations illustrates the stability within the model.

Shown in figures 3, 4, and 5 are the results from CFD analysis of three patients with esophageal stricture. No change in dynamic pressure was observed throughout any of the esophageal stricture profiles, but changes in static pressure, shear stress, and skin friction coefficient were all observed. Specifically, static pressure was found to be greatest above areas of stricture, and at a minimum below areas of stricture. The shear stress and skin friction coefficient experienced by the esophageal wall was greatest at areas of the smallest esophageal diameter.

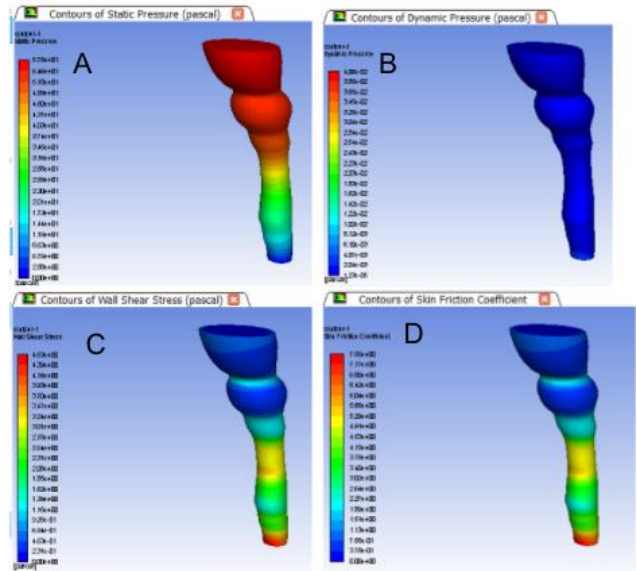


**Figure 3. Modeling Results from CFD analysis of Patient 2. A)** Contour of Static Pressure **B)** Contour of Dynamic Pressure **C)** Contours of Wall Shear Stress. **D)** Contour of Skin Friction Coefficient



**Figure 4. Modeling Results from CFD analysis of Patient 3. A)** Contour of Static Pressure **B)** Contour of Dynamic Pressure **C)** Contours of Wall Shear Stress. **D)** Contour of Skin Friction Coefficient

The contours plots shown above are the outputs from CFD simulation and analysis of the four strictured esophageal profiles. The important parameters for the understanding of esophageal stricture are static pressure, dynamic pressure, wall shear stress, and skin friction coefficient. These parameters are useful in determining the points of greatest inflammation within the esophagus to determine which areas require the greatest attention in long term treatment. Previous studies have found the location of highest pressure in computational modeling to also be the location of greatest inflammation.



**Figure 5. Modeling Results from CFD analysis of Patient 4. A)** Contour of Static Pressure **B)** Contour of Dynamic Pressure **C)** Contours of Wall Shear Stress. **D)** Contour of Skin Friction Coefficient

Table 1 details two key flow parameters that are linked with increased inflammation. Measurements for both wall shear stress and skin friction coefficient were taken at the inlet of the esophagus and at the point of greatest narrowing or stricture of the esophagus in order to illustrate how stricture can impact these two parameters. We observed an increase in shear stress and skin friction coefficient at the greatest point of stricture, highlighting the increased torque and forces coplanar to the esophageal cross-section present at that site.

Patient	Change in Shear Stress (Pascals)	Change in Skin Friction Coefficient
Patient 2	5.013	8.012
Patient 3	1.400	2.800
Patient 4	0.710	1.135

**Table 1. Change in Shear Stress and Skin Friction Coefficient.** Shown are the respective changes of shear stress and skin friction coefficient for each patient from the esophageal inlet to point of greatest stricture.

**Discussion**

To allow for normal feeding and speech, clinical intervention is necessary for pediatric patients experiencing esophageal stricture post-corrective surgery. While esophageal stents exist to increase stricture diameter, there is clear evidence that stents do not provide long term, permanent solutions for patients suffering from esophageal stricture. Additionally, the risk of migration resulting in the removal of stents presents patients with monetary burden as well as continuing stricture complications. In order to properly understand how to optimize stent designs, the esophagus itself needs to be evaluated. CFD simulations aided in determining the areas of greatest weakness of the strictured esophagus, and subsequently helped identify possible points of improvement for stent designs. The results clearly illustrate that the magnitude of force along the esophageal profile is not uniform, and therefore requires a therapeutic intervention that is not uniform in its application of pressure onto the esophagus. While current stents are mostly composed of, woven

into a mesh design, and uniform in diameter (apart from a flared proximal and distal ends), it is clear that these technological advances do not successfully treat esophageal strictures<sup>14</sup>. From the results gathered, it's clear that the forces present in the esophagus when passing fluids are nonuniform.

Current stents are designed to be self-expandable to provide enough radial force to withstand closure of the esophagus<sup>15</sup>. Stents are usually composed of either metal (either stainless steel or nitinol), plastic, or made of a biodegradable material, through weaving together poly-l-lactic-monofilaments<sup>16</sup>. Due to the mesh design of these stents it is common for tissue to grow through the stent at the site of abrasions, stricture, or in the case of esophageal cancer, at the tumor site. It is also clear that because of the high values of wall shear stress and coefficient of skin friction at the stricture site, it is paramount that stents do not lacerate the tissue. The suggestions for modifications are: non-mesh design at the point of stricture, increased length of stent, plus mitigation of static pressure above stricture-point. These three improvements are aimed at decreasing the prevalence of stent-related bleeding, muscular distortion, and migration past the upper or lower esophageal sphincter. A non-mesh portion of the stent at the point of stricture could be composed of a biocompatible plastic such as thermoplastic polyurethane (TPU). This plastic has been tested successfully in harvested porcine esophagi, and has been shown to withstand inward radial force with success<sup>17</sup>. Due to its smooth surface, this material will have minimal negative impacts on esophageal tissue. Only the portion of the stent at the stricture site should be composed of TPU, as it's speculated that a complete TPU-based stent could easily migrate. Because of this, the TPU could encase only the center of the stent, while the proximal and distal ends remain as either stainless steel or nitinol. Another suggestion includes the concept of increasing the length of the stent proximal to the stricture site. One method to counteract the increased static pressure proximal to the site of stricture is to suture the mesh portion of the stent in place. While this may help mitigate the increase in diameter (from outward pressure) above the stricture site, it will also help to decrease the chance of migration<sup>7,8</sup>. These modifications have been illustrated in figure S3.

The modifications suggested for current stents comes not from educated guesswork, but instead from a detailed analysis of how the esophageal profile can best be supported. The efficacy of these improvements can be tested through first implementing the modifications through CAD, and then subjecting the optimized models to finite element analyses. While some of the recommendations are simple, to fully implement these improvements, there is a need to reevaluate the materials currently used to construct stents. Further research must be conducted to identify a material impervious to erosion, fracture, and malleability over time. Pursuit of these design goals will lead to a lower incidence of stent failure in cases of esophageal stricture, and will improve patient outcomes.

Several obstacles limited the overall scope of this project. One of these hurdles was obtaining IRB approval which was required to obtain patient X-ray images. The process necessitated a variety of steps that delayed obtaining the X-ray images. We had started to begin researching the process in October and submitted our request in November. Additionally our team had hoped we could have used CT images in order to help build our computational model, but we soon discovered that CT images are extremely rare in case of imaging esophageal stricture. Lastly due to the impact of the COVID-19 pandemic we were unable to obtain more images. As such the results derived from this study are based on a relatively small sample size.

## Materials and Methods

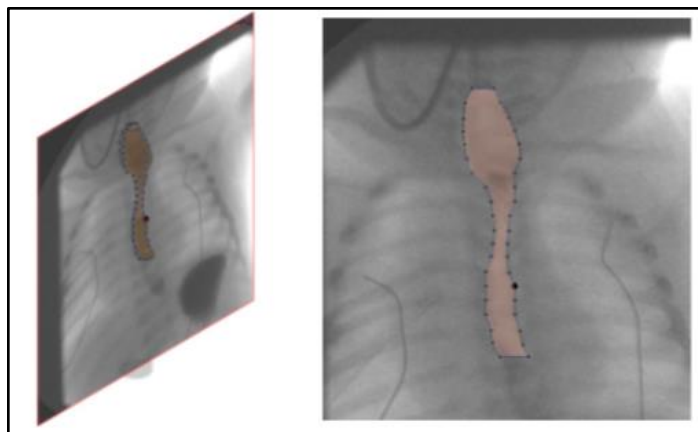
After discussion of the project specifications with representatives of the University of Virginia's IRB, it was deemed that IRB approval was not necessary to obtain deidentified patient imaging. All identifiable aspects of patient charts collected by Dr. Eliza Holland and patient films collected by Dr. Reza Daugherty were removed before distribution. This includes the birthdates, names, and MRNs of patients. The apical and lateral chest x-rays of four pediatric patients with esophageal stricture were provided to the team.

The diagnostic x-rays were used as the basis for 3D models. Images were imported into Autodesk Fusion 360, and final models were exported as .IGES files for use in CFD simulations. The percent stricture with respect to normal esophageal diameter was measured and calculated with the use of ImageJ. In Autodesk Fusion 360, the esophageal profile was first outlined, then circles, orthogonal to the image and offset at .5 mm increments were placed with a diameter correlating to the esophageal diameter. Each circle was lofted together to create a 3D model from the 2D images.

With the help of graduate students Junshi Wang and Zhipeng Lou from Dr. Haibo Dong's Fluid Simulation Research Group, the team learned how to apply simulations to imported passageways. In this case, the passageway is the esophagus. After initial instruction, the team used ANSYS Fluent to measure the parameters of static pressure, dynamic pressure, wall shear stress, and coefficient of skin friction through CFD analysis. ANSYS Fluent utilizes a multi-step process, beginning with importing the geometry in Ansys Fluent as a graphics file in a 2D/3D vector format based on the Initial Graphics Exchange Specification, specifically .igs format. With the geometry, a mesh is created along the wall, inlet, and outlet of the esophageal profile specifically with sizing limits of 1 mm. Building the mesh allows for setup of CFD calculation. A k-omega model was used to detail the fluid movement throughout the esophagus, beginning with an initial velocity of .02 m/sec. The viscosity and density were adjusted to approach normal ranges for common food intake for a young child with esophageal stricture. Specifically, the viscosity inputted was 2.0 cP and density was 1.75 kg/m<sup>3</sup>. A standard initialization was utilized under the ANSYS Fluent software, and the calculation was run with a time step size of .0004 sec to a total of 5000 time steps. Contour plots were obtained of the parameters of interest, specifically static pressure, dynamic pressure, wall shear stress, and skin friction coefficient.

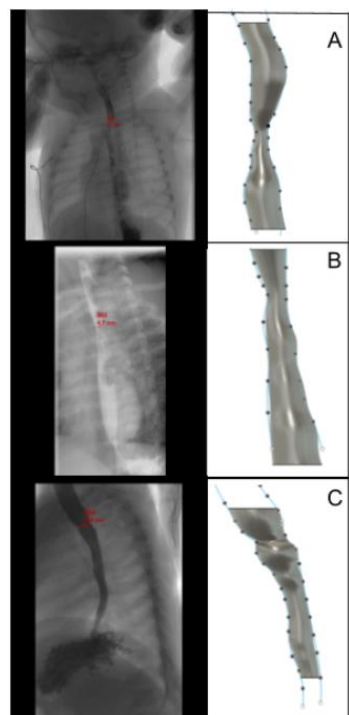
**Supplementary Figures**

Patient 1	Patient 2
<p>Born with Type A t-fistula, long gap esophageal atresia. Underwent a gastric pull-up procedure. Experienced complications regarding a tracheal abnormality with noisy breathing and tracheal collapse during breathing. Also faced Bronchomalacia, in which the stomach is pressed up against the lungs.</p> <p>Current Feeding: Jejunostomy (J) tube, continuous drip feeds.</p> <p>Current Complications: Difficulties with Secretions, pool at the bottom of esophageal pouch. Serious implications for current respiratory issues.</p>	<p>Born with Esophageal atresia and also severe hydrocephalus. Thoracotomy for esophageal anastomosis revision (9/15/19), will begin esophageal dilations ~ 12/4/19.</p> <p>Current Feeding: Post-pyloric gastrostomy(g) tube with TPN (Total Parenteral Nutrition), Trophic, Continuous Feeds (few drops at a time)</p> <p>Will use Nasogastric Tube (NG) to dilate esophagus.</p> <p>Botox injections were also administered to relax the esophageal sphincter and provide relief for patients with achalasia.</p>

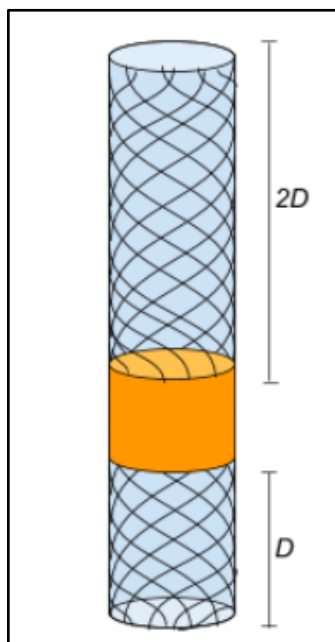


**Supplementary Figure 2. Esophagus model of patient 1 overlaid onto chest x-ray.**

**Supplementary Table 1. Information from two patients born with Esophageal atresia.** Details include initial diagnosis, complications, and feeding method.



**Supplementary Figure 1. Obtaining esophageal models.** Left, apical chest x-rays of pediatric patients 2-4 with esophageal stricture. To the right of each x-ray are the corresponding models A-C, generated in Autodesk Fusion 360. Patient 1's esophageal model is not pictured, and was used to test the feasibility of using ANSYS Fluent to run simulations.



**Supplementary Figure 3. Mesh Stent Implications.** Improvements to current mesh stent, with a TPU ring at the stricture site (pictured in orange), and a proximal length double that of the distal end, to allow for suturing to esophageal wall at points of greatest static pressure.

## End Matter

### Acknowledgments

Many thanks to Dr. Eliza Holland, Dr. Reza Daugherty, Dr. Mike Shorofsky, Dr. Haibo Dong, and graduate students Junshi Wang and Zhipeng Lou for all of your help this year.

### References

1. Kuo, B. & Urma, D. Esophagus - anatomy and development. *GI Motil. Online* (2006) doi:10.1038/gimo6.
2. Scott, D. A. Esophageal Atresia/Tracheoesophageal Fistula Overview. in *GeneReviews®* (eds. Adam, M. P. et al.) (University of Washington, Seattle, 1993).
3. Fan, Xiaowen. P1159 - Inpatients Requiring Dilation for Esophageal Strictures Have High Rates of Readmission Regardless of Etiology. (2018).
4. Raitio, A., Cresner, R., Smith, R., Jones, M. O. & Losty, P. D. Fluoroscopic balloon dilatation for anastomotic strictures in patients with esophageal atresia: A fifteen-year single centre UK experience. *J. Pediatr. Surg.* 51, 1426–1428 (2016).
5. Simsek, A., Aldamhori, R., Chapple, C. R. & MacNeil, S. Overcoming scarring in the urethra: Challenges for tissue engineering. *Asian J. Urol.* 5, 69–77 (2018).
6. Experience with fully covered self-expandable metal stents for anastomotic stricture following esophageal atresia repair. - PubMed - NCBI. <https://www.ncbi.nlm.nih.gov/pubmed/29939253>.
7. Wright, A. et al. Endoscopic suture fixation is associated with reduced migration of esophageal fully covered self-expandable metal stents (FCSEMS). *Surg. Endosc.* 31, 3489–3494 (2017).
8. Shah, E. D., Hosmer, A. E., Patel, A., Morales, S. & Law, R. Valuing innovative endoscopic techniques: endoscopic suturing to prevent stent migration for benign esophageal disease. *Gastrointest. Endosc.* 91, 278–285 (2020).
9. Surgical Mesh as a Scaffold for Tissue Regeneration in the Esophagus - Abstract - European Surgical Research 2004, Vol. 36, No. 2 - Karger Publishers. <https://www.karger.com/Article/Abstract/76650>.
10. Slater, B. J., Pimpalwar, A., Wesson, D., Olutoye, O. & Pimpalwar, S. Esophageal stents in children: Bridge to surgical repair. *Indian J. Radiol. Imaging* 28, 242–246 (2018).
11. Adams, R. J., Smith, B. J. & Ruffin, R. E. Factors associated with hospital admissions and repeat emergency department visits for adults with asthma. *Thorax* 55, 566–573 (2000).
12. Vermeulen, B. D. & Siersema, P. D. Esophageal Stenting in Clinical Practice: an Overview. *Curr. Treat. Options Gastroenterol.* 16, 260–273 (2018).
13. K-omega models -- CFD-Wiki, the free CFD reference. [https://www.cfd-online.com/Wiki/K-omega\\_models](https://www.cfd-online.com/Wiki/K-omega_models).
14. Volenec, K. & Pohl, I. The challenges: Stent materials from the perspective of the manufacturer. *Gastrointest. Interv.* 5, 98–104 (2016).
15. Kang, Y. A Review of Self-Expanding Esophageal Stents for the Palliation Therapy of Inoperable Esophageal Malignancies. *BioMed Research International* vol. 2019 e9265017 <https://www.hindawi.com/journals/bmri/2019/9265017/> (2019).
16. Repici, A., Hassan, C., Sharma, P., Conio, M. & Siersema, P. Systematic review: the role of self-expanding plastic stents for benign esophageal strictures. *Aliment. Pharmacol. Ther.* 31, 1268–1275 (2010).
17. Lin, M., Firoozi, N., Tsai, C.-T., Wallace, M. B. & Kang, Y. 3D-printed flexible polymer stents for potential applications in inoperable esophageal malignancies. *Acta Biomater.* 83, 119–129 (2019).