

**SENTINEL: A NOVEL DEVICE TO ALERT CYCLISTS OF VEHICLES  
APPROACHING FROM THE REAR**

A Research Paper submitted to the Department of Electrical and Computer Engineering  
In Partial Fulfillment of the Requirements for the Degree  
Bachelor of Science in Electrical Engineering

By

AJ Cuddeback

December 17, 2021

On my honor as a University student, I have neither given nor received unauthorized aid on this assignment as defined by the Honor Guidelines for Thesis-Related Assignments.

ADVISOR

Harry Powell, Department of Electrical and Computer Engineering

# The End of Our FUN

---

*Rex Serpe, AJ Cuddeback, Brandon Brnich, Julia Graham, Julia Rudy*

December 17<sup>th</sup>, 2021

**Capstone Design ECE 4440 / ECE4991**

## Signatures



---



---

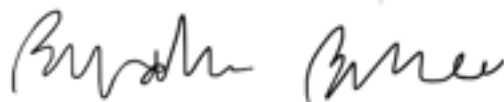

---



---



---

## **Statement of Work**

### **Brandon Brnich**

My primary role in this project was to design the firmware architecture of this system. This responsibility included extensive planning at the beginning of the semester in order to create an efficient workflow between myself and Julia Rudy. The planning for the system level design began by first assisting AJ in the selection of the radar sensor. My contribution to this selection derives from reading through the communication protocols of each prospective sensor in order to choose one that is not only powerful, but also provides intuitive and easily decoded information. Once the sensor was selected and the group knew the data that had to be processed, I was tasked with selecting the microcontroller that would be used in the design. Since our group is constrained with conserving as much power as possible due to relying heavily on solar charge, this selection process was quite methodical. After this selection was made, Julia Rudy and I were able to effectively split up the firmware tasks in order to complete the project.

Furthermore, I programmed a lot of the fundamental system code that was used in our project. Specifically, I wrote the drivers for the clock to be used at 8 MHz, timers for interrupt driven code, as well as configuring our system to read the JavaScript Object Notation (JSON) packets be sent from the radar sensor using the Universal Asynchronous Receiver-Transmitter (UART) protocol [1]. Once I verified that the byte data was properly being read into the microcontroller, I was tasked with placing the data into a buffer in the necessary format for Julia Rudy to properly parse the information for the display. Lastly, I wrote code to synchronize the data being read from the sensor and the data being processed by the JSON parser. This needed to be done in order to not waste processing time reading in data that wouldn't be used, as well as assuring we are reading in data that is relevant to the surroundings of the current situation, rather than reading information that no longer pertains to the user's surroundings.

### **AJ Cuddeback**

My primary role in this project was system-level design and product integration. System-level design included solving problems which didn't fall into any specific technical domain and interfacing with target users to engineer user experience. Product integration included communicating with each team member to determine how their parts interfaced with each other and troubleshooting interface issues as they arose.

Examples of system-level design include selecting our sensor and conducting end-user validation of our notification system. As the sensor provided the core functionality for this project, sensor selection required interfacing with Rex, Brandon, and Julia R. to determine sensor communication and power constraints and researching safety metrics to determine performance

constraints. Once the sensor was selected, I became the primary point of contact for sensor-related troubleshooting which included communicating with sensor manufacturers to obtain additional sensor datasheets and working with individual team members to debug sensor integration. To validate our notification system, I collaborated with Professor Reid Bailey from Systems Engineering to select and approach for test-driven development of our notification system. I collaborated with Julia R. to develop an example notification to distribute to target users for testing. After collaborating with cycling clubs at UVA to survey target users, I worked with Brandon and Julia R. to implement a notification system based on the survey results. I organized and conducted field testing of sensor performance to determine both the extent of information available to drive the notification system and points where the firmware needed to correct for sensor error.

## **Julia Graham**

My primary responsibility was mounting and waterproofing of the various parts of the project. This involved compiling information about potential mounting methods, purchasing screws and mounting materials, and taking inventory of various physical dimensions. The first step of the mounting process began by taking a detailed look at the constraints: the board print sizes, battery size, available tools, and timeline. I created the first revision of the front LED display 3D print using Solidworks. I also designed all five revisions of the back mount box which houses the MSP, Power Board, sensor, and battery pack. As someone who had never utilized Solidworks, a CAD based software, a significant portion of time was spent learning the intricacies of the program, including its vast capabilities, especially related to drill holes. I identified a bike rack that was mountable on standard bike sizes and could accommodate the weight of the solar panel. I also worked alongside Julia Rudy to select various materials, including the front mount kit and screws. I scheduled a time to work with a friend in the Architecture school to get the plexiglass piece cut into the correct sizes by a laser-cutter in the Architecture shop and created DWG files describing the necessary cuts. I assembled the bike rack and aided in the physical assembly of the wiring. Lastly, I assisted in the testing of waterproofing.

## **Julia Rudy**

I was primarily responsible for the code that controlled the intuitive LED display. I decoded the JSON data provided by the Radar Sensor via UART. I also wrote the LED driver code that initialized the hardware PWM that controlled the LEDs. I worked on dynamically changing the LEDs blinking frequency using the hardware PWM based on dynamic range data given by the sensor. As my secondary responsibility, I help with the product mounting. I was responsible for the front 3D printed box that housed the LEDs mounted on the handlebars. This

included getting all accessories that allowed the front box to be waterproofed and stably mounted (jacketed wires, handlebar mount, waterproof wire connectors). I also provided help by doing field testing with the sensor, testing range capabilities.

## **Rex Serpe**

I was primarily responsible for developing the power PCB. I developed circuit schematics for a solar MPPT battery charger, a high efficiency switching converter to create a 5V power rail, and a linear regulator circuit to produce a 3.3V rail. This involved spending extensive time reading datasheets and becoming familiar with the various integrated circuits required to implement such a design. I also designed the physical layout of the board such that it could effectively interface with the radar sensor, MSP430 header board, battery, and solar panel through various connectors and interfaces. I converted these circuits into a manufacturable circuit board layout and carried out ordering and assembly. I then tested this board, carrying out a hardware testing process that culminated in a second revision of the circuit board. My secondary responsibility was to assist in the development of the LED display board, as well as wiring and integration of the complete system.

# Table of Contents

Signatures.....	1
Statement of Work .....	2
Brandon Brnich .....	2
AJ Cuddeback .....	2
Julia Graham .....	3
Julia Rudy.....	3
Rex Serpe .....	4
Table of Contents.....	5
Table of Figures .....	7
Table of Tables .....	8
Abstract.....	9
Background.....	9
Statement of Objectives .....	9
System Description .....	10
Comparison to Existing Products.....	12
Previous Coursework .....	13
Constraints .....	13
Design Constraints .....	13
External Standards.....	15
Tools Employed .....	15
Environmental Impact and Sustainability .....	16
Health and Safety .....	16
Ethical, Social, and Economic Concerns .....	17
Intellectual Property Issues .....	17
Detailed Technical Description of Project.....	18
System Overview .....	18
Hardware .....	18
Firmware .....	25
Project Timeline.....	28

Test Plan.....	30
Metric Testing .....	30
Electrical Component Testing.....	37
Final Results.....	38
Summary of Success Metrics .....	38
Fulfillment of Objectives .....	39
Final Grade.....	42
Costs.....	43
Future Work .....	44
References.....	44
Appendix A.....	50
Appendix B .....	56
Sensor Testing Configuration.....	56
Distance Sensing .....	58
Speed Sensing .....	58
Intuitive Notification.....	59
Waterproof Testing .....	66

## Table of Figures

Figure 1. Objective Tree Showing Project Deliverables Outlined in Green.....	9
Figure 2. System Block Diagram.....	10
Figure 3. Component Placement on Bike .....	11
Figure 4. MPPT Circuit Schematic.....	18
Figure 5. Linear Regulator Circuit.....	19
Figure 6. Linear Voltage Regulator Circuit .....	19
Figure 7. LED Driver Circuit Schematic .....	20
Figure 8. 3D Render of PCB Layout .....	21
Figure 9. Side View of Front Mount.....	22
Figure 10. Bird’s eye view of LED front Mount .....	23
Figure 11. Side View of Back Mount Printed Box.....	24
Figure 12. Bike Rack [50].....	25
Figure 13. Software flow diagram for TIMER_B0 .....	28
Figure 14. Project Task Deliverables and Primary and Secondary Responsibilities.....	29
Figure 15. Initial Gantt chart from project proposal.....	29
Figure 16. Final Gantt Chart .....	30
Figure 17. Experimental Setup for Sensor Measurement Testing .....	31
Figure 18. Measured Distance vs. Car Position for Sensor Validation .....	32
Figure 19. Measured Speed vs. Car Speedometer for Sensor Validation.....	33
Figure 20. Responses from 18 target users asked to identify if a signal was changing urgency ..	34
Figure 21. UART verification displaying data transfer .....	36
Figure 22. TIMER_B0 interrupt PWM signal with a 20 Hz Frequency.....	37
Figure 24. Handlebar mount for LED Display .....	50
Figure 25. Back View of Back Mount Printed box .....	51
Figure 26. Top View of Back box .....	52
Figure 27. Construction of Back Box .....	53
Figure 28. Securing of Bike Rack.....	54
Figure 29. Laser Cutting Process .....	55
Figure 30. Identification of the sensor in Windows Device Manager .....	56
Figure 31. Default configuration to read OPS 243-C sensor data via PuTTY terminal .....	57
Figure 32. Characterization of car movement for a signal of increasing frequency/urgency .....	64
Figure 33. Characterization of car movement for a signal of decreasing frequency/urgency ....	65
Figure 34. Back Box Waterproof Testing with Napkin.....	66
Figure 35. Front Box Waterproof Testing with Napkin .....	67
Figure 36. A Dry Napkin After Removing it from the Front Box .....	68
Figure 37. A Dry Napkin After Removing it from the Back Box .....	69



**Table of Tables**

Table I. Similar Existing Products ..... 12  
Table II. Distance from Bike to LED Frequency ..... 27  
Table III. Summary of Project Success Metrics ..... 38  
Table IV. Conversion from point value to letter grade ..... 39  
Table V. Summary of objective categories and points awarded totaling 35 points..... 42  
Table VI. Final Total Cost of Sentinel..... 43  
Table VII. Distance sensing verification data..... 58  
Table VIII. Data for sensor speedometer verification ..... 58

## Abstract

Bikes are used across the world for fitness, recreation, and sustainable transportation. However, this fantastic utility is hampered by the risk presented by motorists on the road. Bike crashes can be catastrophic for cyclists: 843 people were killed in bicycle-car accidents in 2019 alone [2]. To address this problem, we have invented a simple bike radar unit that helps protect cyclists from rear-end collisions. Using radar and an intuitive display unit mounted on the handlebars, the unit alerts cyclists of approaching vehicles long before they pose a risk, allowing riders avoid potential hazards. This device is designed specifically for riders who use bicycles for their daily commutes as well as people with auditory impairments which prevent them from interpreting auditory queues. The system can generate enough energy from our solar panel on a worst-case day to accommodate nearly all commuting use cases.

## Background

### Statement of Objectives

Biking improves physical health, increases time outdoors, and is a cheaper and more environmentally friendly alternative to cars. However, biking also presents risks: riding in severe weather, hard terrain, and the potential for a crash. In a survey of over 1000 bicyclists, health benefits ranked as the top motivation for riding a bicycle, whereas the crash risk ranked the greatest discouragement [3]. Our product would aim to address this concern and increase bike safety so that riders can cycle with a greater sense of security. The objective tree in Figure 1 divides the project's goal into 7 specific deliverables. These specific deliverables appear in the leaf nodes of the tree and are highlighted in green.

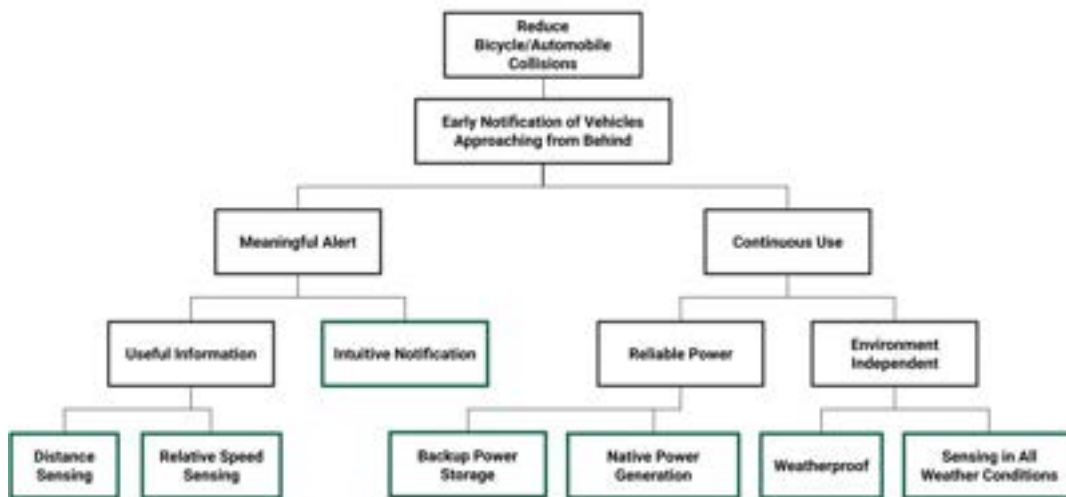

Figure 1. Objective Tree Showing Project Deliverables Outlined in Green

An intuitive display will alert the user of the distance and relative speed at which vehicles approach from behind. The device will accurately sense distance in various weather conditions. A solar panel will charge a backup battery that can be recharged independently of the solar charger.

According to the US Census Bureau, “the average bicycle commute time is 19.3 minutes, and most bicycle commutes” are “between 10 and 14 minutes” [4]. Thus, our system must harness enough solar power to accommodate at least two 20-minute commutes per day. With this in mind, we will design our system to charge enough for three 20-minute commutes per day to account for non-ideal weather and charging conditions.

## System Description

The block diagram in Figure 2 describes the overall system configuration with its major power and logic connections.

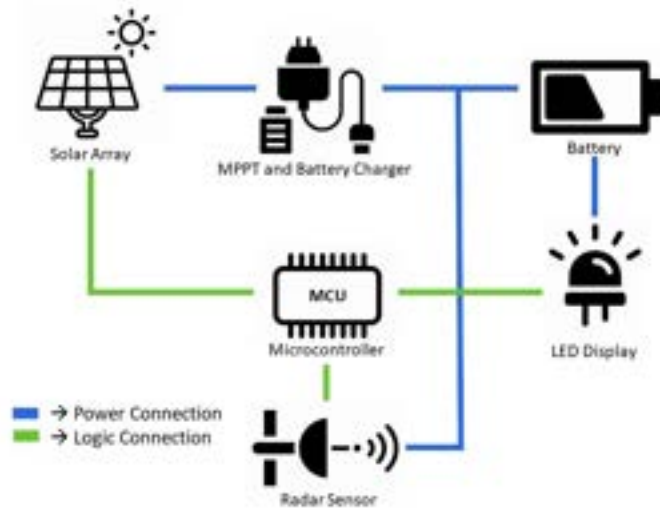

*Figure 2. System Block Diagram*

To detect and measure approaching objects, an OmniPreSense OPS243-C-FC-RP (OPS) radar sensor is mounted on the back of the bike. An MSP430F5529 [5] microcontroller reads the output signals from the radar. Sensor data is communicated via UART interface and includes motion detection, speed, and direction (inbound/outbound) [6].

As a car approaches a cyclist from behind, a series of LEDs mounted on the handlebars of the bike alerts the rider. An LED was chosen for the display system over an LCD/sound display for two reasons. First, a flashing light draws more attention than text on a screen. Second,

bike riders sometimes wear headphones, making auditory signals pointless. The display is controlled using PWM signal to drive transistors on the LEDs. Figure 3 illustrates the placement of the display on the bicycle.

The entire system is powered by a rechargeable battery. A maximum power point tracker (MPPT) control system is used to charge a battery using a Renology solar panel [7]. Additionally, the batteries can be recharged independently of the solar panel if a user uses more power in one day than is generated by the solar panel. The battery provides power to the radar sensor, microcontroller, and LED display.

The battery is comprised of 2 lithium-ion 18650 cells [8], connected in series. The combined cells produce a final nominal voltage of 7.4V. This battery pack feeds into a buck regulator [9] which produces a regulated 5V rail to power our sensor and LED display. Using the 5V rail, a linear regulator [10] produces a stable 3.3V rail for the microcontroller. The battery system powers the LED display, microcontroller, and radar sensor. The worst-case power draw for these three components was measured to be 2.3W. With a total usable capacity of 13Wh, the battery system will be able to supply the system's worst case power draw for over 5 hours.

A ~2 m wiring cable [11] is routed from the back of the bike to the handlebars to provide power and control signals to the LED. All mounts for the electronics are 3D printed. As the radar sensor uses a 24 GHz transmitter, it can be placed behind plastic for weatherproofing and still function as expected. The placement of the display is shown in Figure 3.

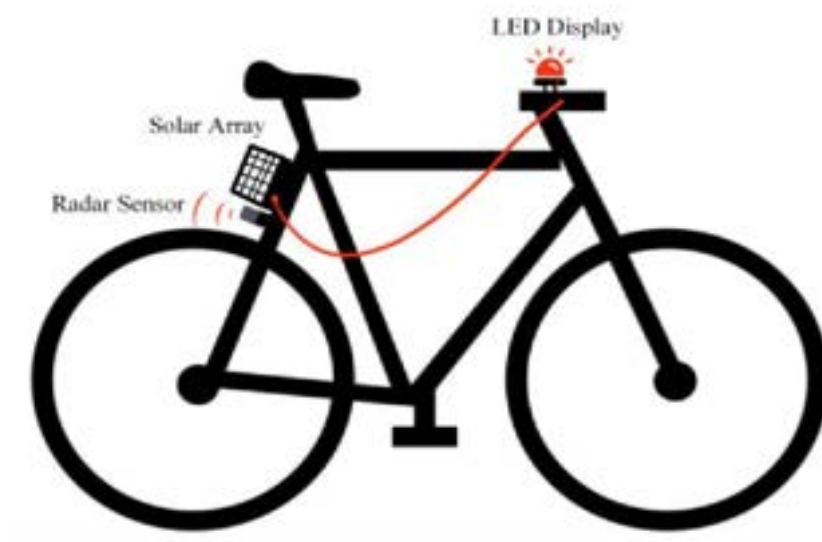

*Figure 3. Component Placement on Bike*

## Comparison to Existing Products

There are several products on the market that address similar problems of bike safety and prevention of car and bicycle crashes. On the low-tech side of products, bike mirrors can be mounted to a bicycle and are relatively affordable and accessible [12]. However, like car mirrors, these mirrors can have blind spots and require a rider to constantly scan for oncoming cars. It was found that collision detection systems in cars have reduced bodily harm claim frequency by 27 percent [12]. The car detection systems are more robust than the bike sensor proposed but similarly use sensors to notify drivers of incoming cars and or pedestrians and have a clear advantage over mirrors for safety [12]. Table I summarizes differences between the current products on the market and scholarly articles and their respective prototypes.

Table I. Similar Existing Products

Commercial Product or Literary Paper Reference Number	Similar Completed Prototype [13]	<i>Garmin Varia</i> ™ [14, 14]	Bike Mirror [15]
Purpose	Detecting cars from behind and turning onto bike	Detects oncoming cars from behind and alerts rider	Provides visibility of objects behind rider
Sensors	Sonar Radar	Radar	None
Connection from Sensor and Alert	None	Bluetooth	None
Cost	500	200	~\$20
Range	6m	140m	~60m
Alert	None	<i>Garmin Edge</i>	None

Radar collision detection products for bicyclists exist on the market, including the *Varia*™ by *Garmin*, a radar car detection system [14]. The *Varia*™ by *Garmin* uses a bike seat mounted radar with a 20° FoV (field of view), a battery life of 6-16 hours, and sensing range of 140 m for vehicle speeds of 10-160km/hr. It also can detect up to 8 cars. The radar communicates via Bluetooth to the *Garmin Edge* device, a GPS computer with an LCD screen mounted on the front of the bike [14]. The *Varia*™ by *Garmin* is one of the only radar devices for vehicle detection on the market.

This capstone project is a novel idea, in its power source and simplicity of signaling to bike rider. Unlike the *Garmin* product, our project design would not need to be connected to another separate display system. *Garmin's* products require the customer to buy both the sensor and the main bike navigation control. If a customer bought both the *Varia*™ sensor, *Edge*

device, and the associated mounting kits, the cost would be around \$500 [14] - the Sentinel also costs 500 dollars. Unlike the Varia™, the rider would not need to order multiple parts or worry about connecting each component together. The simplicity of the capstone LED display also reduces the amount of data being presented to the rider. Unlike the Varia™, the capstone project will be solar powered.

## **Previous Coursework**

The previous course work in both computer engineering and electrical engineering will be vital in the success of this project. The Fundamentals courses (ECE 2630, ECE 2660, ECE 3750) taught circuit design, PCB design, and circuit construction. They also taught key project design skills: meeting specifications, systematically recording results, verifying, and debugging. This process was practiced over and over in labs and final projects. These skills are essential to organize the design challenge, tackle technical tasks, and work coherently as a group. The solar panel system and corresponding PCB design rely heavily on these courses. Secondly, the Intro Embedded Computer System course (ECE 3501 and ECE 3502), and the Advanced Embedded Systems course (ECE 4501) taught the concepts of programming Microcontroller Units (MCUs). Programming MCUs will be essential in processing incoming radar data and communicating that information to the lighting display, as well as controlling the scheduling for all these processes to occur seamlessly. The Electromagnetic Energy Conversion (ECE 3250) course and its concepts of maximizing power and efficiency will be used to create a low power system that can run on a small solar panel. Lastly, the Science, Technology, and Society courses (STS 1500, STS 2000, and STS 4500) have explored the greatest engineering inventions and their impact and place in society. These teachings will help to better design the bike sensor not only to meet the purely technical requirements but to create a device that navigates the societal factors: ethical, environmental, and economic, that will determine the effectiveness of the design in society.

## **Constraints**

### **Design Constraints**

#### **CPU Limitations**

The microcontroller selected was the Texas Instruments MSP430F5529 [5]. This is a powerful MCU with capabilities of having a 25MHz clock speed as well as multiple peripherals that are capable of UART and pulse width modulation (PWM). However, the group's task was to conserve power, which limited the clock speed to 8MHz. This decision was made as there needed to be a tradeoff between power consumption as well as selecting a clock speed fast enough to create a stable baud rate for the UART connection.

#### **Software Limitations**

In terms of software, the group used KiCAD for designing the circuits as well as the printed circuit boards (PCBs). Texas Instruments' integrated development environment (IDE), Code Composer Studio (CCS), was used for writing the necessary C code, flashing the code onto the MSP430, and debugging purposes. CCS is a very powerful software and was useful throughout most of development; however, debugging became troublesome as the register window cannot read values on the MSP430 unless the code execution is paused. This can make analyzing program execution quite troublesome.

PuTTY 0.76 SSH [16] was used in order to interface with the radar sensor. This was done by connecting the sensor to a laptop via a USB cable. Once connected, the user can type commands into the PuTTY terminal that are then used to reconfigure the sensor settings. The list of commands can be found in the sensor API interface [17].

### **Solar and Power Constraints**

Solar constraints are mainly rooted in the limited solar irradiance available on Earth. At the equator in ideal conditions, about  $1\text{kW}/\text{m}^2$  of solar irradiance is available, but at Charlottesville's latitude, this can drop to under  $300\text{W}/\text{m}^2$  during the winter. This created three primary constraints – choosing a large enough solar panel, harvesting and processing energy in an efficient way, and consuming as little power as possible. Fundamentally, any device that relies on energy harvesting must be conscious of its power consumption. This makes developing a power budget for the device more challenging than it would otherwise have been.

### **Manufacturing Limitations**

Sentinel used a commercially available OmniPreSense OPS243-C-FC-RP radar sensor. The size of the OmniPreSense sensor determined how big our final PCB was. Furthermore, the Sentinel prototype interfaced with the MSP430 via header pins instead of an embedded chip on the PCB, which would reduce size and cost. Furthermore, our team only had access to 3D printers to fabricate our project. In the future access to tools such as drills and laser cutters would be beneficial.

### **Economic and Cost Constraints**

The budget provided for the UVA Electrical and Computer Engineering Capstone was \$500. The budget is the main limiting factor on what kind of and how many sensors we could buy for our project. Once cost reduction to our system is we were able to get microcontrollers for free and we were able to 3D print several mounts for our project.

### **Physical Mounting Constraints**

The sentinel faced several physical mounting constraints. Firstly, the front mount and back mount need to be rigid and unmoving. Additionally, the 3d Printed boxes needed to have a footprint smaller than the printing footprint of the Ender Pro 3 printer [18]. The printed circuit

boards needed to fit inside the boxes and have correctly placed screw holes. Next the waterproof connector [19] had to have a correctly sized hole for waterproofing and enough room to place wires within the entire 3d printed enclosures. The front box printed box needed to accommodate mounting adhesive patch from the bike mounting kit [20]. For time saving and material aging purposes the walls of the enclosure could not be more than .2 inches. The back box needed to accommodate the thickness of the MSP, power board, and sensor. The bicycle rack needed to be a universal fit for standard bicycles.

## **External Standards**

UART: (Universal Asynchronous Receiver-Transmitter) - A UART implements serial communication asynchronously between a transmitter and a receiver device [1].

NEMA3: outlines the waterproofing standard for outdoor electronics. Casings must protect against windblown dust, rain sleet and snow [21].

IPC Standards for PCB Design: IPC-2221A sets standards for the part and track spacings on the PCB designs [22]. IPC-A-600F sets acceptance criteria for PCBs, including board edges, material, holes, plating, and solder mask [23].

## **Tools Employed**

### **Hardware**

In order to test our circuits and connections, the group used National Instruments' VirtualBench [24]. Every member of the group has had to go through numerous classes that have taught us how to properly use this device. As a result, the Virtual Bench was used to collect all information necessary for signal verification.

The Sentinel product has many enclosures that were created in order to properly protect the device. As a result, the group printed these enclosures using the Ender 3D Pro [18] printer.

To make the enclosures weather resistant and obtain a professional level of appeal, the Universal Laser Systems PLS6.150D laser cutter [25] was used to precisely cut the plexiglass necessary to place on the casing of the system devices.

### **Software**

Julia Rudy and Brandon both used Texas Instruments' Code Composer Studio [26] integrated development environment (IDE) in order to develop the code base for the system. They chose this IDE as it provides extensive debugging tools as well as a sense of comfort as both have used the tool before.



Rex chose to use *KiCad*, ver. 5.1.10 [27] for circuit design and PCB layout. This software was chosen as Rex has done numerous internships and personal projects that have caused him to use this development tool.

Solidworks [28] was used in order to create the 3D models that needed to be printed. Cura Ultimaker [29] was used for setting up 3D prints from the models designed in Solidworks.

PuTTY 0.76 SSH [16] was used to read sensor data via USB connection on a laptop.

## **Environmental Impact and Sustainability**

The power source for the sensor will be a mono-crystalline solar panel. Solar panels offer a renewable source of energy, however, the creation of said panels can be energy intensive. Unlike multi-crystalline panels, mono-crystalline panels offer higher efficiency: 16-22% commercially compared to 15-18% of multi crystalline cells [30]. The production of the panels requires a significant input of energy, water, and rare materials [31]. If solar panels are improperly disposed, they can leach into the soil and create pollutants to water sources [32]. Studies have found solar panel's environmental benefits outweigh the initial costs. Solar panel companies also have recycling programs to properly dispose the panels. Some of these companies in the US include: 3 R Recycling, Cleanlites Recycling, and Echo Environmental [33]. The use of recycling programs can reduce the amount of waste. Following the EPA's guidance on the disposal of solar panels can help to increase the benefits of using solar panels [34].

Another aspect of the environmental impact of the design is the plastic enclosure of the mounting. 3D printers are highly specialized machinery and require several electronic components and energy to run. These factors are countered by high use of the machine and studies have shown that specialized prototyping can reduce waste; however, this is all dependent on specific use and materials used in the print. One of the major sources of waste for 3D prototyping is unusable prints [35]. As a team we will carefully plan the print to reduce error and the possibility of having to reprint the prototype.

## **Health and Safety**

Sentinel's primary goal is to help those with hearing impairments. Our group must make sure that our system is extremely reliable. If the system partially works, in the sense that it detects oncoming vehicles most of the time, the user may become extremely reliant on the system. This could be problematic if our system degraded over time and malfunctioned, leading the user to not know about the oncoming vehicle. Which in turn, would lead to many accidents and cause our system to become a liability rather than an assistive tool.

The 95<sup>th</sup> percentile human reaction time as used in car crash reconstruction is 1.6 seconds [36]. Conservatively estimating this number to be 2 seconds with a speed difference of 50mph (22.352 m/s) between a bike and an oncoming car, we find that our notification system must be able to detect objects when they are approximately 40 meters away. Therefore, our system will be designed to warn riders of approaching cars when they are at least 40 meters away. Another safety concern is the power wire getting caught in the wheels of the bike. The project's power cable will run alongside the brake cable of the bike to prevent the wire from getting caught. Another safety concern is if the electronics are not waterproof, presenting a shock hazard. Therefore, all electronics are waterproofed using NEMA standards [21].

## **Ethical, Social, and Economic Concerns**

Ethical issues surrounding this project are heavily linked to the health and safety section seen above. When creating a device with the intent to protect the safety of people, the engineers responsible for the design must be extremely thorough. This project also caters to those who are hearing impaired. Over 360 million across the world suffer from some form of hearing loss [37]. If our group does not properly design and test the system, then our consumers could face the risk of being severely injured.

Lastly, if an accident occurs when this device is in use. The question arises of who or what party is responsible. Companies like *Garmin*, have similarly weighed this ethical dilemma and as a result have issued all customers a disclaimer about the customer's responsibility for safe bike riding practices [38]. Since our device would not be making any autonomous driving choices also, the customer is fully in control of their bicycle and the driving decisions they make. We will make a similar disclaimer to those who use our bike sensor.

## **Intellectual Property Issues**

Our project is patentable. The most similar product to the Sentinel is the Varia by Garmin with patent number US10393872B2 [39]. However, the Varia is not solar powered, meaning the Sentinel has an independent claim that varies it enough from the Varia design to be patented. The Sentinel is the only solar-powered rechargeable car detection. Other products with similar functionality to the Sentinel exist such as patent US10748435 [40] and US8952799B2 [41] which use proximity sensors to detect oncoming obstacles.

Patent US10748435 is an obstacle avoidance system provided to assist a pilot in avoiding obstacles. The obstacle avoidance system includes a set of proximity sensors and a pilot interface device. The set of proximity sensors detects nearby obstacles by emitting a signal and receiving a reflected signal from an obstacle.” [40]

Patent US8952799B2 “is a method and system produce a warning signal to warn a driver of a vehicle about a potential obstacle crossing behind the vehicle for example, as the vehicle is backing out of a parking space.” [41].

Both patents deal with obstacle detection and notification. However, neither are used for bike riders, only other motorized vehicles like planes and cars.

## Detailed Technical Description of Project

### System Overview

Sentinel is a solar-powered car detection system. A solar panel mounted to the back of the bike provides power to the system. A radar sensor mounted to the back of the bike detects how far away obstacles are. This data is communicated from the radar sensor to the microcontroller via UART in JSON packets. The microcontroller parses the JSON packets. Based on how close the obstacle is to the bike, the microcontroller sets the frequency of LEDs mounted at the front of the bike.

### Hardware

#### Power PCB and Solar Interface

The core of the power PCB is formed by an Analog Devices LT3652 maximum power point tracker (MPPT) integrated circuit. The output of the solar panel is fed into the MPPT as shown in Figure 4.

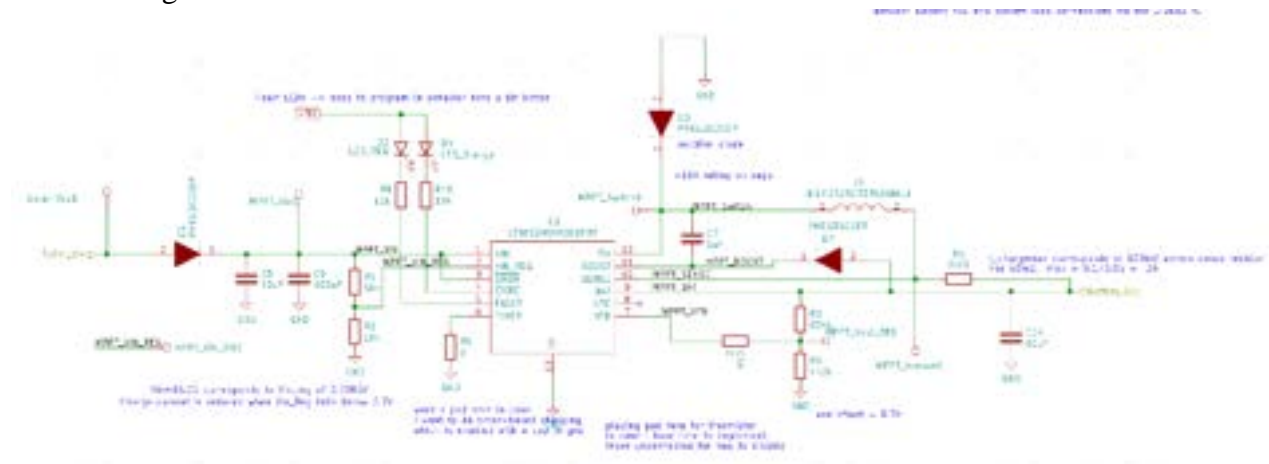

Figure 4. MPPT Circuit Schematic

This circuitry modulates the current draw from the solar panel in order to maximize its output power. It accomplishes this by varying the switching duty cycle through the inductor L1. It delivers power into two lithium-ion 18650 battery cells, which are wired in series to create a nominal voltage of 7.4V. The LT3652 circuit intelligently charges these battery cells as a function of their state of charge, preventing overvoltage, overcurrent, and undervoltage conditions.

The 18650 battery cells are then fed into a buck regulator, as shown in the schematic in Figure 5.

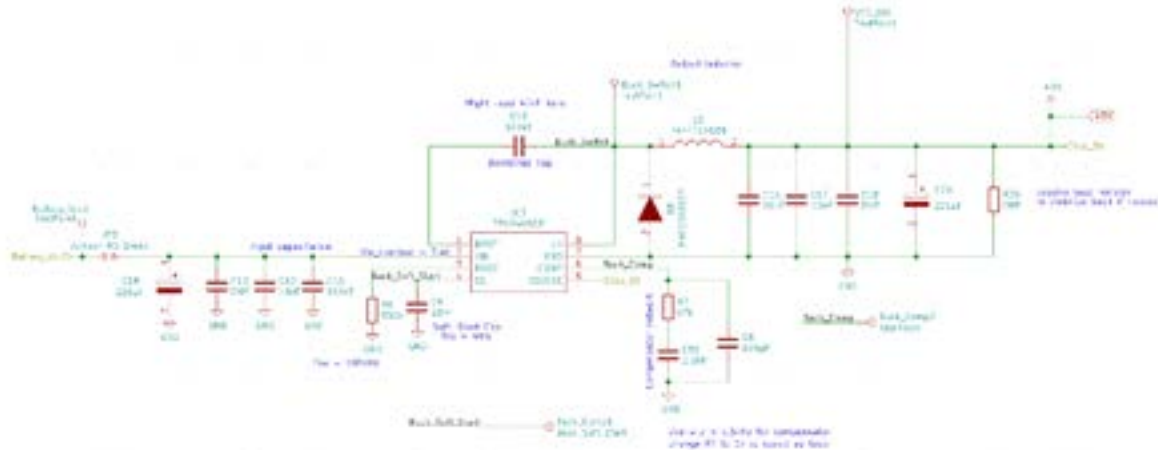

Figure 5. Linear Regulator Circuit

The voltage of the batteries varies throughout their state of charge, sometimes swinging even under 7 volts or over 8 volts. Because the radar sensor requires a stable 5V rail to operate, this buck regulator is needed to create a stable 5V rail. Using a Texas Instruments TPS5405 integrated circuit, this circuit utilizes the varying battery voltage to create a fixed 5V output. Finally, this 5V output is fed into a linear regulator as shown in Figure 6

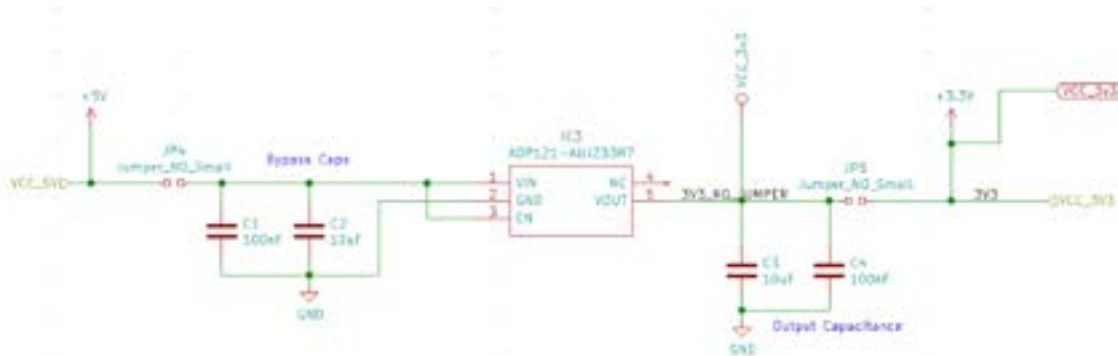

Figure 6. Linear Voltage Regulator Circuit

This linear simply creates a stable 3.3V rail to power the microcontroller. In addition to producing each of the power rails, the power PCB also drives the LEDs in the display board. It accomplishes this with the BJT driver circuit shown in Figure 7.

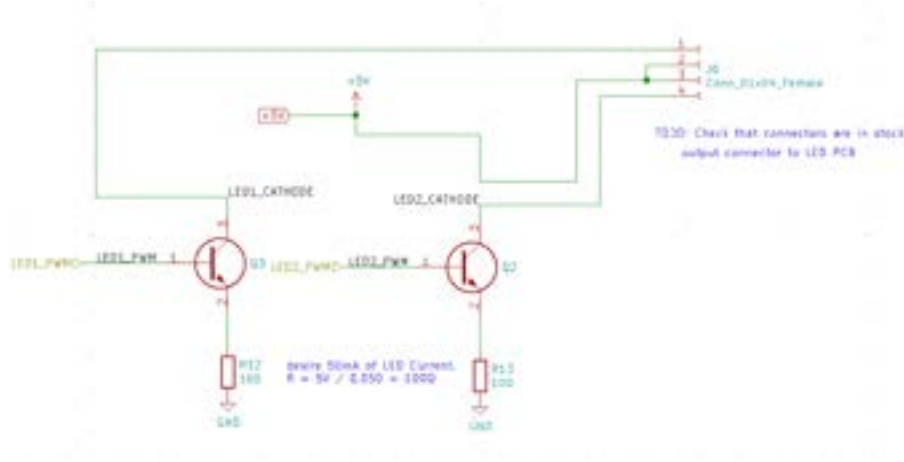
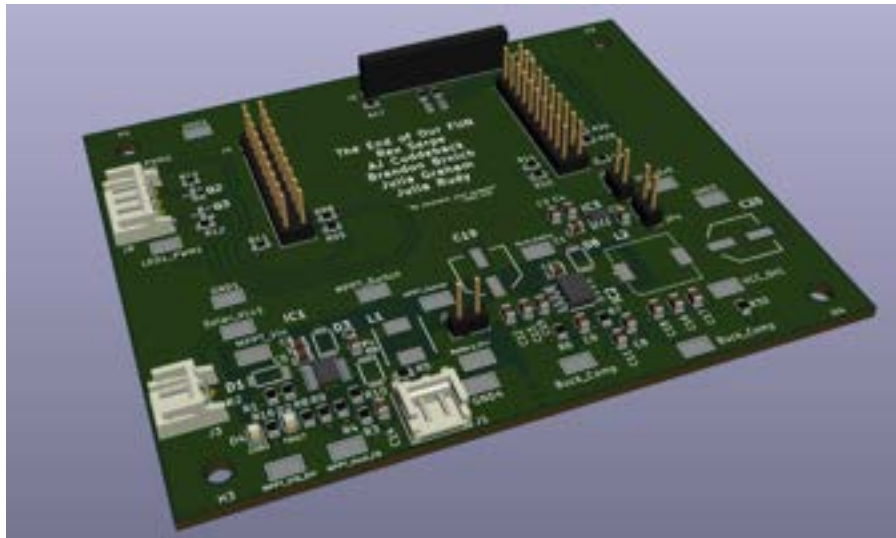

Figure 7. LED Driver Circuit Schematic

The base of each BJT connects to a PWM output of the MSP430 microcontroller. When the micro sets the voltage high, the BJT conducts and allows current to flow from base to emitter. Thus, a current flows through the LED determined by a current-limiting resistor located on the display board. When the voltage is set low, the BJT does not allow current to flow and the LEDs remain off. The power board and display board connect through the connector J6 pictured in the schematic above.

Finally, the power board has pin headers which allow it to interface with both the MSP430 microcontroller and the radar sensor. It also routes the required traces from the radar sensor to the MSP430, such as the UART RX and TX lines which carry information from the sensor to the microcontroller. A 3D render of the completed circuit board is shown in Figure 8.



*Figure 8. 3D Render of PCB Layout*

## **Sensor**

To properly read data from the sensor and obtain the information necessary to create the Sentinel, an interface needed to be created such that data could be passed from the sensor onto the MSP430. This was done by creating headers located at the top of our PCB board seen in Figure 8. After connected to the header pin, traces were made from the transmitter (Tx) pin of the sensor to the receiver (Rx) pin of the MSP430 header. As a result, data was able to properly flow between the sensor and our microcontroller.

## **Product Mounting**

The physical mounting of the sensor and the LEDs are critical to the functionality of the Sentinel. There were many considerations to be taken into account. Firstly, the enclosure of the Sentinel needs to be waterproof according to NEMA Standards [21]. Secondly, the mounting needs to be rigid and sturdy to accommodate the solar panel [7], LED display, and sensor [6] on a moving vehicle. The mounting most basically consists of a front mount and back mount.

### **Front LED Mount**

The front mount consists of a 3D printed enclosure as detailed in Figure 7, Heyco 3245 waterproof wire connector [19], jacketed wire [11], SimbaLux Acrylic Sheet Clear Cast Plexiglass top [42], 4 screws which attach the plexiglass to the printed enclosure [43], M3 screws to attach the front LED circuit board to the enclosure, flex tape [44] to further waterproof the box, and the Sincetop Bike Mount device [20]. The jacketed wires connect on each end to the PCB through a JST connector [45]. The first design step was to rigorously measure the associated components and determine design parameters. The size of the mounting adhesive from the mounting kit was measured as well: this product is shown in Figure

23 [20]. The front box was designed to have the respective PCB board sit inside the box while discretely connecting to the waterproof connector. In the creation of the 3D box Figure 9. Side View of Front Mount, the thickness of the walls needed to be modified in later revisions of the 3D print to reduce the required time for printing. The box was created using the Creality Ender 3 Pro printer [18] and Overture PLA Filament material [46]. Once the final revision of the box was created, the plexiglass [42] was cut using a laser cutting machine in the Architecture school [25]; this cutting was aided by DWG drawings created in Solidworks [28] [47]. The various components of the box were secured together using 3m screws from the connection of the PCB to box, Krazy glue [48] was used to provide further support to the waterproof connector joint, and Flex Tape [44] was used around the top edge of the box to ensure a tight waterproof seal. Lastly the enclosure was connected to the bike with the Sincetop Bike Mount [20].

The Front LED Mount is pictured in Figure 9 and Figure 10. The front mount is a 3D printed PLA box, with a flat piece of plexiglass screwed onto the top. The LED Display is screwed to the inside of the mount. A Heyco 3245 waterproof wire connector [19] is used to waterproof the wire connection on the bottom of the mount. In future renditions, the 3D print would include a lip around the seam of the plexiglass, to prevent water from getting in.

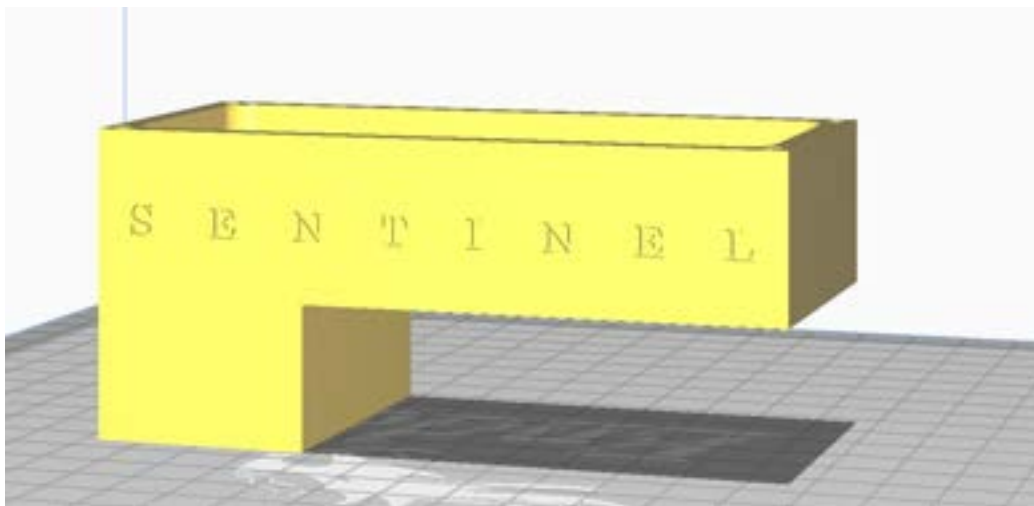

*Figure 9. Side View of Front Mount*



*Figure 10. Bird's eye view of LED front Mount*

### **Back Mount**

The back mount consists of a 3D printed enclosure as detailed in Figure 11, waterproof wire connector [19], jacketed wire [11], plexiglass top [42], 4 screws, M3 screws, flex tape to further waterproof the box, zip ties [49], bike rack [50], and Krazy glue [48]. The jacketed wires connect on each end to the PCB through a JST connector [51]. The first design step was to rigorously measure the associated components and determine design parameters. The x y and z dimensions of the sensor [6], power PCB, and MSP connection were measured. Additionally, the size of the battery pack was also measured. The 3D printed PLA box was designed to have the sensor facing the rear and to sit inside the box while allowing room for connection to the waterproof connector. In the creation of the 3D box, the thickness of the walls needed to be modified in later revisions of the 3D print to reduce the required time for printing. The box was created using the Creality Ender 3 Pro printer [18] and Overture PLA filament [46]. Once the final revision of the box was created, the plexiglass was cut using a laser cutting machine in the Architecture school: this cutting was aided by DWG drawings created in Solidworks [28]. The various components of the box were secured together using 3m screws for PCB to box, Krazy glue [48] was used to provide further support to the waterproof connector joint, and Flex tape was used around the top edge of the box to ensure a tight waterproof seal. Lastly the enclosure was connected to the bike with the zip ties [49] to the bike mount [50].

The Back Mount is pictured in Figure 11. In future renditions, the 3D print would include a lip around the seam of the plexiglass, to prevent water from getting in. Additionally, the assembly process is shown in Figure 26.



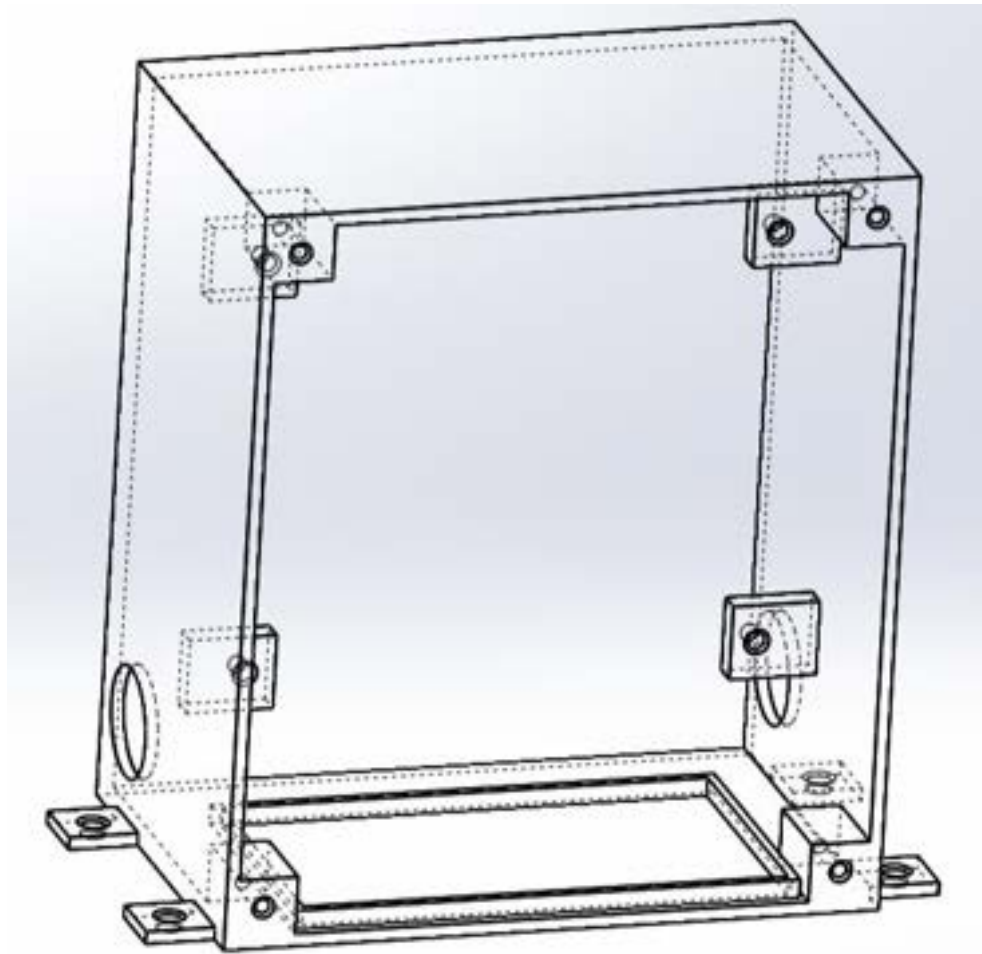

*Figure 11. Side View of Back Mount Printed Box*

### **Bike Rack Installation**

The last portion of the mounting was to secure the bike rack [50] onto the back wheel. The bike rack [50] [11] was chosen because it fits most standard bicycle sizes. The screws that came with the bike rack were insufficient to ensure a sturdy connection. Additional nuts and bolts: size 6 and 8 were used to create a rigid connection [43]. The bike rack [50] is pictured in Figure 12. Also shown is the final product of the mounting to the struts of the bike. Additionally, the Solar Panel [7] was attached via plexiglass [42] and zip ties [49] to the rack.



*Figure 12. Bike Rack [50]*

## **Firmware**

### **UART**

To read incoming data from the radar sensor, UART needed to be configured on the MSP430. To begin this configuration, the respective I/O ports for the transmitter (Tx) and receiver (Rx) needed to be identified. Referring to the sensor datasheet [6], it can be seen on page 26 that the pins 3.4 and 3.3 correspond to the Rx and Tx for UART, respectively. These pins then needed their SEL bits set to 1 to enable the UART module function. Next, the respective UART registers needed to be configured such that the specifications for communication amongst the sensor and MSP430 were the same. Looking at the datasheet of the radar sensor, each data packet is configured to have 8-bits, one stop bit, and no parity bit. The MSP430 is specified to have this same configuration by setting the CTL0 register to have bits

UCPEN and UCSPB set to zero. In doing so, the MSP430 knows each packet will have no parity bit and only one stop bit. Continuing with the configuration, the baud rate for the MSP430 must be set such that it is the same as the sensor. From the sensor datasheet, it can be seen it can handle baud rates ranging from 9600 through 230,400. The MSP430 is also capable of achieving this range of baud rates. However, to balance power consumption and efficient transfer of information, the group selected a baud rate of 115,200. This is an extremely quick baud rate and can be maintained with the 8MHz clock signal the MSP430 is using. To obtain these baud rates, registers UCA0BR0 and UCA0MCTL needed to be configured based on the following equations found on page 950 of the MSP430 datasheet:

$$N = \frac{f_{BRCLK}}{BaudRate}$$

$$UCA0BR0 = INT\left(\frac{N}{16}\right)$$

$$UCBRS = round[(N - INT(N)) * 8]$$

The value given from the UCBRS is what needs to be loaded into the UCA0MCTL register. From these equations, the following values are obtained:

$$N = \frac{8000000}{115200} = 69.4444$$

$$UCABRO = INT(69.444) = 69$$

$$UCBRS = round[(69.444 - 69) * 8] = 4$$

Once these values were found and their respective registers were set, the last part of the UART configuration was to enable interrupts to occur when the Rx buffer was full. This was done to allow the group to configure an interrupt service routine (ISR) to occur every time data was sent from the sensor to MSP430.

Within the ISR, the bit values taken from the register were cast into characters. Once the character representation was obtained, it was compared to the open bracket, '{', to indicate if this is the beginning of packet or not. If the character is an open bracket, then the index into the buffer would be set to 0 to signify the start of the JSON packet. In this conditional, a global Boolean is set to tell the periodic thread that parses the JSON packet that the buffer is not ready to be parsed yet. This precaution is taken to prevent parsing invalid strings which would lead to improper functionality of the system. Furthermore, another Boolean is set to true to tell the ISR that any data after this can be placed in the buffer. From this point forward, any data can be read into the buffer up until the closing bracket, '}', is detected. When the closing bracket is detected,

it is placed in the buffer, and the buffer ready conditional is set to 1 to indicate to the periodic decode thread that this buffer is full and ready to be parsed.

When the code was first written, upon each interrupt triggered on the Rx pin, data would be copied into the buffer if it found itself within the two brackets. However, this is inefficient and waste clock cycles as data is constantly being written; due to the buffer ready conditional, this could cause the frequency of the LEDs to never change as it could always block it. Therefore, another conditional was introduced into the UART ISR. This conditional was set via the periodic decoder thread to indicate that another was ready to be received. As a result, a JSON packet is placed into the buffer and decoder every 50 milliseconds.

### JSON Parser

Figure 13 shows a flow chart of the period interrupt implemented. This interrupt waits until the buffer is finished copying the JSON data. If the buffer is ready (`buffRead == 1`), then the interrupt decodes the JSON data located in the buffer. The `jsmn.h` library [52] was used to parse the JSON data. The interrupt checks if the moving average of range data is within an experimentally determined threshold. This is to filter out any unexpected jumps in data. If the data is within the threshold, the sensor's range value reading is mapped to a LED blinking frequency as seen in Table II. The closer the car is to the rider, the faster the LED will blink. The flag `buffReady` is set to 0 to indicate the buffer is no longer ready. The `wantData` flag is set to 1 to indicate that a new buffer of data is ready to be filled.

Table II. Distance from Bike to LED Frequency

Distance From Bike (m)	LED Frequency
0 - 5	Fast Blinking
5 - 15	Medium Blinking
15 - 30	Slow Blinking
30 and above	LEDs are off

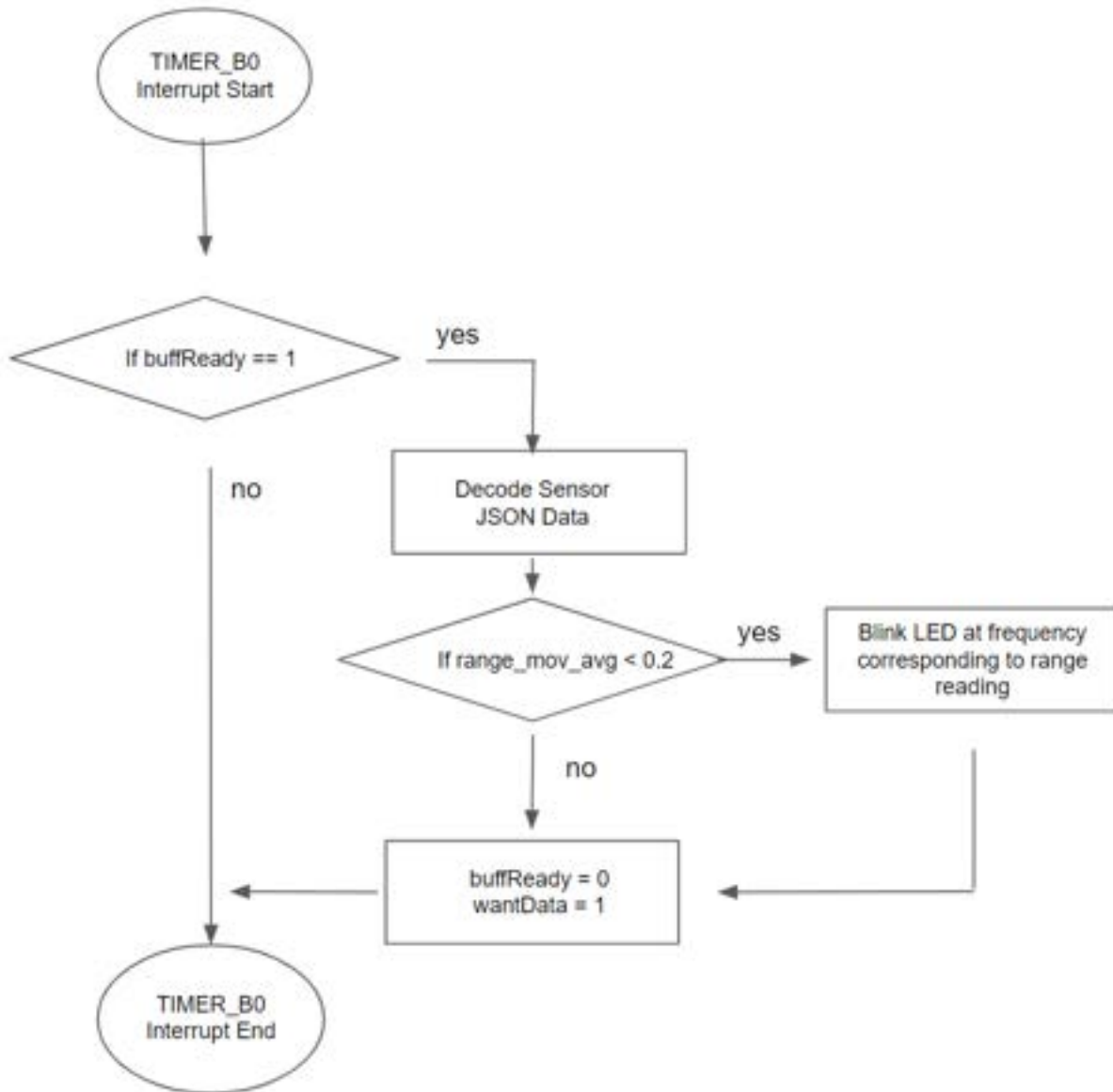

Figure 13. Software flow diagram for TIMER\_B0

## Project Timeline

Figure 14 shows the project task objectives broken into technical deliverables. The table outlines the team's primary and secondary responsibilities as described in the project proposal. It is important to mention that some responsibilities did shift as the project progressed.

Specifically, Rex’s primary role became to design both the power supply as well as the PCB for it. The reason for this is that the two tasks were so similar that having one team member design the system and another build the PCB would prove to be extremely inefficient. Therefore, the group decided to shift AJ’s primary role to overall system level design and testing.

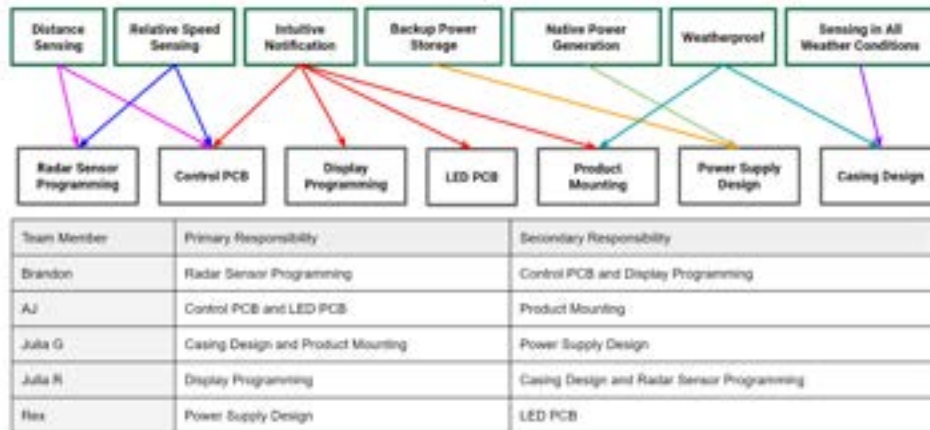

Figure 14. Project Task Deliverables and Primary and Secondary Responsibilities

Figure 15 shows the initial Gantt chart for the project. Figure 16 shows the final timeline. Many projected deadlines were shifted to later in the semester as we waited for components to arrive (product mounting and waterproofing). Furthermore, decoding the sensor data took longer than expected. Overall, tasks were able to be completed in parallel and on time once all the components arrived.

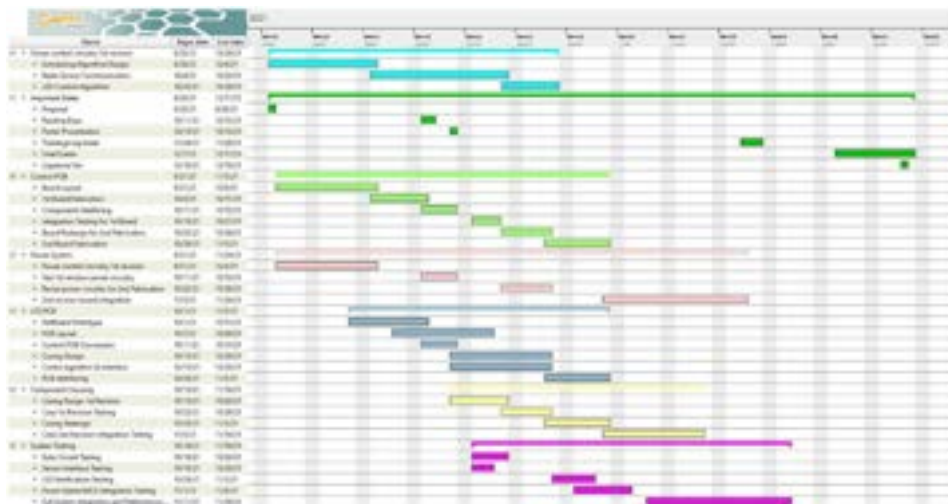

Figure 15. Initial Gantt chart from project proposal

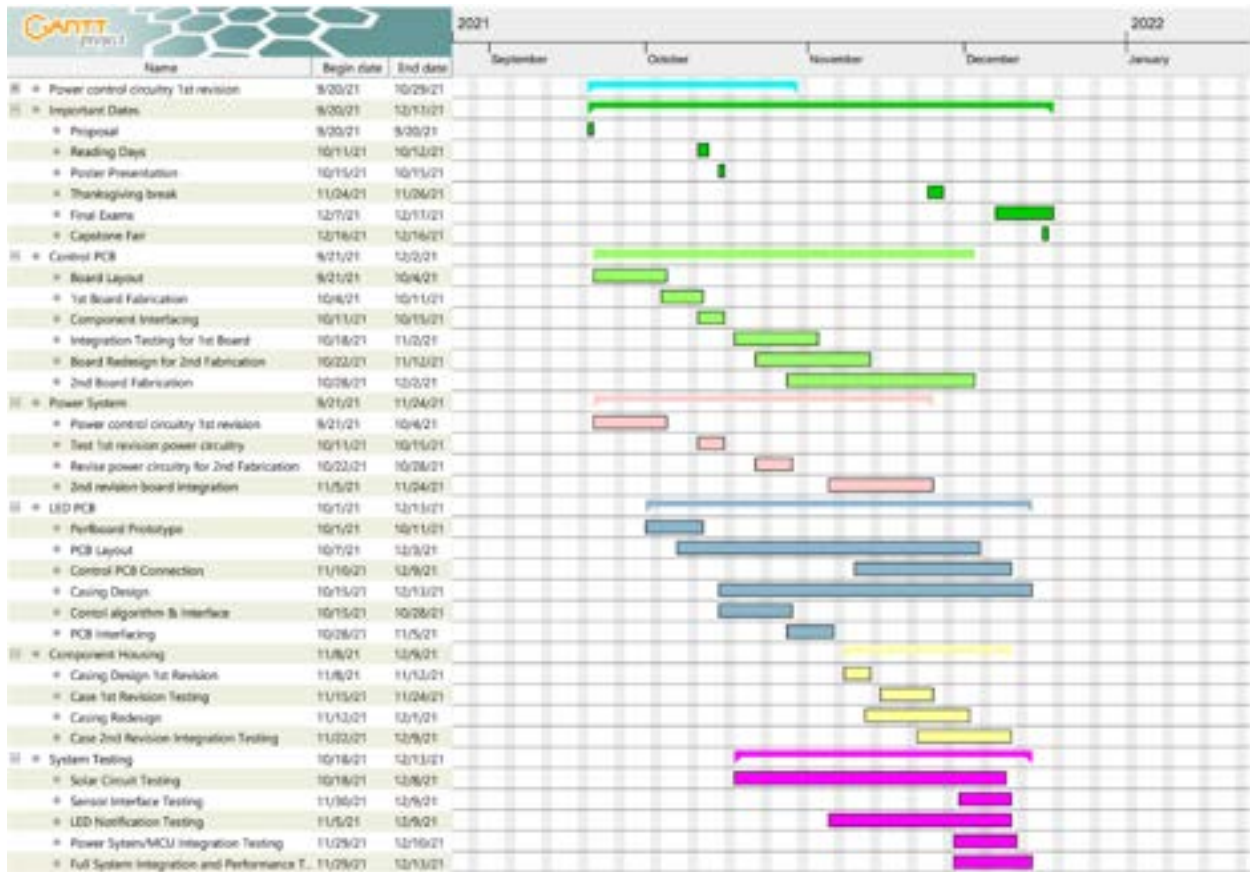

Figure 16. Final Gantt Chart

## Test Plan

### Metric Testing

### Distance Sensing

Testing the distance is used to determine areas where the sensor is susceptible to signal noise and to establish the outer limits of our sensor's ability to detect objects. This information is used to set the sensor range filters and the bounds of our distance to flash frequency map for our notification algorithm.

Testing sensor performance requires measuring how the sensor measures the presence of cars in its field of view. This test requires a car with a hatchback to serve as the observation point, an additional car to serve as the test subject, a parking lot with standard space markings, a tape measure for taking distance measurements, a computer and serial communication client for reading the data, a USB cable, and the sensor. The serial communication client we used is

PuTTY version 0.76 [16] and a detailed description of measurement configuration can be found in



Appendix . This procedure is repeated in both sunny and rainy/cloudy weather to verify that the sensor can perform in a variety of weather conditions.

To make consistent distance measurements we lined the sensor up with the border of a parking space and measured the width of the parking space to allow for quick calculation of observation position. For each measurement, we counted the full number of parking spaces within that distance and then measured the remainder of the distance from the last parking space line. For example, to measure 10m we counted three 2.72m parking spaces and finished by measuring an additional 1.84m to reach 10m (as shown in Figure 17).

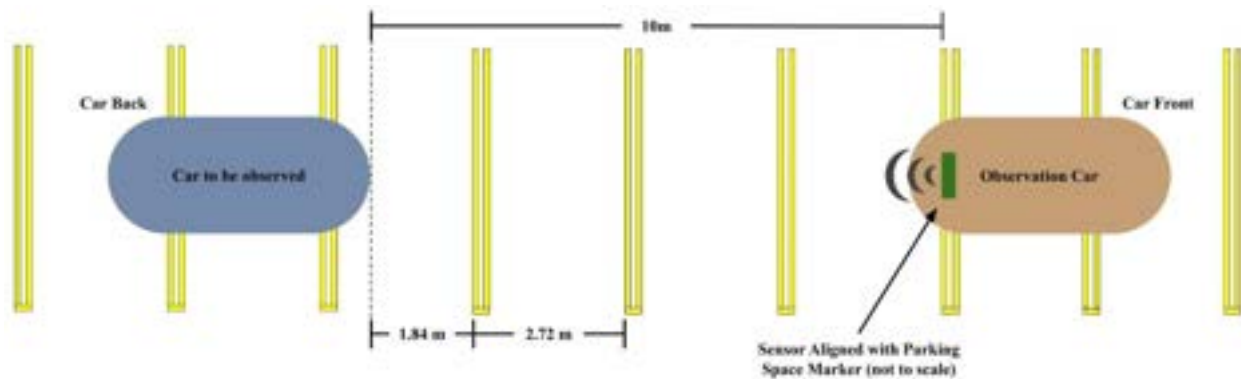

*Figure 17. Experimental Setup for Sensor Measurement Testing*

In the lab we noticed noise near the sensor so we first started by placing the car 10m away from the sensor to determine what noise near the sensor might prevent it from reading properly. With nothing directly in front of the sensor it consistently read 0.9m rather than picking up the car set at 10m. To rectify this problem, we set a filter at 1.5m at which point we started measuring the car at 10m. We then took measurements at 1.6m, 10m, 20m, 30m, and 40m to verify that the sensor reading scaled with car position and could detect cars at 40m, the maximum range of the sensor [6].

Our initial plan was to test in both rainy and sunny weather. During distance testing for rainy weather, however, the rain stopped and yielded a fully overcast sky. Rather than stopping the experiment, we continued to take measurements to determine if the sensor would exhibit consistent behavior despite the change in environment. The resulting data was consistent both within the rainy/cloudy weather experiment and across the rainy/cloudy and sunny weather experiments. A complete table of the data can be found in Table VII in

Appendix . The data are graphed in Figure 18.

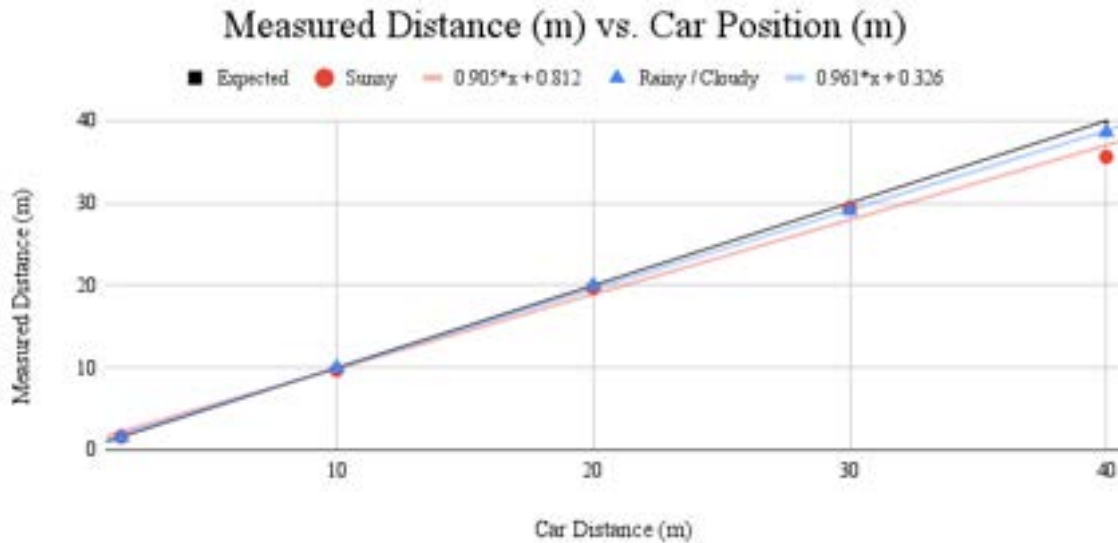

Figure 18. Measured Distance vs. Car Position for Sensor Validation

The data from both experiments show that the sensor provides measurements which have both a consistent and nearly linear trend and a low amount of absolute error.

Finally, we placed the car closer than 1.5 meters away from the sensor to observe the behavior of the sensor when the target object falls within the bounds of the distance filter. When observing objects closer than 1.5 meters, the distance measuring fluctuated greatly between near (2-5m) and far (20-30m) distances. To counteract the erratic measurements, we implemented a moving average filter to prevent the display from notifying the rider based on invalid data. The design and verification of the moving average filter is described in the intuitive notification metric test plan.

## Speed Sensing

Testing for speed sensing uses the same physical setting and instrumentation as distance testing. Measurements are taken by placing the target car 60m away from the observation car. Phone communication is maintained between the driver of the target car and the team member in the observation car to inform the observer when the target car reaches its target velocity. This allows the observer to record the sensor reading for a known car velocity. Measurements are taken at 10, 14, 20, 24, and 25 miles per hour. Given that the distance measurements were accurate and consistent between weather conditions (as described in distance sensing testing) and the notification algorithm is based only on car distance (as described in the intuitive notification test plan), the experiment was only conducted in rainy/cloudy weather.

The speed sensing showed a linear relationship between the car speed and measured speed, with the caveat that the car speedometer consistently read around 3.5 mph faster than the measurement from the sensor. The full results can be found in **Error! Reference source not found.** in

Appendix and are summarized in Figure 19:

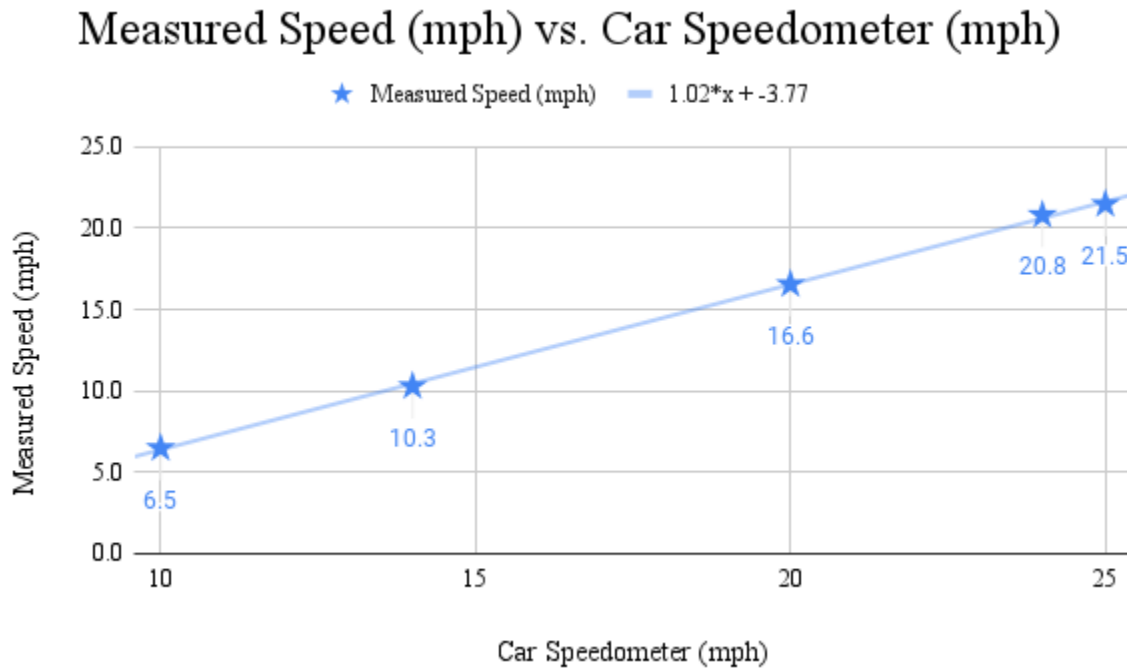

Figure 19. Measured Speed vs. Car Speedometer for Sensor Validation

The offset between the measured speed and car speedometer does not pose an issue for the performance of our sensor as a constant offset between speedometer and actual speed is not an unusual characteristic of European cars [53]. The target car was a 2004 BWM s5 which, as a European car, can be reasonably expected to have that performance. Furthermore, as long as the offset is consistent it can be adjusted for in software.

## Intuitive Notification

### Notification Algorithm Design Validation

The notification system for our product was designed explicitly because of end-user feedback to determine what type of notification would be considered intuitive. To determine the appropriate algorithm for notification of approaching cars we began by first identifying what a possible signal might look like. We determined that a reasonable initial notification algorithm would flash slowly if the detection of the approaching vehicle was not urgent, and flash quickly if the presence of approaching vehicle was urgent. Rather than deciding a-priori what kind of sensor data corresponds to an “urgent” signal, we elected to conduct a survey of frequent cyclists to determine how they would intuitively interpret a light display with a changing flash frequency.

The survey contained two videos of a lightbulb with a changing flash frequency wherein one video captured an increase in flash frequency and the other captured a decrease in flash frequency. For each video, participants were first asked to identify if and how the signal was changing in urgency and then asked to describe the motion of the car described by the notification signal. After asking participants to describe the signal we asked a series of demographic questions to provide context to our responses if we obtained inconsistent results. A full copy of the survey is included in

Appendix .

The results of the survey showed that most respondents could identify that the signal was changing urgency, as shown in Figure 20:

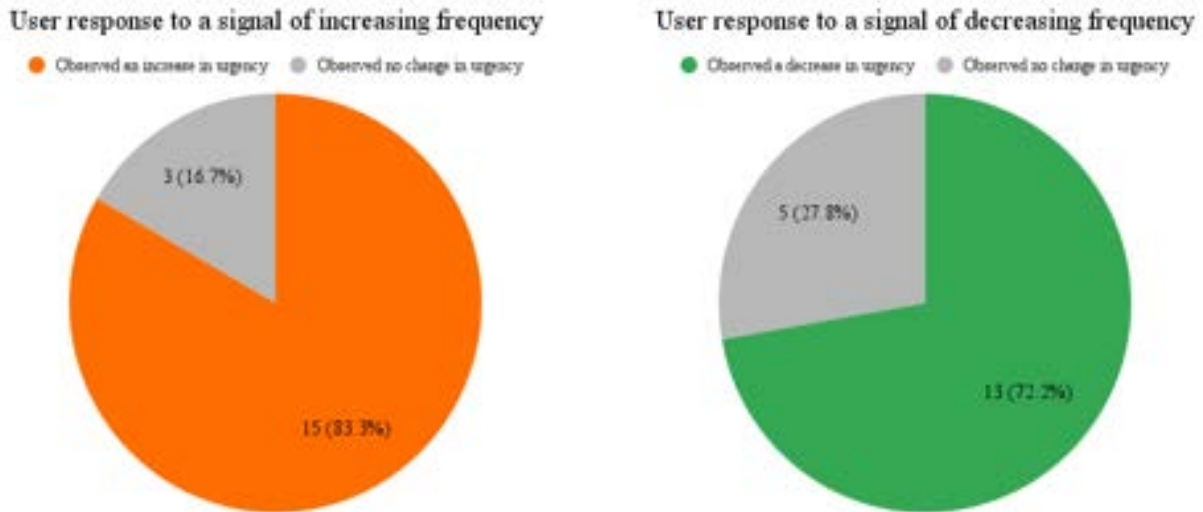

Figure 20. Responses from 18 target users asked to identify if a signal was changing urgency

While fewer respondents could identify when the signal was getting less urgent, it is preferable that the users err on the side of seeing notifications as urgent as it is better to avoid a collision that might happen than to fail to avoid a collision that does. Additionally, all target users that responded that the signals were changing in urgency associated the change in urgency with a change in distance with only a few associating the change in urgency with a change in speed as well as distance. The breakdown of these responses can be found in

## Appendix .

Following the completion of the survey, we determined that the most intuitive algorithm for our system would be one that maps the distance of approaching objects to the period of the light bulb flashes. The resulting notification displays a slow flash frequency when cars are far away from the device and a fast flash frequency when they care close to the device.

When performing field testing, it was found that under 1.5m range readings, the sensor would read sporadic unexpected range readings. A moving average of range readings was implemented to ignore any readings that were drastically unlike recent samples. (A moving average keeps track of the average change in data over time). If the moving average was less than 0.2, It means that the data being read was relatively stable and was not counting any extraneous sporadic data. By pointing the sensor at a stationary wall, it was experimentally determined that readings with a moving average of under 0.2 m filtered out any unexpected jumps in data since the LEDs would always blink at the fastest frequency when an object was within 1.5 meters.

### **Notification Algorithm Performance Verification**

#### *Testing UART Communication*

Prior to creating the intuitive notification display, the group needed to first verify that data was being properly read into the MSP430 via the UART protocol. This test was done by first connecting the Tx pin of the radar sensor to the Rx pin (3.4) of the MSP430. Once this was done, the radar sensor was connected to a 5V power supply. It is important to mention that for this test, the radar sensor cannot be connected via USB. Once a USB connection is made from the sensor to another device, the communication protocol switches and UART is ignored. Therefore, the battery supply was used to power both the radar sensor and MSP430 for the purposes of the two sharing a common ground. The group found the signals to be a bit noisy when reading the oscilloscope when the MSP430 was powered by the computer.

In order to verify, the code needed to be reconfigured such that when an interrupt was triggered by the Rx data buffer being filled, the data was placed into the Tx buffer rather than being placed into the buffer for parsing. Once this is done, an oscilloscope can be placed on both the Tx pins on the sensor and MSP430 (pin 3.3). The results of this test can be seen on Figure 21 where two separate square waves should appear. These square waves represent the bits of information being sent from the sensor to the MSP430. When looking at these waveforms, the waveform reading the Tx pin of the MSP430 should lag slightly behind that of the radar sensor. This is because there is a delay between the MSP430 receiving the data and waiting for the Tx buffer to be free.

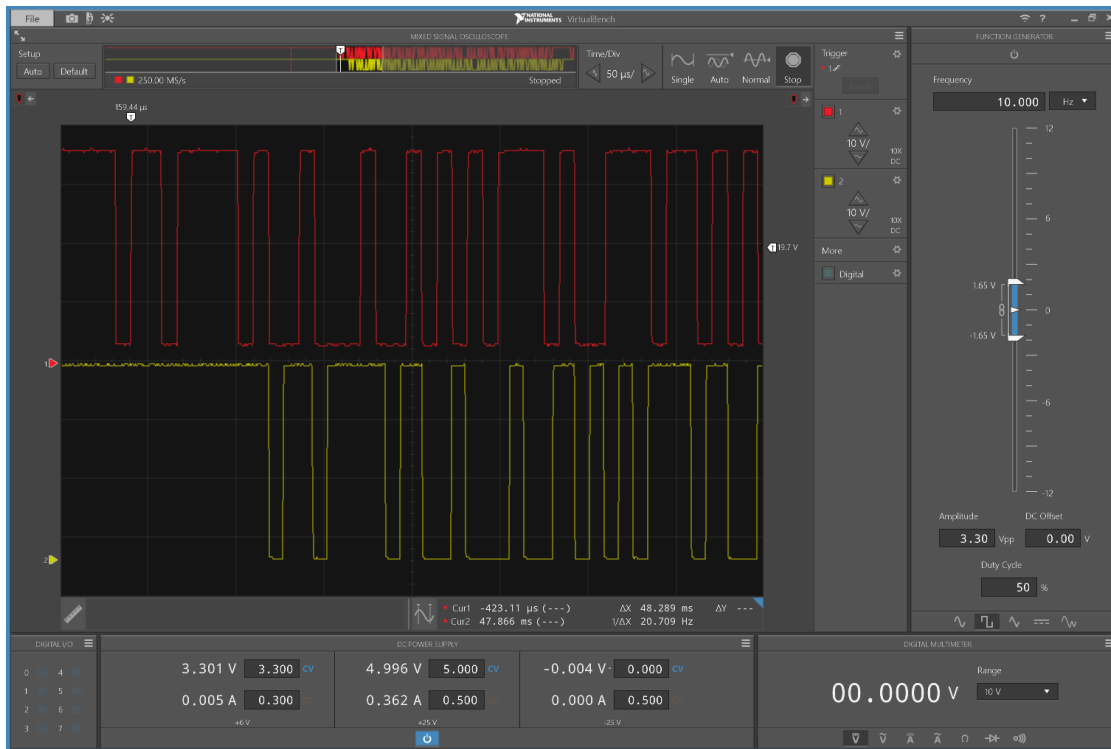

Figure 21. UART verification displaying data transfer

After verifying that the UART connection between the radar sensor and the MSP430 is made, testing that the data is properly placed in the translation buffer needs to be done. This test is done by connecting the Tx pin of the sensor to the Rx pin of the MSP430. The ISR of the Rx pin on the MSP430 is also adjusted to copy the given data into a buffer. Lastly, the MSP430 should be connected to the user's laptop running CCS to use the expressions window. After the system is configured, code execution can begin, and the user can look at the translation buffer. When looking at this buffer, the user should be able to see JSON data where each index in the buffer corresponds to a respective character in the JSON string.

### Testing the JSON Parser

The `jsmn.h` header file JSON library parser was used to parse the incoming JSON data from the Rx data buffer. The Rx data buffer is a pointer to a JSON string with the following key value pairs:

```
“{“unit”: “m”, “range”: range_reading_as_a_float}”
```

The sensor was held from the wall at varying distances and the float value from the range reading was compared to the in-life distance. The JSON parser was overall able to properly extract a float reading from the JSON string.



The frequency at which the UART buffer data is read is controlled by a periodic timer, TIMER\_B0. TIMER\_B0 is configured to run at a 20 Hz frequency. Figure 22 shows the LED being turned on and off for port pin 2.4 with a 20 Hz frequency, confirming the interrupt's timing.

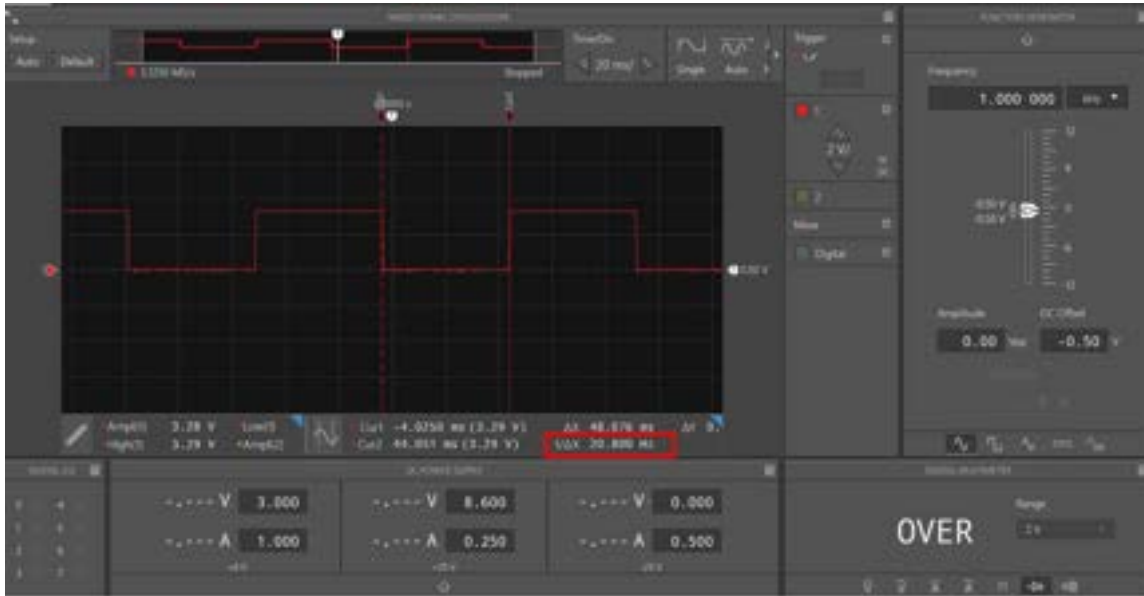

Figure 22. TIMER\_B0 interrupt PWM signal with a 20 Hz Frequency

## Weatherproof Testing

NEMA3 standards [21] requires the Sentinel to be resistant to mist and rain. A paper towel was placed in each of the 3D encapsulations. Once these enclosures were properly sealed, each of them was placed under a sink faucet for a 30 second duration. After this period ended, the enclosures were opened, and the paper towel was removed. Each of the paper towels taken from the 3D printed models came out completely dry. Photos from this testing can be found in Appendix Test Plan.

## Electrical Component Testing

### Verifying MPPT Functionality

The MPPT functionality of the assembled board needed to be verified. To test this, a fluorescent bulb was placed at a fixed distance from the solar panel and run into the MPPT. Originally, the circuit was not functioning effectively and significant amount of current was being dissipated in the MPPT circuit. However, by switching to a catch diode with a lower forward voltage, the efficiency was improved significantly. Ultimately, the MPPT tracker was able to operate at an efficiency of nearly 90%.

### Verifying Voltage Regulator Functionality.

Both the 5V switching regulator and 3.3V linear regulator needed to be verified. The linear regulator functioned perfectly out of the box, as it was a very simple integrated circuit effectively only containing two passive components. However, the 5V switching regulator was unstable with low input voltage at startup with low load. This was improved by adding additional bulk capacitance to the input and output of the regulator, as well as a small bias load.

## Final Results

### Summary of Success Metrics

Each of the deliverables outlined in the objective tree (Figure 1) corresponds to a metric by which the success of this project is evaluated. Table III provides a summary of the project success metrics and their corresponding point values.

*Table III. Summary of Project Success Metrics*

	<b>0</b>	<b>1</b>	<b>2</b>	<b>3</b>	<b>4</b>	<b>5</b>
<b>Distance Sensing</b>	Cannot detect any objects	Can detect the presence of an object up to 5m away	Can detect the presence of an object up to 10m away	Can detect the presence of an object up to 20m away	Can detect the presence of an object up to 30m away	Can detect the presence of an object up to 40m away
<b>Relative Speed Sensing</b>	Cannot detect when a car is approaching too fast	Can very rarely detect when a car is approaching too fast	Occasionally can detect when a car is approaching too fast	Can sometimes detect when a car is approaching too fast	Can detect when a car is approaching too fast most of the time	Can detect if a car is approaching too fast
<b>Intuitive Notification</b>	Does not alert based on sensor data	Very rarely alerts based on sensor data	Occasionally alerts based on sensor data	Sometimes alerts based on sensor data	Mostly alerts based on sensor data	Always alerts based on sensor data
<b>Backup Power Storage</b>	No backup power storage	Backup power for up to 30 minutes of use	Backup power for up to 1 hour of use	Backup power for up to 1 hour & 30 minutes of use	Backup power for up to 2 hours of use	Backup power storage giving 2 or more hours of use
<b>Native* Power Generation</b>	No native power generation	Power generation for up to 15 minutes of use	Power generation for up to 30 minutes of use	Power generation for up to 45 minutes of use	Power generation for up to 1 hour of use	Native power generation for 1 or more hours of use
<b>Weatherproof</b>	Is not waterproof		Can withstand low levels of water (mist)			Can withstand rain

<b>Sensing in all weather conditions</b>	Does not work in any weather conditions	Works in sunny weather conditions	Works in partially cloudy weather conditions	Works in cloudy weather conditions	Works in rainy weather conditions	Can provide full capability in a variety of weather conditions
--	---	-----------------------------------	--	------------------------------------	-----------------------------------	--

\*Native power generation requirements define how long the system can run off one full day of solar charging.

After a point value is assigned to the implementation of each objective based on the metric table, the points are totaled to determine the final score of the project. The conversion from point values to letter grade as written in our initial proposal can be found in Table IV.

*Table IV. Conversion from point value to letter grade*

Points	Grade
32	A
27	B
21	C
17	D

## **Fulfillment of Objectives**

### **Distance Sensing**

Based on the results of our sensor testing, we have fulfilled the metric item “can detect the presence of an object up to 40m away.” While the sensor never reported a reading of 40m or greater, it did detect the presence of the car when it was 40m away meaning that it would still trigger the display from a physical distance of 40m. As the exact sensor measurement is abstracted in encoding distance data as a flash frequency, it is sufficient for our purposes to simply detect the presence of a car 40m away. Furthermore, the accuracy of the distance sensing is better as the sensor is closer to the detected object where accuracy is more important. Finally, as our notification algorithm is relative, the exact values of the distance are abstracted away when converting car distance to display flash frequency. Therefore, the resulting score for this metric as defined in the rubric is 5 points.

### **Relative Speed Sensing**

From the results seen in the speed sensing section of the report, the conclusion can be reached that our product is able to properly detect the relative speed of the oncoming vehicle. From the graph seen in Figure 19, the speed that the sensor is reading is off by a constant offset of about 3.7MPH. However, as previously explained, a constant offset is both not unexpected nor is it problematic or the system. Therefore, we can justify that our device can properly detect if a vehicle is approaching too fast.

## **Intuitive Notification**

Based on the results of our sensor testing, we have fulfilled the metric item “always alerts based on sensor data.” Our notification algorithm was developed through user-focused design validation and tested sufficiently to show that the firmware correctly obtained readings from the sensor and actuated the LED display based on those data. The functionality of the LEDs switching frequency based on object distance is best seen in the demo video, submitted for consideration alongside this paper.

## **Backup Power Storage**

The capacity of our battery pack is 13.32Wh. This number is still achieved even by conservatively limiting the battery state of charge to between 20% and 80% to improve lifetime. The power consumption of the system was measured at 2.3W with the display illuminated, which represents a worst-case consumption. A capacity of 13.32Wh can supply 2.3W for about 5.8 hours, which is more than sufficient to fulfill our metric of 2 or more hours of power storage.

## **Native Power Generation**

A power budget analysis estimated a worst-case power consumption of 2.294W, and characterization of the real system showed a true power consumption of 2.3W. System tests also revealed a 4.3W peak power production under realistic conditions. From a power budget analysis, we have determined that the system can generate 2.35Wh of energy from our solar system on a worst-case day, which will be sufficient to power the system for 1.02 hours. Given our power generation capability of about 4.3W and peak power consumption of 2.3W, this hour of battery life can be recovered easily within one hour of charging even in less-than-ideal conditions.

## **Weatherproof**

To create a robust and durable system, the Sentinel needs to be resistant to multiple weather conditions. The results of our paper towel waterproof testing showed that our boxes could withstand heavy amounts of moisture. Therefore, we have determined that our product is able to withstand rain providing the group with a score of 5 in this category.

## **Sensing in all Weather Conditions**

Given that the results of our distance testing showed consistency between rain and overcast weather within one single experiment as well as consistency between rain/clouds between two experiments, we have determined that our system can accurately sense cars in cloudy, sunny, and rainy weather conditions. Based on our metrics, the ability to accurately sense cars in a variety of weather conditions awards us with a score of 5 for this metric.



## Final Grade

Following testing of all our metrics, we have received the highest possible score in each objective category. This results in a final score of 35 for the completion of our project.

*Table V. Summary of objective categories and points awarded totaling 35 points*

Metric	Qualification	Points Awarded
<b>Distance Sensing</b>	Can detect the presence of an object up to 40m away	5
<b>Relative Speed Sensing</b>	Can detect if a car is approaching too fast	5
<b>Intuitive Notification</b>	Always alerts based on sensor data	5
<b>Backup Power Storage</b>	Backup power storage giving 2 or more hours of use	5
<b>Native* Power Generation</b>	Native power generation for 1 or more hours of use	5
<b>Weatherproof</b>	Can withstand rain	5
<b>Sensing in all weather conditions</b>	Can provide full capability in a variety of weather conditions	5

According to the point value to letter grade conversion in Table IV, our project meets the highest point value possible in the “A” range.

## Costs

Table VI outlines the final total cost of the project at 585.57 dollars. Sentinel went over budget, mostly due to the cost of the radar sensor (\$229). Furthermore, many components were bought for time-efficiency instead of being 3D printed, such as the bike mounts. Sentinel's cost in the future could be drastically reduced if the RF layout and power PCB were manufactured on the same chip.

*Table VI. Final Total Cost of Sentinel*

<b>Solar</b>	<b>Component</b>	<b>Quantity</b>	<b>Cost per Line Item (\$)</b>
	Solar Array	1	40
	Battery	1	10
<b>Sensors</b>			
	OPS243-C-FC-RP	1	229
<b>LED Display</b>			
	LED	1	5
	Misc. Wire Connection	-	15
<b>3D Printing</b>			
	Filament	-	50
	Plexiglass	2	23
	Handlebar Mount	1	18.93
	Waterproof wire connectors	5	15
<b>MCUs</b>			
	MSP430G2744IDA38	1	0
<b>PCBs</b>			
	2 boards, 2 send outs	2	66
<b>Power Components</b>			
	Order 1	1	45.86
	Order 2	1	36.98
	Order 3	1	15.91
	Order 4	1	45.05

## Future Work

The main improvements to be made to the system are centralized on the idea of extending the display system that was described in this paper. Limiting the product to just using LEDs for notifying the cyclist leads to difficulties in describing more extensive information than immediate danger. For example, our current product can distinguish that there is an object approaching and intuitively notify the rider based on this information. However, if there are multiple vehicles in the vicinity, then there is no mode to notify the user of this case. Furthermore, despite the location of the vehicle in the field of view of the sensor, the display will give the same indication and not provide any indication of direction. While our product properly alerts cyclists of oncoming vehicles, the states could be extended to provide more useful information.

Furthermore, more of the computational power of the microcontroller could be utilized by connecting our product to the internet of things (IoT). By connecting this product to the IoT, data could constantly be tracked and analyzed to provide cyclists with more information about the routes they take for their routes. For example, by tracking the number of cars detected on a cyclist's commute, we could offer alternative routes that are known to have a fewer number of vehicles during that time of day.

There are also many improvements that could be made to the power system. One such improvement would be to add a passthrough circuit to the MPPT such that the solar panel could supply the power regulators instead of the power when sunlight was present. This could increase the overall efficiency of the system. Additionally, the switching frequency and component selection in the 5V regulator could be further optimized to increase efficiency. Both improvements would reduce power consumption and increase battery life. Finally, the radar sensor could be optimized for power consumption. Because it represents the primary power consumption in the circuit, this could reduce solar panel area size and required battery capacity, reducing both size and weight.



## References

- [1] Peña, E., Legaspi, M., "UART: A Hardware Communication Protocol Understanding Universal Asynchronous Receiver/Transmitter," Analog Devices, [Online]. Available: <https://www.analog.com/en/analog-dialogue/articles/uart-a-hardware-communication-protocol.html>. [Accessed 16 December 2021].
- [2] Insurance Institute for Highway Safety, "Fatality Facts 2019: Bicyclists," March 2021. [Online]. Available: <https://www.iihs.org/topics/fatality-statistics/detail/bicyclists>. [Accessed 10 September 2021].
- [3] "Healthy but risky: A descriptive study on cyclists' encouraging and discouraging factors for using bicycles, habits and safety outcomes," *Psychology and Behaviour*, vol. 62, no. 1, pp. 587-598, 2019.
- [4] K. McLeod, "New: Census Data on Bike Commuting," 8 May 2014. [Online]. Available: <https://bikeleague.org/content/new-census-data-bike-commuting>. [Accessed 10 September 2021].
- [5] Texas Instruments, "MSP430F552x, MSP430F551x Mixed-Signal Microcontrollers," MSP430F5529 datasheet, Sept. 2020. [Online]. Available: <https://www.ti.com/lit/ds/symlink/msp430f5528.pdf?ts=1639528108227>.
- [6] OmniPreSense, "OPS243 Short Range Radar Sensor," OPS243 Datasheet, 28 Mar. 2019. [Online]. Available: [https://www.mouser.com/pdfDocs/OPS-DS-003-01\\_OPS243-Datasheet.pdf](https://www.mouser.com/pdfDocs/OPS-DS-003-01_OPS243-Datasheet.pdf). [Accessed 2021 Dec. 2021].
- [7] Renology, "10W Monocrystalene Solar Panel," RNG-10D-SS, [Online]. Available: <https://images.homedepot-static.com/catalog/pdfImages/b5/b5fcb888-d5c6-4fd1-8d67-5c2ddeb84f9f.pdf>. [Accessed 14 December 2021].
- [8] Great Power, "ICR18650 2600mAH Datasheet," DOC No: GP-ER-A-0001, 18 Jul. 2018. [Online]. Available: <https://cdn.sparkfun.com/datasheets/Prototyping/ICR18650%202600mAH%20datasheet.pdf>.
- [9] Texas Instruments, "Monolithic Non-Synchronous Step-Down Regulator With Integrated MOSFET datasheet (Rev. B)," TPS5405, Apr. 2013. [Online]. Available: <https://www.ti.com/general/docs/suppproductinfo.tsp?distId=10&gotoUrl=https%3A%2F%2Fwww.ti.com%2Flit%2Fgpn%2Ftps5405>. [Accessed 15 December 2021].

- [10] A. Devices, "Low Quiescent Current CMOS Linear Regulator," ADP121, 2012. [Online]. Available: [https://datasheet.lcsc.com/szlcsc/Analog-Devices-ADI-ADP121-AUJZ33R7\\_C50499.pdf](https://datasheet.lcsc.com/szlcsc/Analog-Devices-ADI-ADP121-AUJZ33R7_C50499.pdf). [Accessed 15 December 2021].
- [11] *High Low Temperature Cable M1224*, Alpha Wire, 2021.
- [12] C. Elliott, "Are Vehicle Safety Features Actually Reducing Car Accidents?," Forbes Advisor, 16 July 2020. [Online]. Available: <https://www.forbes.com/advisor/car-insurance/vehicle-safety-features-accidents/>. [Accessed 20 September 2021].
- [13] R. Jeon, "Roadway Safety Institute," April 2018. [Online]. Available: <http://cts-d8resmod-prd.oit.umn.edu:8080/pdf/cts-18-06.pdf>. [Accessed 15 September 2021].
- [14] Garmin, "Garmin Varia™ RTL515 | Bike Radar and Tail Light," [Online]. Available: <https://buy.Garmin.com/en-US/US/p/698001>. [Accessed 10 September 2021].
- [15] Rosenthal Law Firm, "California Mirror Laws," 15 July 2020. [Online]. Available: <https://www.rosenthalinjurylaw.com/california-mirror-laws/>. [Accessed 19 September 2021].
- [16] PuTTY, "Download PuTTY: release 0.76," PuTTY, 17 July 2021. [Online]. Available: <https://www.chiark.greenend.org.uk/~sgtatham/putty/releases/0.76.html>. [Accessed 14 December 2021].
- [17] OmniPreSense Corporation, "API Interface Specification," AN-010, 30 Sept. 2019. [Online]. Available: [https://omnipresense.com/wp-content/uploads/2019/10/AN-010-Q\\_API\\_Interface.pdf](https://omnipresense.com/wp-content/uploads/2019/10/AN-010-Q_API_Interface.pdf). [Accessed 15 December 2021].
- [18] Creality, "Ender 3D Pro High Precision 3D Printer," [Online]. Available: <https://creality3d.shop/collections/3d-printer/products/creality3d-ender-3-pro-high-precision-3d-printer>. [Accessed 12 December 2021].
- [19] Heyco, "Heyco® Original Series-35 Liquid Tight Cordgrip," Heyco, 2021.
- [20] *Mountain Bike Phone Mount*, Amazon, 2021.
- [21] NEMA Enclosures, "NEMA Ratings for Enclosures," 2020. [Online]. Available: <https://www.nemaenclosures.com/enclosure-ratings/nema-rated-enclosures.html>. [Accessed 15 December 2021].
- [22] IPC: Association Connecting Electronics Industries, "Generic Standards on Printed Board Design," May 2003. [Online]. Available: <https://www.ipc.org/TOC/IPC-2221A.pdf>. [Accessed 15 December 2021].

- [23] IPC: Association Connecting Electronics Industries, "Acceptability of printed boards," Nov. 1999. [Online]. Available: <https://www.ipc.org/TOC/IPC-A-600J.pdf>. [Accessed 15 December 2021].
- [24] National Instruments, "Virtualbench," [Online]. Available: <https://www.ni.com/enus/shop/hardware/products/virtualbench-all-in-one-instrument.html>. [Accessed 12 December 2021].
- [25] Universal Laser Systems, "PLS6.150D Laser Cutter," [Online]. Available: <https://www.ulsinc.com/products/platforms/pls6-150d>. [Accessed 15 December 2021].
- [26] Texas Instruments, "Code Composer Studio™ integrated development environment (IDE)," ver. 10.4.0, 8 Jul. 2021. [Online]. Available: [https://software-dl.ti.com/ccs/esd/documents/ccs\\_downloads.html](https://software-dl.ti.com/ccs/esd/documents/ccs_downloads.html). [Accessed 15 December 2021].
- [27] Kicad, "KiCad EDA," ver. 5.1.10, November 2021. [Online]. Available: <https://www.kicad.org/download/>. [Accessed 15 December 2021].
- [28] Dassault Systemes SolidWorks Corporation, "Solidworks," 2021. [Online]. Available: [https://my.solidworks.com/try-solidworks?mktid=13829&utm\\_campaign=202007\\_nam\\_sw\\_GoogleSWOPT\\_en\\_XOP2050\\_rise\\_brand\\_us\\_exact&utm\\_medium=cpc&utm\\_source=google&utm\\_content=search&utm\\_term=Cj0KCQIA5OuNBhCRARIsACgaiqUapj8XWTXI8SIIC4tB9GFxrLXI\\_jVnvvapd6PSSX584Us](https://my.solidworks.com/try-solidworks?mktid=13829&utm_campaign=202007_nam_sw_GoogleSWOPT_en_XOP2050_rise_brand_us_exact&utm_medium=cpc&utm_source=google&utm_content=search&utm_term=Cj0KCQIA5OuNBhCRARIsACgaiqUapj8XWTXI8SIIC4tB9GFxrLXI_jVnvvapd6PSSX584Us). [Accessed 15 December 2021].
- [29] Cura, "Ultimaker," ver. 4.12.1, [Online]. Available: <https://ultimaker.com/software/ultimaker-cura>. [Accessed 15 December 2021].
- [30] Rabaia, M., Abdelkareem, M., Sayed, E., Elsaid, K., Chae, K., Wilberforce, T., Olabi, A., "Environmental impacts of solar energy systems: A review," *Science of The Total Environment*, vol. 754, p. 141989, Feb. 2021.
- [31] D. Mulvaney, "Solar Energy Isn't Always as Green as You Think," *IEEE Spectrum*, 13 November 2014. [Online]. Available: <https://spectrum.ieee.org/solar-energy-isnt-always-as-green-as-you-think>. [Accessed 15 December 2021].
- [32] Dos Reis Benatto, G., Espinosa, N., Krebs, F., "Life-Cycle Assesment of Solar Charger with Integrated Organic Photovoltaics," *Advances Engineering Materials*, vol. 19, no. 8, 2017.

- [33] ENF Ltd., "Solar Recycling Companies," ENF Solar, 2021. [Online]. Available: <https://www.enfsolar.com/directory/service/manufacturers-recycling> . [Accessed 15 December 2021].
- [34] United States Environmental Protection Agency, "End-of-Life Solar Panels: Regulations and Management," [Online]. Available: <https://www.epa.gov/hw/end-life-solar-panels-regulations-and-management> . [Accessed 15 December 2021].
- [35] C. W. J. McAlister, "The potential of 3D printing to reduce the environmental impacts of production," 2014. [Online]. Available: [https://www.eceee.org/library/conference\\_proceedings/eceee\\_Industrial\\_Summer\\_Study/2014/2-sustainable-production-design-and-supply-chain-initiatives/the-potential-of-3d-printing-to-reduce-the-environmental-impacts-of-production/](https://www.eceee.org/library/conference_proceedings/eceee_Industrial_Summer_Study/2014/2-sustainable-production-design-and-supply-chain-initiatives/the-potential-of-3d-printing-to-reduce-the-environmental-impacts-of-production/). [Accessed 15 December 2021].
- [36] P. L. Olson, "Driver Perception Response Time," in *SAE Technical Paper 890731*, 1989.
- [37] E. McPhillips, "World Wide Hearing Loss: Stats from Around the World," 11 October 2021. [Online]. Available: <https://www.audicus.com/world-wide-hearing-loss-stats-from-around-the-world/>. [Accessed 15 December 2021].
- [38] Garmin, "Important Safety and Product Information," Garmin Varia Product Information, Nov. 2021. [Online]. Available: [https://static.garmin.com/pumac/varia\\_ISPI.pdf](https://static.garmin.com/pumac/varia_ISPI.pdf). [Accessed 2021 December 2021].
- [39] E. Brismitzakis, R. Stirling, K. Carlson, F. Struwig and N. Heerden, "Camera augmented bicycle radar sensor system". United States of America Patent US10393872B2, 9 July 2019.
- [40] A. K. J. Gadil, "Obstacle avoidance system". United States of America Patent US10748435, 9 September 2016.
- [41] P. Irrgang, S. Kanzler and A. Schelensag, "Method and system for warning a driver of a vehicle about potential obstacles behind the vehicle". United States of America Patent US8952799B2, 10 February 2015.
- [42] *SimbaLux Acrylic Sheet Clear Cast Plexiglass*, Amazon, 2021.
- [43] Lowe's, "200-Piece Steel Zinc-Plated Combo Fastener Kit (Case Included)," Hillman, [Online]. Available: <https://www.lowes.com/pd/Hillman-200-Piece-Steel-Zinc-Plated-Combo-Fastener-Kit-Case-Included/3024351> . [Accessed 15 December 2021].
- [44] *Flex Tape*, Flex Seal, 2021.

- [45] *Glarks 1180 Pieces 2.54mm 2/3/4/5/6/7/8/9 Pin Housing Adapter Cable Connector Socket*, Amazon, 2021.
- [46] *OVERTURE PLA Filament*, Amazon, 2021.
- [47] Solidworks, *Solidworks Programs*, 2021: Solidworks.
- [48] K. Glue, *Products*, Krazy Glue, 2021.
- [49] *Black ZipTies*, Amazon, 2021.
- [50] *Schwinn Bike Rear Rack Bicycle Accessories*, Amazon, 2021.
- [51] *Glarks 1180 Pieces 2.54mm 2/3/4/5/6/7/8/9 Pin Housing Adapter Cable Connector Socket Male and Female with 2.54mm Female Pin Header Connector*, Amazon, 2021.
- [52] Zaitsev, S., "The most simple JSON parser in C for small systems.," [Online]. Available: <https://zerge.com/jsmn/>. [Accessed 17 December 2021].
- [53] Cammisa, J., "Don't Trust Your Car's Speedometer," Hearst Magazines, 8 June 2020. [Online]. Available: <https://www.roadandtrack.com/car-culture/car-accessories/a32026968/are-speedometers-accurate/>. [Accessed 17 December 2021].
- [54] Digilent, "Analog Discovery 2," [Online]. Available: . <https://digilent.com/shop/analog-discovery-2-100ms-s-usb-oscilloscope-logic-analyzer-and-variable-power-supply/>. [Accessed 12 December 2021].
- [55] "Glarks 1180 Pieces 2.54mm 2/3/4/5/6/7/8/9 Pin Housing Adapter Cable Connector Socket Male and Female with 2.54mm Female Pin Header Connector Perfectly Compatible with JST-XHP Connector Kit," Amazon, [Online]. Available: [https://www.amazon.com/gp/product/B07CTH46S7/ref=ppx\\_yo\\_dt\\_b\\_search\\_asin\\_title?ie=UTF8&th=1](https://www.amazon.com/gp/product/B07CTH46S7/ref=ppx_yo_dt_b_search_asin_title?ie=UTF8&th=1) . [Accessed 16 12 2021].
- [56] U. o. Virginia, "UVa School of Architecture Studio Labs," [Online]. Available: <https://www.arch.virginia.edu/about/studios-labs>. [Accessed 17 12 2021].

## Appendix A



*Figure 23. Handlebar mount for LED Display*

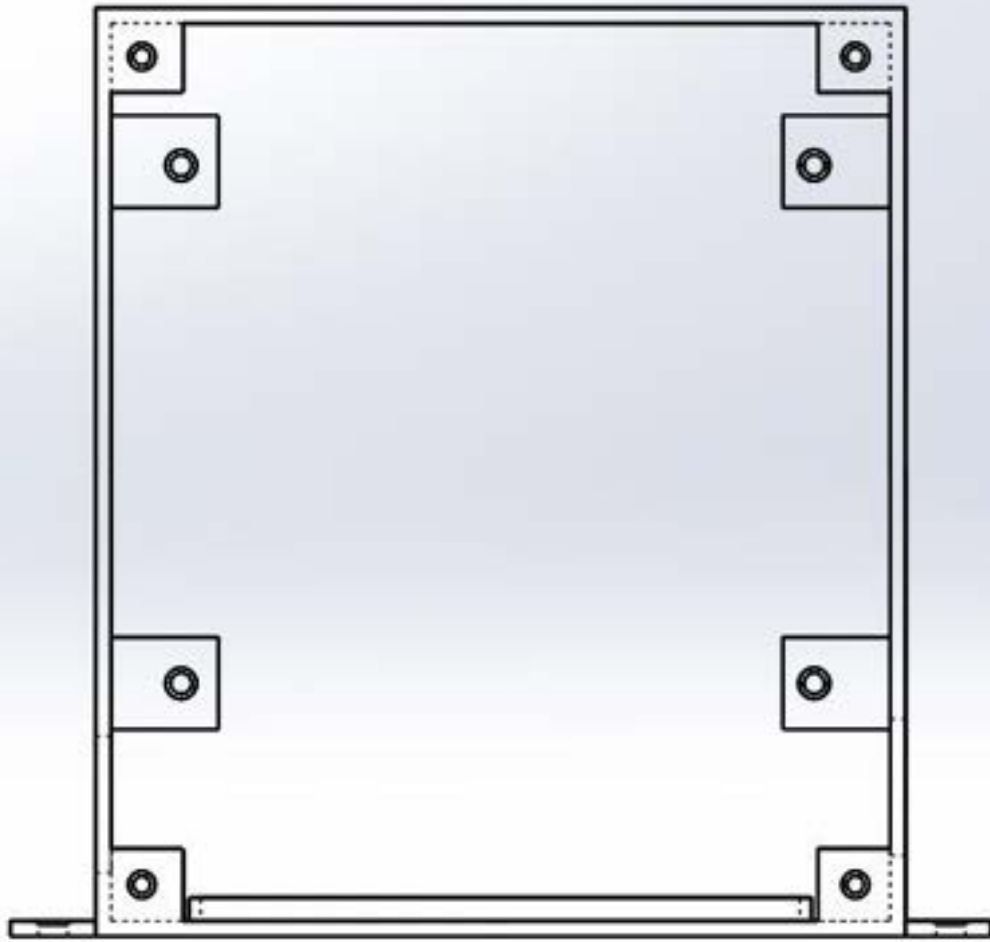

*Figure 24. Back View of Back Mount Printed box*

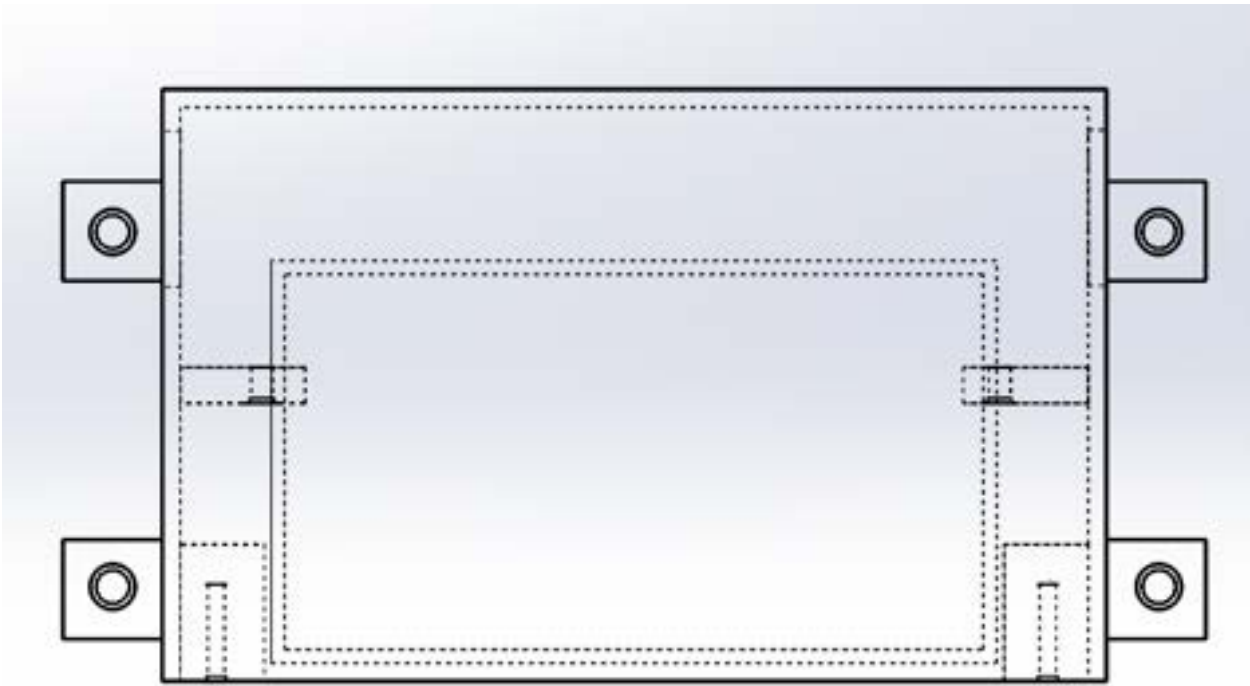

*Figure 25. Top View of Back box*

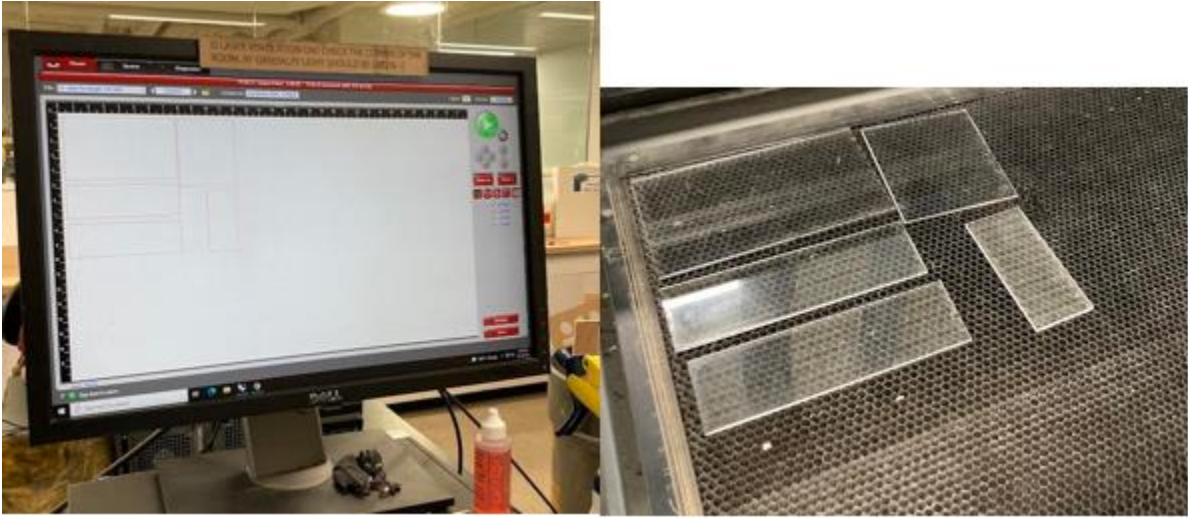



*Figure 26. Construction of Back Box*



*Figure 27. Securing of Bike Rack*



*Figure 28. Laser Cutting Process*

## Appendix B

### Sensor Testing Configuration

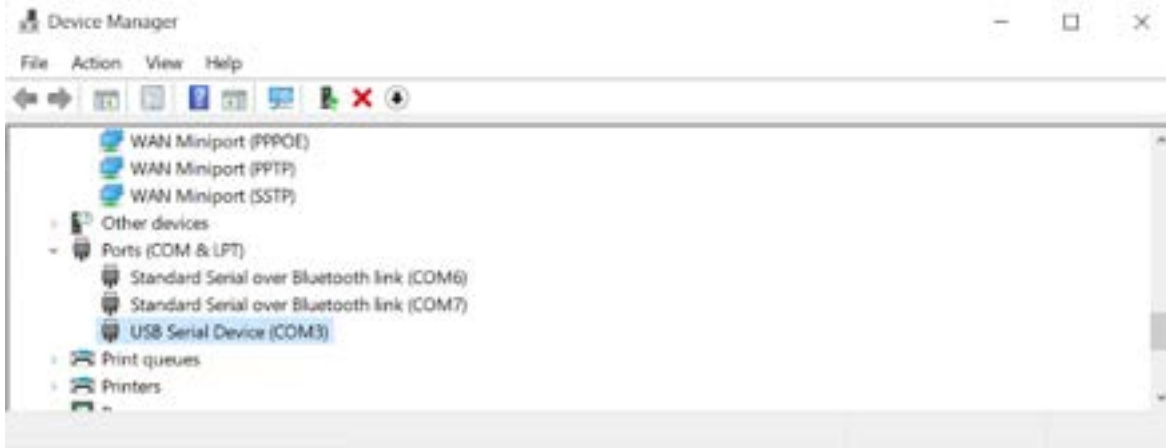

*Figure 29. Identification of the sensor in Windows Device Manager*

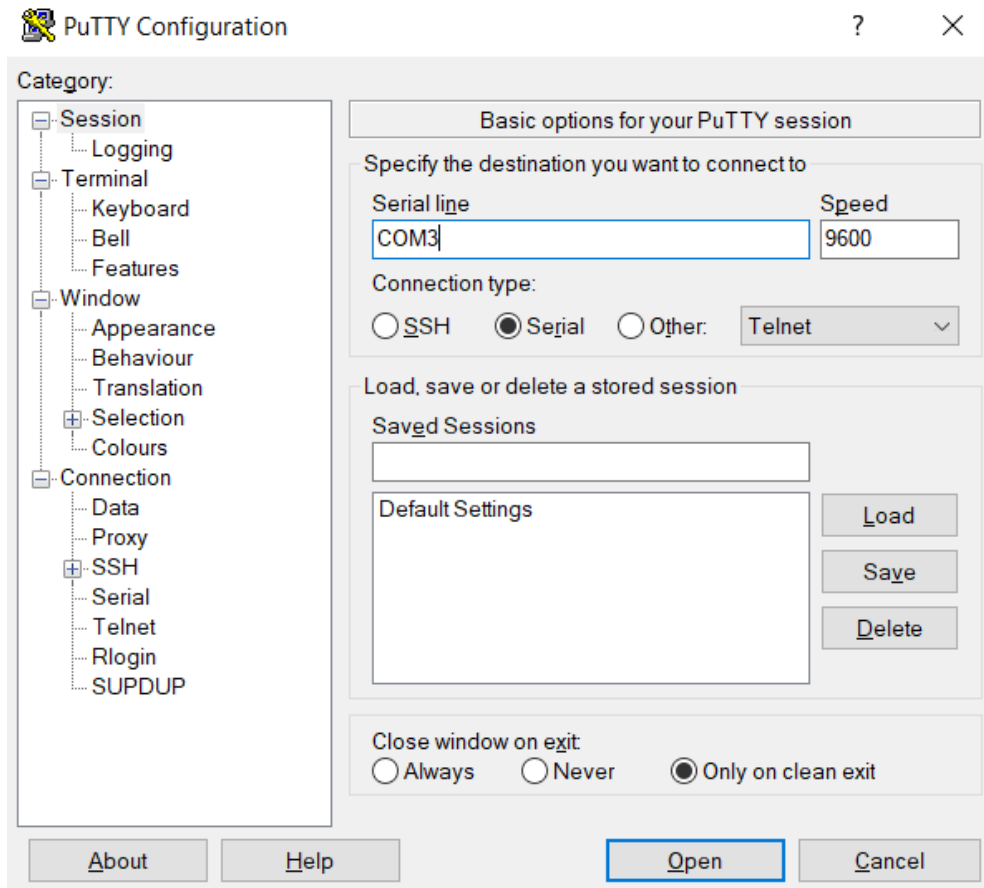

Figure 30. Default configuration to read OPS 243-C sensor data via PuTTY terminal

## Distance Sensing

*Table VII. Distance sensing verification data*

Car Position (m)	Measured Distance (m)		Absolute Error (m)		Percent Error (%)	
	Sunny	Rainy/Cloudy	Sunny	Rainy/Cloudy	Sunny	Rainy/Cloudy
1.5	1.6	1.6	0.1	0.1	6.7	6.7
10	9.7	10	0.3	0	3	0
20	19.7	20	0.3	0	1.5	0
30	26.4	29.1	0.6	0.9	2	3
40	25.6	38.6	4.4	1.4	11	3.5

## Speed Sensing

*Table VIII. Data for sensor speedometer verification*

Car Speedometer (mph)	Measured Speed (m/s)	Measured Speed (mph)	Difference (mph)
10	2.9	6.5	3.5
14	4.6	10.3	3.7
20	7.7	16.6	3.4
24	9.3	20.8	3.2
25	9.6	21.5	3.5

## Intuitive Notification

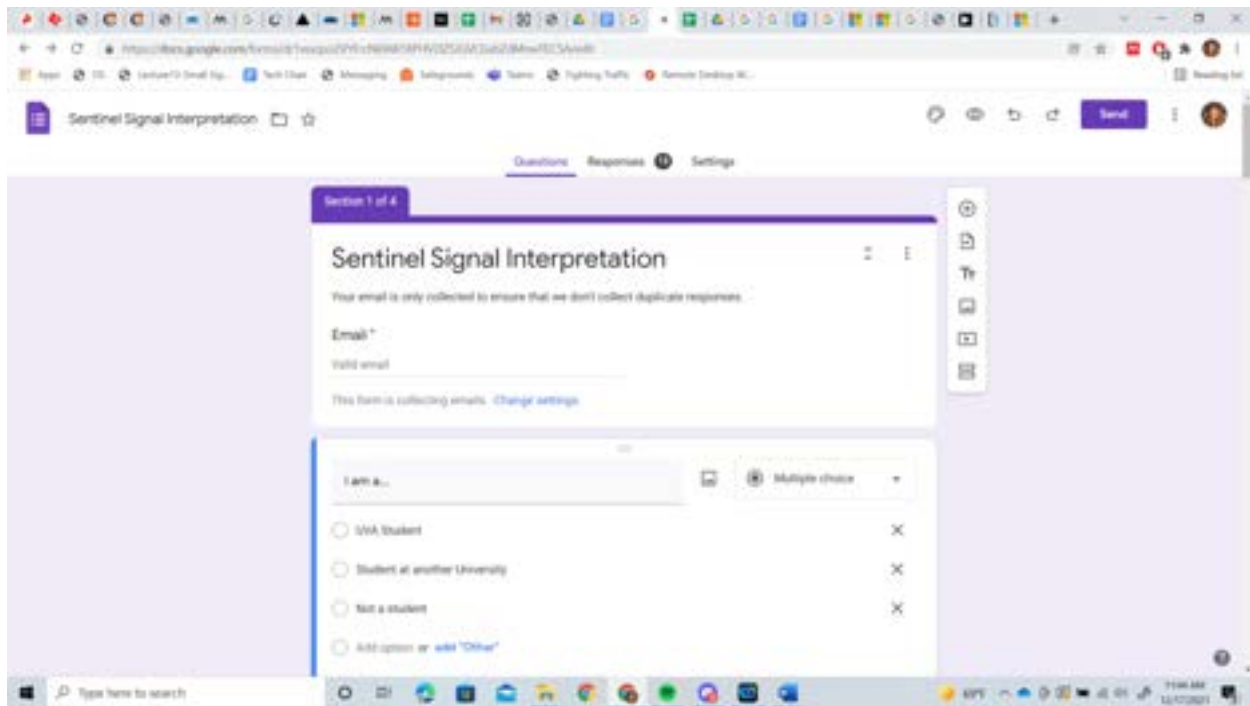

The image shows a web browser window displaying a Google Form titled "Sentinel Signal Interpretation". The form is part of a survey with four sections, and this is the first section. The form includes an email field with a note that the email is only collected to prevent duplicate responses. Below the email field is a question asking "I am a..." with a "Multiple choice" dropdown menu. The options are: "SMA student", "Student at another University", and "Not a student". There is also an option to "Add option or select 'Other'". The form is displayed on a light purple background with a white content area. The browser's address bar shows the URL: "https://docs.google.com/forms/d/eviewid/1wepo27Y1c7P88k18P1V12525AA/with/1E2/Survey". The Windows taskbar is visible at the bottom of the screen.

Section 1 of 4

### Sentinel Signal Interpretation

Your email is only collected to ensure that we don't collect duplicate responses.

Email\*

Valid email

This form is collecting emails. [Change settings](#)

I am a...

Multiple choice

- SMA student
- Student at another University
- Not a student
- [Add option or select "Other"](#)

Figure 31. Initial survey questions

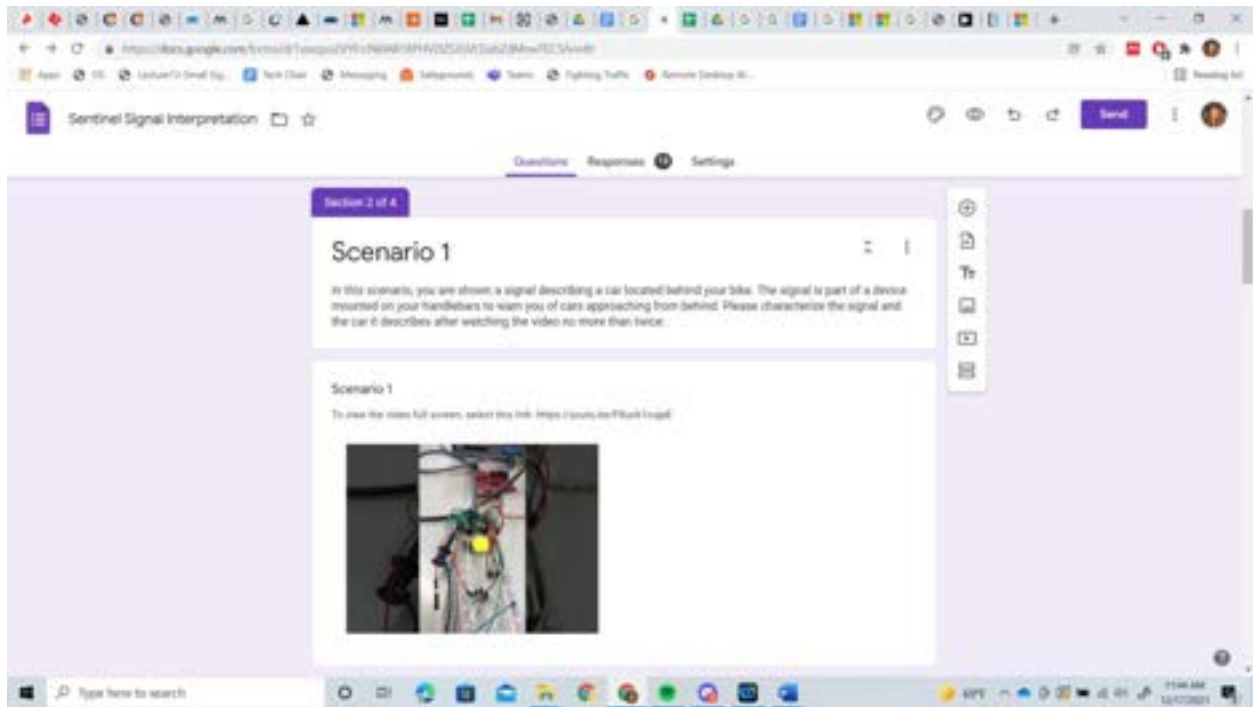

Figure 32. First scenario setup in survey



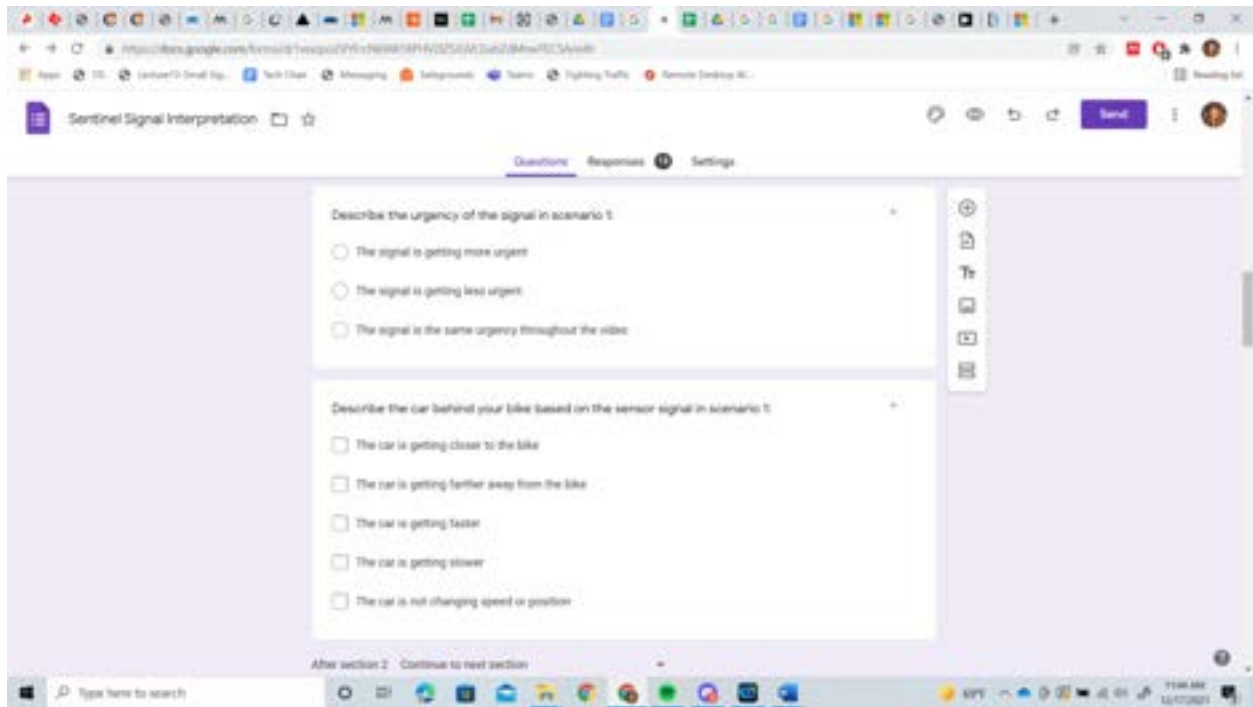

Figure 33. First scenario questions in survey

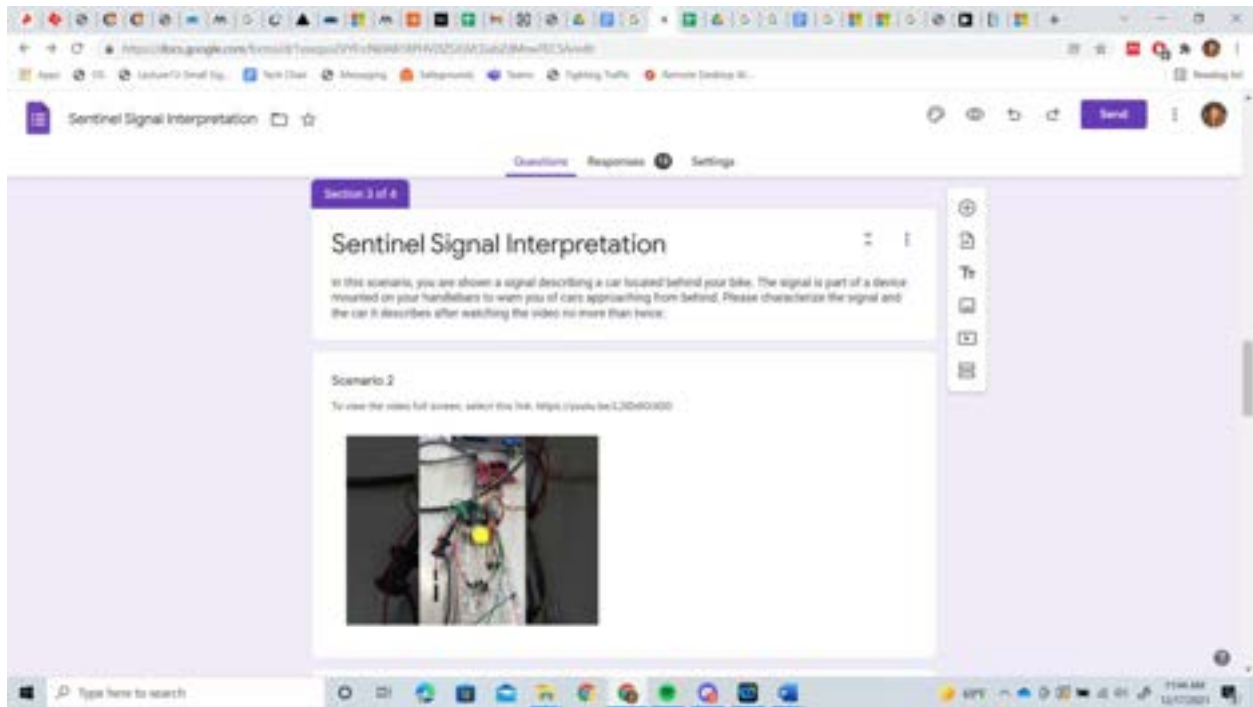

Figure 34. Second scenario setup in survey

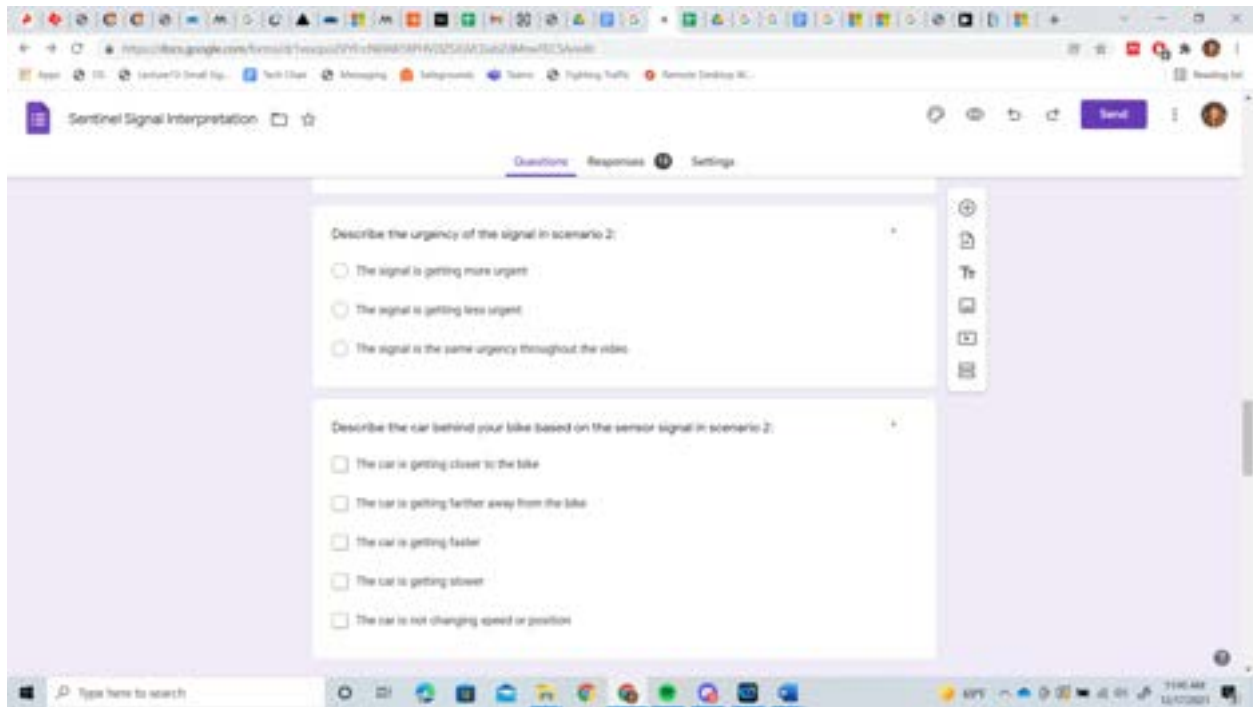
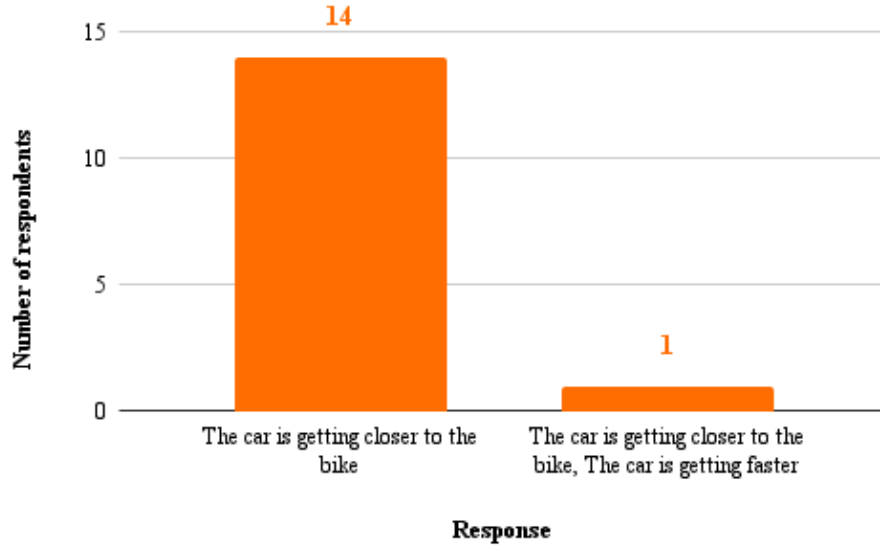

Figure 35. Second scenario questions in survey

**Characterization of car motion from users who determined the notification was getting more urgent**



*Figure 36. Characterization of car movement for a signal of increasing frequency/urgency*

### Characterization of car motion from users who determined the notification was getting less urgent

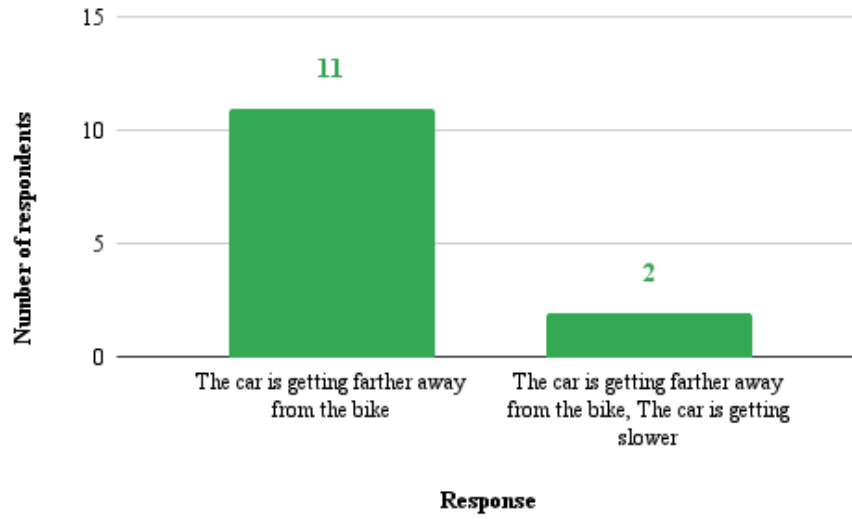

Figure 37. Characterization of car movement for a signal of decreasing frequency/urgency

## Waterproof Testing



*Figure 38. Back Box Waterproof Testing with Napkin*



*Figure 39. Front Box Waterproof Testing with Napkin*



*Figure 40. A Dry Napkin After Removing it from the Front Box*





*Figure 41. A Dry Napkin After Removing it from the Back Box*