

# **Production of Adalimumab: A Humira® Biosimilar**

A Technical Report submitted to the Department of Chemical Engineering

Presented to the faculty of the School of Engineering and Applied Science  
University of Virginia • Charlottesville, Virginia

In partial fulfillment of the requirements for the degree  
Bachelor of Science, School of Engineering

Spring 2022

## **Technical Project Team Members**

Taylor Bloom

Susan Furlough

William Gawrylowicz

Brandon Hudson

John Kilduff

1. Table of Contents
2. Summary
3. Introduction
  - 3.1. Motivation and Background
  - 3.2. Pharmacology
  - 3.3. Treatment and Dosage
  - 3.4. Plant Capacity
4. Discussion
  - 4.1. Upstream
    - 4.1.1. Cell Line Acquisition and Media Selection
    - 4.1.2. Inoculum Train
    - 4.1.3. Perfusion Reactor
    - 4.1.4. Tangential Flow Filtration and Recycle
  - 4.2. Downstream
    - 4.2.1. Depth Filtration
    - 4.2.2. Ultrafiltration
    - 4.2.3. Protein A Chromatography
    - 4.2.4. Viral Inactivation
    - 4.2.5. Diafiltration for Anion Exchange Chromatography
    - 4.2.6. Anion Exchange Chromatography
    - 4.2.7. Diafiltration for Cation Exchange Chromatography
    - 4.2.8. Cation Exchange Chromatography
    - 4.2.9. Viral Filtration
    - 4.2.10. Final Ultrafiltration and Diafiltration
    - 4.2.11. Formulation and Filling
    - 4.2.12. Lyophilization
  - 4.3. Ancillary Equipment
    - 4.3.1. Tank Design
    - 4.3.2. Pump Design
    - 4.3.3. Heat Exchanger
  - 4.4. Water for Injection (WFI) System Design
  - 4.5. Air Filtration System Design
  - 4.6. Disposal
    - 4.6.1. Liquid Waste
    - 4.6.2. Solid Waste
5. Final Design
  - 5.1. Upstream
    - 5.1.1. Cell Line Acquisition and Media Selection
    - 5.1.2. Inoculum Train
    - 5.1.3. Perfusion Reactor

- 5.1.4. Tangential Flow Filtration
- 5.2. Downstream
  - 5.2.1. Depth Filtration
  - 5.2.2. Ultrafiltration
  - 5.2.3. Protein A Chromatography
  - 5.2.4. Viral Inactivation
  - 5.2.5. Diafiltration for Anion Exchange Chromatography
  - 5.2.6. Anion Exchange Chromatography
  - 5.2.7. Diafiltration for Cation Exchange Chromatography
  - 5.2.8. Cation Exchange Chromatography
  - 5.2.9. Viral Filtration
  - 5.2.10. Final Ultrafiltration and Diafiltration
  - 5.2.11. Formulation and Filling
  - 5.2.12. Lyophilization
- 5.3. Disposal
  - 5.3.1. Liquid Waste
  - 5.3.2. Solid Waste
- 5.4. Material & Energy Balances
  - 5.4.1. Upstream Material & Energy Balances
  - 5.4.2. Downstream Material & Energy Balances
- 5.5. Equipment Tables and Specifications
  - 5.5.1. Upstream Equipment Table
  - 5.5.2. Downstream Equipment Table
  - 5.5.3. Ancillary Equipment Table
- 5.6. Production Schedule
- 5.7. Plant Location
- 5.8. Process Economics
  - 5.8.1. Plant Capital Costing
  - 5.8.2. FDA Approval and Validation Costs
  - 5.8.3. Operating Expenses
  - 5.8.4. Economic Analysis using Discounted Cash Flow
  - 5.8.5. Risk Analysis
- 5.9. Quality Control
- 6. Regulatory, Safety, Health, and Environmental Considerations
- 7. Social and Ethical Considerations
- 8. Conclusion and Recommendations
- 9. Acknowledgement
- 10. Table of Nomenclature
- 11. References
- 12. Appendix

## **2. Summary**

The purpose of this project was to design a continuous manufacturing process to produce adalimumab. Adalimumab is a monoclonal antibody (mAb) therapeutic that targets and blocks Tumor Necrosis Factor Alpha (TNF- $\alpha$ ), a protein which leads to inflammation in the body. Patients with autoimmune diseases produce too much TNF- $\alpha$  and may take adalimumab to treat the inflammation (Lee et al., 2019). Currently in the U.S., adalimumab is solely produced by AbbVie under the brand name of Humira®. It is consistently the top grossing drug with \$20.4 billion in 2020 sales (Mikulic, 2021). However, its patent is expiring in 2023, so other companies can begin producing Humira biosimilars such as the one being described in this report (Vaidya, 2021).

The manufacturing process described in this report makes use of continuous and single-use technologies. Continuous processing is advantageous because it increases plant capacity and lowers operating costs as storage needs are decreased and titers can be increased. Additionally, it requires less labor, reducing the chance for human error. (Yang et al., 2019). Likewise, implementing single-use technologies reduces labor requirements by decreasing the need for cleaning and sterilization of stainless steel equipment. Furthermore, avoiding the clean and sterilize-in-place procedures saves time and money. Single-use technologies also reduce the risk of cross contamination, which is vital in the biopharmaceutical industry (AIChE, 2019). While there are environmental concerns with the non-reusable plastic required for single-use processes, it requires less water and caustic chemicals that would be used for cleaning and sterilization (Flanagan et al., 2011).

The proposed process will produce 60 kg of adalimumab per year in six campaigns, each lasting 30 days. This will provide enough doses for approximately 58,000 patients, assuming that

all patients are taking a standard dose of Humira every two weeks. The designed process will only run for 7 months of a year, allowing the space to be used for other products throughout the other part of the year. The final product will be sold for 30% less than AbbVie's Humira with an estimated revenue of \$3.3 billion per year.

### **3. Introduction**

#### **3.1 Background and Motivation**

Despite being used by less than 2% of Americans, biologics account for approximately 40% of pharmaceutical expenditures in the United States (Sarpatwari et al., 2019, p. 92). One reason for the expensive nature of these drugs is the current patent system. Currently, when a company discovers a new drug, they are able to patent their discovery for up to 20 years (Raj et al., 2015). This prevents any other company from producing or selling a drug that serves the same function as the original discovery. This lack of competition allows for the original company to sell their drug at an expensive, uncontested price, which is justified by the company as the cost of developing a novel medicine. Because of this system, a select few companies are able to dominate the pharmaceutical industry. However, once these patents expire, other companies can introduce biosimilar drugs that serve as an approximation to the structure of the reference compound while demonstrating no clinically significant differences in quality, safety, and efficacy (Jacobs et al., 2016). Biosimilars have a great potential to lower the cost of these expensive therapeutics by introducing competition. For example, in the European Union, biosimilars have been found to cost 30% less than the brand name drug (Blackstone & Fuhr, 2013). In fact, this time period of patents expiring and biosimilars being developed is known as the “patent cliff” and often results in a drastic drop in revenue for the original company (Raj et al., 2015).

Due to mAb therapeutics being relatively new to the industry, many are still under patent with only 11 therapeutics having been approved biosimilar by the U.S. Food and Drug Administration (FDA) (*Biosimilar*, 2021). However, there are over 100 approved mAb therapeutics, meaning that many biosimilars will soon be entering the market. Adalimumab is of

particular interest as it is extremely expensive for patients. For example, it is consistently the top grossing drug despite only being the 152<sup>nd</sup> most prescribed (*The top 300 drugs*, 2021; Rowland, 2020). Proper treatment requires patients to receive a dose every two weeks and could cost up to \$72,000 per year, making it unaffordable for many patients (Coghlan et al., 2021, p.1576; Mikulic, 2021).

Adalimumab was first approved by the FDA in 2002 to treat rheumatoid arthritis and has since been approved to treat other diseases such as juvenile idiopathic arthritis, psoriatic arthritis, ankylosing spondylitis, Crohn's disease, ulcerative colitis, plaque psoriasis, hidradenitis suppurativa, and uveitis (*Humira*, 2002). AbbVie's patent will expire in 2023, allowing for biosimilars to enter the market (Vaidya, 2021). Currently, there are 6 adalimumab biosimilars approved with 3 more under review (*Market*, 2021). Therefore, this project aims to design a process to produce an adalimumab biosimilar in order to compete with AbbVie and these other companies to help make the medicine more affordable and accessible for patients. The proposed process will be continuous and implement single-use technologies whenever possible in order to reduce human labor needs and lower operating costs.

### **3.2 Pharmacology**

TNF- $\alpha$  is a naturally occurring cytokine that is an essential component of inflammatory and immune responses. In patients with such autoimmune or inflammatory diseases as rheumatoid arthritis, TNF- $\alpha$  plays a role in signaling the immune system to attack healthy cells, leading to painful inflammation in the joints of the body. Adalimumab is a fully human IgG1 monoclonal antibody that binds specifically to and inhibits the function of TNF- $\alpha$ . This binding prevents the interaction between TNF- $\alpha$  and the p55 and p75 cell surface receptors, thereby

blocking its cytokinetic effects and reducing the inflammatory response (Magenat et al., 2016).

Figure 3.2.1 provides a visual representation of the mechanism of action for adalimumab.

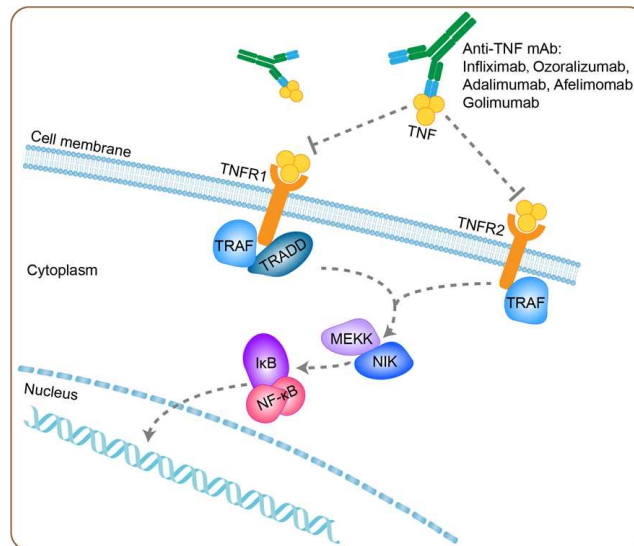

Figure 3.2.1. Mechanism of Action for Adalimumab (*Adalimumab Overview*, 2022)

The companies that have received FDA approval for adalimumab biosimilars have done so by demonstrating the physicochemical and pharmacological similarities between their product and the reference product (Hyland et al., 2016; Magenat et al., 2016; Schreiber et al., 2020). By establishing these similarities, the biosimilar product is ensured to have the same effect as the reference product. A few important characteristics in these studies are the molecular weight, approximately 150 kDa, and the isoelectric point, in the range of 8.0-9.3 (Schreiber et al., 2020).

### 3.3 Treatment and Dosage

The designed product will be a 40 mg dose of adalimumab, the standard Humira dosage that an adult patient would take every other week. The drug will be administered to the patient through subcutaneous injection by a prefilled syringe or pen (*Humira*, 2002). The active and inactive ingredients for a standard 40 mg dose of adalimumab are shown in Table 3.1 (*HUMIRA (adalimumab)*, 2002). The final product will be in a lyophilized (freeze-dried) state, and pharmacists and hospitals will be responsible for reconstituting the standard 40 mg dose with 0.8



mL of water for injection (WFI). A reasonable target purity for mAbs is 99% (Mendiratta et al, 2014). The adalimumab solution is preservative free, should be refrigerated between 2 °C and 8 °C, and should be shielded from light (*Humira*, 2002).

Table 3.3.1  
Adalimumab Formulation

Ingredients	Mass (mg)
Adalimumab	40
Sodium Chloride	4.93
Monobasic Sodium Phosphate Dihydrate	0.69
Dibasic Sodium Phosphate Dihydrate	1.22
Sodium Citrate	0.24
Citric Acid Monohydrate	1.04
Mannitol	9.6
Polysorbate 80	0.8
Sodium Hydroxide	Added to adjust pH to 5.2

### 3.4 Plant Capacity

In 2019, 553,816 people were estimated to be using Humira in the United States (*Adalimumab*, 2021). However, with less costly biosimilars, it is predicted that more people will begin buying and taking adalimumab. Historically, there has only been a 2-4% increase in demand for medicine with the addition of biosimilars (IQVIA Institute, 2020). With a growing trust in biosimilars, our team is predicting the addition of Humira biosimilars will increase demand by 4%. Therefore, a projected 576,000 people will be taking Humira or a biosimilar.

There is wide variation in how much of the market a biosimilar will take up. In Europe, where biosimilars have become well-established, they make up about 46% of the market for monoclonal antibodies (Chen et al., 2021). Additionally, in the United States, oncology

biosimilars within one year of release have been able to take up almost half of the market. Therefore, we believe that it is a reasonable estimate for all adalimumab biosimilars to take up around 40% of the market once they are launched.

Currently, there are nine companies which have reached settlements with AbbVie to make adalimumab biosimilars in the United States once the Humira patent expires (Jochin, 2020). In Europe, the top 3 adalimumab products control 94% of the market, including AbbVie (Chen et al., 2021). There were only 5 adalimumab biosimilars released in Europe, meaning approximately 40% of the biosimilars hold a significant market share (*Adalimumab biosimilars*, 2020). We will use a similar success ratio and assume four of the nine American biosimilars take up a significant portion of this market. Our product will then aim to take up 10% of the total 576,000 people taking adalimumab. Additionally, with the assumption that most patients are taking a dosage of 40 mg every other week, the mass that we want to generate every year can be calculated to be 60 kg. Assuming 6 campaigns lasting 30 days can occur per year, this process will produce 10 kg per campaign. Therefore, this process will only be run for 7 months of the year. While this is a starting point for our process, it is likely that as more biosimilars become available, more patients will begin taking adalimumab and we will sell more doses. By only running for 7 months, our plant has the capacity to produce more adalimumab in the future by adding more campaign

## 4. Discussion

### 4.1 Upstream Process

Figure 4.1.1 summarizes the upstream processing of adalimumab. The proposed process implements single-use technologies and is operated at 33 °C. The final product will be a solution of adalimumab, cell debris, and leftover substrate that will be purified in the downstream process detailed in section 4.2. This process produces 12.8 kg of adalimumab per campaign.

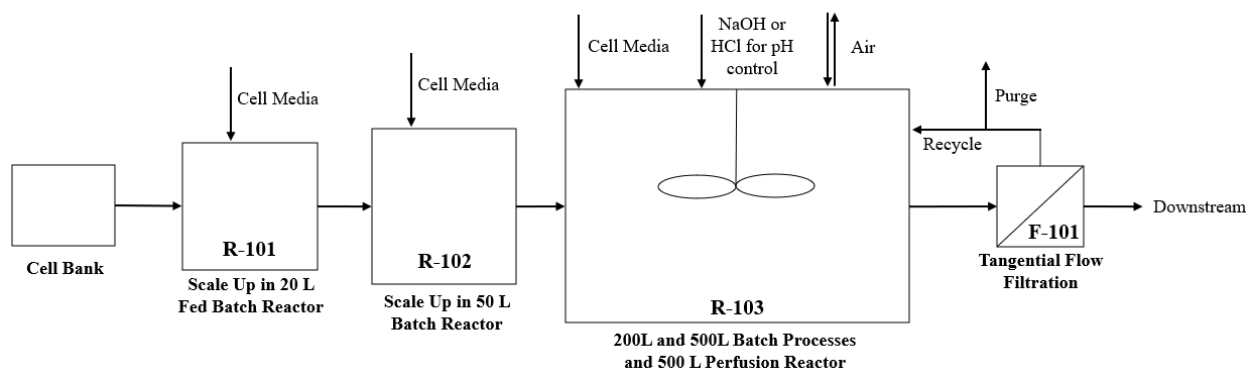

Figure 4.1.1. Overall Upstream Process Flow Diagram

#### 4.1.1 Cell Line Acquisition and Media Selection

Chinese Hamster Ovary (CHO) cells are the industry standard for the production of biotherapeutics due to their ability to fold, modify, and excrete proteins. With particular genetic modifications, they can be selectively tailored to produce protein and antibodies that can subsequently be used to treat a wide variety of diseases. Six companies have developed unique parent cell lines through genetic modifications to produce antibodies that show physiological and pharmacological biosimilarity to AbbVie's adalimumab (Hyland et al., 2016). Since these biosimilars have received the required regulatory approval from the FDA, our design will be functional for a master cell bank from any one of these biosimilars. The cell bank will be distributed and stored in 4.5 mL vials, each at a concentration of  $50 \times 10^6$  cells/mL. These high density vials allow for a significant reduction in scale-up time and labor than traditional lower

density vials while still meeting GMP requirements (Cytiva, 2020f). The cells will be stored at -86 degrees Celsius in a VIP ECO Model MDF-DU702VH-PA Freezer (PHCBi, 2021). Before cells can be grown in the inoculum train, they must be thawed. This will be done with the Thermo Fisher Precision GP 02 water bath, which has 2L of water and has a temperature range of room temperature to 100 degrees C (Thermo Fisher Scientific, 2022).

#### 4.1.2 Inoculum Train

In order to prepare the initial cell bank for operation in a perfusion bioreactor, the system must be scaled to the required working volume. To model this process, Type I fermentation and Monod kinetics were assumed. In Type I fermentation, it is assumed that the protein production rate is directly related to and dependent on cell growth (Prpich, 2021c). The Monod equation (Equation 4.1.1) shows the relationship between the specific growth rate,  $\mu$ , of a microorganism and the concentration of substrate present,  $S$ .  $\mu_{max}$  is the maximum value of the specific growth rate reached in the exponential phase, and  $K_s$  is the monod saturation constant which describes the concentration at which the specific growth rate has reached half of its maximum value, or one half of  $\mu_{max}$ .

$$\mu = \frac{\mu_{max}S}{K_s + S}$$

Equation 4.1.1. The Monod Equation for Cell Specific Growth Rate

The kinetic values used were determined in a study involving recombinant CHO cells producing infliximab (López-Meza, 2016). Infliximab, like adalimumab, is an IgG monoclonal antibody. Since it is only 1 kDa less in molecular weight than adalimumab, the kinetic parameters found in this study can be used for this process and are shown in Table 4.1.1. These parameters were found using glucose as a substrate, and therefore glucose was used as the primary substrate in subsequent calculations.

Table 4.1.1  
Kinetic Constants Used for Fermentation Calculations

$\mu_{\max}$	$K_s$	$Y_{X/S}$	$Y_{P/S}$
0.04 h <sup>-1</sup>	0.664 g/L	1.436 g/g	0.25 g/g

To begin the inoculum train, one high density cell vial will be thawed in 1 L of culture media to a temperature of 33°C and placed into the ReadyToProcess WAVE 25 Rocker Reactor produced by Cytiva (Cytiva, 2022g). This reactor is single-use and is able to operate in a media addition mode with working volumes up to 25 L. It will be equipped with a compatible 20 L single-use cellbag. Two will be purchased to ensure that there is a backup reactor available if needed. Media will be added to the reactor in a fed-batch operation until the system reaches a total volume of 20 L. Fed-batch was found to be advantageous to batch for this initial scale-up step because of its tendency to yield higher titer and reduce overall manufacturing costs (Xu et al., 2020). The volume, cell, substrate, and product balances are shown in Equations 4.1.2-5 where V is volume, X is concentration of CHO cells, S is concentration of glucose, P is the concentration of adalimumab, and F is the flow rate of cell media into the wave reactor.

$$\frac{dV}{dt} = F$$

Equation 4.1.2. Change in Volume in Fed-Batch Reactor

$$\frac{dX}{dt} = \left(\mu - \frac{F}{V}\right)X$$

Equation 4.1.3. Change in Cell Concentration in Fed-Batch Reactor

$$\frac{dS}{dt} = \frac{F}{V}(S_0 - S) - \frac{\mu X}{Y_{X/S}}$$

Equation 4.1.4. Change in Substrate Concentration in Fed-Batch Reactor

$$\frac{dP}{dt} = \frac{\mu X}{Y_{X/P}} - \frac{F}{V}P$$

Equation 4.1.5. Change in Product Concentration in Fed-Batch Reactor

Equations 4.1.2-5 were solved in MATLAB for different inlet flow rates. The inlet flow rate determines the duration of the fed-batch operation. Figure 4.1.2 shows the final cell concentration that is achieved as a function of fed-batch duration. As shown in the figure,

operating for greater than 190 hours does not significantly increase the cell concentration. Therefore, 0.1 L/h was chosen to be the optimal feed flow rate and results in a final cell, substrate, and product concentrations of 8.50, 0.10, and 1.48 g/L respectively. In the future, the low substrate concentration should be studied to ensure that the CHO cells do not starve. Cell starvation is a concern because the cells could use adalimumab as a nutrient source or they could die, reducing cell and product concentration.

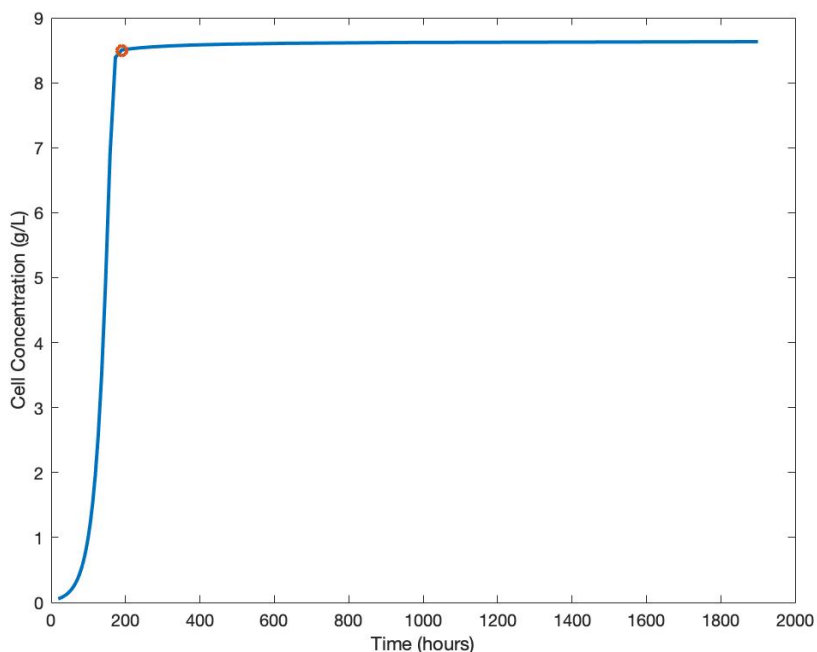

Figure 4.1.2. Cell Concentration Achieved at Various Fed-Batch Operation Times

The solution will then undergo three subsequent batch processes at 50, 200, and 500 L. These batch processes will be performed in Cytiva's Xcellerex XDR single-use bioreactors with the 50 L batch process being performed in a 50 L reactor and the 200 and 500 L batch process being performed in a 500 L reactor. Two 50 L and three 500 L reactors will be purchased. This will allow for the inoculum train to begin while another campaign is in perfusion mode, and it will ensure that there is a backup reactor available if needed. Batch processes were chosen as it allows for a higher growth rate than fed-batch (Prpich, 2021b).

For each step, cell media will be added until the desired final volume is reached. Additionally, solid glucose will be added to bring the glucose concentration to 6 g/L, the initial concentration of the media. The process will then be allowed to run until the glucose concentration drops to 2 g/L. Concentrations below 2 g/L were shown by López-Meza to cause a significant decrease in cell growth and maximum cell density. After the 500 L batch process is completed, the reactor will be set to perfusion mode. Equations 4.1.6-8 show the cell, substrate, and product balances for the batch processes where the variables are the same as in the fed-batch process above.

$$\frac{dX}{dt} = \mu X$$

Equation 4.1.6. Change in Cell Concentration in Batch Reactor

$$\frac{dS}{dt} = - \frac{\mu X}{Y_{X/S}}$$

Equation 4.1.7. Change in Substrate Concentration in Batch Reactor

$$\frac{dP}{dt} = \frac{\mu X}{Y_{X/P}}$$

Equation 4.1.8. Change in Product Concentration in Batch Reactor

The equations shown above were modeled in Excel. From the data, after approximately 286 hours, the cell, substrate, and product concentrations in the bioreactor at the start of perfusion operation will be 8.96, 2.00, and 1.56 g/L. Table 4.1.2 summarizes the batch processes explained above. Figure 4.1.3 shows the cell, substrate, and product concentrations as a function of time for the entire inoculum train.

Table 4.1.2

Overview of Batch Process in Inoculum Train

Batch Volume (L)	Volume of Media Added (L)	Mass of Glucose Added (g)	Time of Batch (h)	Material	Starting Concentration (g/L)	Final Concentration (g/L)
50	30	298.1	29	Cell Product	3.40 0.59	9.14 1.59
200	150	1100	36.7	Cell Product	2.29 0.40	8.03 1.40
500	300	2600	30	Cell Product	3.21 0.56	8.96 1.56

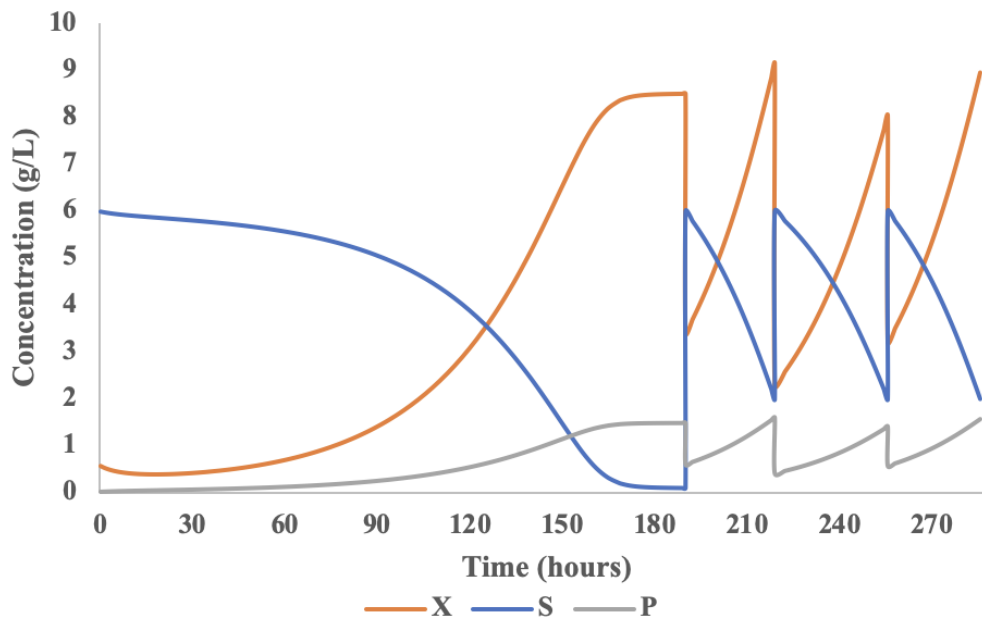

Figure 4.1.3. Inoculum Train Cell, Substrate, and Product Concentration as a Function of Time

### 4.1.3 Perfusion Bioreactor

Perfusion operation was chosen over batch and fed-batch operation as cells can be maintained in the exponential growth phase for longer and therefore higher cell densities can be reached (Cytiva, 2020f). The perfusion bioreactor that was selected was a 500 L Cytiva's Xcellerex XDR single-use stirred tank bioreactor. As previously mentioned, three of these bioreactors will be purchased so that the batch scale up and perfusion can occur simultaneously



while a third is available as a backup in case there is issue with either of the other bioreactors. This bioreactor was selected due to the multiple features. The XDR bioreactor is single-use, utilizing disposable bags and impellers which can be utilized for each campaign and then disposed of after. This will ensure that the bioreactor is sterile at the beginning of each campaign, as well as minimizing the time and labor required for cleaning and sterilization between campaigns. This bioreactor is commonly used in industry as it is reliable and utilizes a configurable design in order to optimize and process. The dimensions of the bioreactor are summarized in Figure 4.1.4.

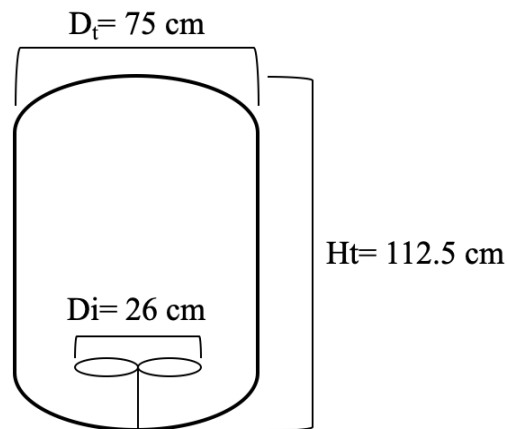

Figure 4.1.4. Perfusion Bioreactor Dimensions

Perfusion campaigns will be run for 30 days where product will be continuously collected from the reactor. This length will allow for cells to be continuously grown while the potential for contamination is minimized.

The design of aerobic bioreactors involves many factors which must be carefully considered and controlled throughout the perfusion campaign. Any of such reactors requires the optimization of mixing and agitation, aeration, and geometry to satisfy the demand for oxygen transfer to the cells. A mathematical model of the reactor conditions indicates that the oxygen uptake rate (OUR) should be equal to the oxygen transfer rate (OTR). This relationship is

defined in equation 4.1.9, where the first bracketed term in this equation represents the oxygen transfer rate and the second bracketed term represents the oxygen uptake rate.

$$\frac{dC_{O_2}}{dt} = \left[ k_L a (C_{O_2}^* - C_{O_2}) \right] - \left[ \frac{1}{Y_{X/O_2}} \mu X \right]$$

Equation 4.1.9. Change in oxygen concentration over time

$C_{O_2}^*$  is the saturation constant,  $Y_{X/O_2}$  is the oxygen yield coefficient,  $C_{O_2}$  is the concentration of oxygen, and  $X$  is the concentration of cells. The term  $k_L a$  symbolizes the oxygen transfer coefficient and is of vital importance to bioreactor design. Since the change in  $C_{O_2}$  must remain constant throughout operation, we can simplify equation 4.1.9 into equation 4.1.10, where  $Q_{O_2}$  is the specific oxygen demand, or  $\mu$  divided by  $Y_{X/O_2}$ . The value of  $Q_{O_2}$  and  $C_{O_2}$  were calculated through data found in literature on the estimation of oxygen uptake in mammalian cell culture (Goudar, Piret, & Konstantinov; 2011).

$$target\ k_L a = \frac{Q_{O_2} X}{C_{O_2}^* - C_{O_2}}$$

Equation 4.1.10. Definition of the target kLa

This equation also results in  $C_{O_2}$  becoming the critical dissolved oxygen level, or  $C_{crit}$ . This simplification allows for the calculation of the  $k_L a$  required to support the maximum rate of oxygen uptake, thus designating the target we must achieve with the mixing, agitation, and aeration calculations. The constant parameters used and the results of these calculations are summarized in table 4.1.3.

Table 4.1.3  
Calculation of Target  $k_L a$  for Perfusion Bioreactor Design

Parameter	Value (units)
X	8.956 g/L
$C_{O_2}^*$	7.2 mg/L
$C_{crit}$	1.432 mg/L
$Q_{O_2}$	0.0865 mmol $O_2$ / (g X × h)
Target $k_L a$	4.3 h <sup>-1</sup>

With target  $k_L a$  defined, we proceed to mixing, agitation, and aeration calculations. The dimensions of the selected bioreactor, at a 500 L working volume, give a tank diameter,  $D_t$ , and liquid height,  $H_L$ , of 0.750 meters. The diameter of the impeller,  $D_i$ , is 0.263 meters, and the cross-sectional area of the tank is calculated to be 0.442 m<sup>2</sup>. For agitation and aeration, we selected an impeller speed,  $N$ , of 200 RPM and a  $Q_g$  of 0.002 vvm.  $Q_g$  is the aeration rate, a value typically reported in vvm as it is a measure of air flow with respect to reactor volume. There are a number of models that describe  $k_L a$  in terms of  $Q_g$ ,  $V$ ,  $D_t$ , and the superficial velocity,  $v_s$ . In our calculations, we use the model given by equation 4.1.11 (Prpich, 2021d).

$$k_L a = \frac{0.0333}{D_t^4} \left( \frac{P_g}{V} \right)^{0.541} Q_g^{\frac{0.541}{\sqrt{D_t}}}$$

Equation 4.1.11. Predictive Model for  $k_L a$

The remaining unknown in this model is  $P_g$ , or the total power input required for the system. The power number and aeration number,  $N_p$  and  $N_a$ , respectively, are necessary to calculate  $P_g$ . The manufacturer of our bioreactor system provides  $N_p$  as 1.15, which then results in a value of 52.8 W for  $P$ , based on equation 4.1.12, where  $\rho$  is the fluid density.

$$P = N_p \rho N^3 D_i^5$$

Equation 4.1.12. Power Consumption

The aeration number is calculated using  $Q_g$ ,  $N$ , and  $D_i$ , and then immediately used the relevant correlations to determine a value of 0.99 for  $P_g/P$ . This immediately results in the calculation of  $P_g$  to a value of 49.8 W, which is the total power input required for the perfusion system. Inputting this value into the  $k_{L,a}$  model, we calculate  $k_{L,a}$  as  $4.7 \text{ h}^{-1}$ , which is within the general requirement for the  $k_{L,a}$  to be within 10% of the target value.

With our bioreactor design specifications complete, we must check certain parameters against general rules of thumb for bioreactor design. The comparison of our design calculations versus each of these rules is given in table 4.1.4. Note that  $v_s$  represents the superficial velocity. Since all of our specifications satisfy these rules, we are able to move on and solve the material balances.

Table 4.1.4  
General Rules of Thumb for Bioreactor Design

Rule	Requirement	Design Value	Agreement
Avoid Slugging	$v_s = \frac{Q_g}{A_t} < 125 \text{ m/h}$	0.14 m/h	Yes
Avoid Flooding	$Q_g \leq 0.6 \left( \frac{D_i^5 N^2}{D_t^{1.5}} \right)$	$1.6 \cdot 10^{-5} \leq 0.0128$ units = $\text{m}^3/\text{s}$	Yes
Number of Impellers	$\frac{H_L - D_i}{D_i} \geq n_i \geq \frac{H_L - 2D_i}{D_i}$	$1.9 \geq 1 \geq 0.9$	Yes
Sufficient Shear	$\pi N D_i > 2.5 \text{ m/s}$	2.749 m/s	Yes
Energy Input	$\frac{P_g}{V} < 15,000 \text{ W/m}^3$	99.6 $\text{W/m}^3$	Yes

When these reactor conditions are taken into account, it becomes possible to solve the material balances surrounding the reactor. The reactor functions at steady state as fresh media

enters the reactor and cells and spent media leave to go through TFF. Cells do not pass through the TFF membrane and are either purged from the reactor to maintain an equilibrium amount of cells in the reactor, or recycled back into the reactor. The TFF permeate consists of a small amount of cell debris along with the mAb product to be further processed in the following steps.

When evaluating the kinetics of this continuous bioreactor with recycle, it is important to keep in mind the dilution rate, or  $D$ , which is defined as the flow into the reactor divided by the volume of the reactor.

$$D = \frac{F_0}{V}$$

Equation 4.1.13. Dilution rate

The dilution rate has a large effect on the amount of cells produced along with the consumption of substrate. Assuming that the amount of cells produced (defined by  $DX$ ) is proportional to the amount of product produced, the goal is to maximize productivity. This can be achieved by creating a model with the Monod equations for a continuous bioreactor with recycle (Prpich, 2021a).

$$D = \frac{\mu_{max} S}{(K_s + S)(1 - a(b - 1))}$$

Equation 4.1.14. Definition of the dilution rate as dependent on substrate consumption and kinetic variables

$$S = \frac{DK_s(1 - a(b - 1))}{\mu_{max} - D(1 - a(b - 1))}$$

Equation 4.1.15 Kinetic equation to describe the substrate in the bioreactor based on  $D$ , recycle ratio, and concentration factor

$$X = Y_{x/s}(S_0 - S)$$

Equation 4.1.16. Cell growth, defined by substrate consumption and the yield of cells per amount of substrate consumed

$$b = \frac{X_r}{X_1}, \quad a = \frac{F_r}{F_0}$$

Equation 4.1.17. Definitions of the concentration factor (b) and recycle ratio (a)

Using equations 4.1.14 to 4.1.17 and the known variables in our system, we utilized MATLAB to create a model of our system which can be seen in Figure 4.1.5. In this figure, it can be seen that the DX curve reaches a maximum at  $D_{opt} = 0.042 \text{ h}^{-1}$  and that it crosses the x-axis at  $D_{washout} = 0.055 \text{ h}^{-1}$ . When determining what dilution rate to run at, it is important to not run above  $D_{opt}$  in order to avoid washout, which occurs at  $D_{washout}$ . Therefore, we chose to run our process at  $D = 0.04 \text{ h}^{-1}$  as this is where there is maximum productivity.

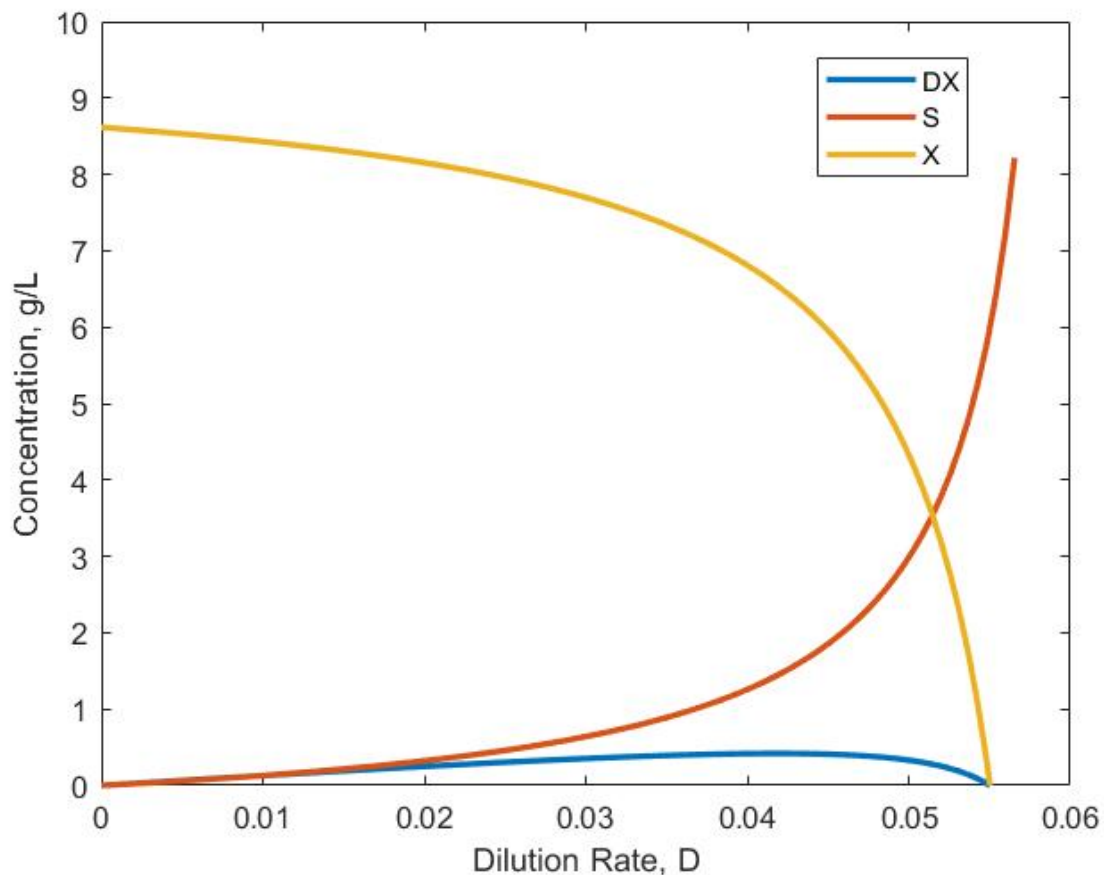

Figure 4.1.5. Substrate consumption, cell production, and productivity for our continuous bioreactor with recycle

At this set dilution rate, set product outlet concentrations and flow rates, and set glucose concentration for the feedstock, we were able to calculate the purge flow rate and inlet flow rate with monod kinetics and material balances as discussed in the following section. The feed flow

rate was determined to be 0.35 L/min at 6 g/L of substrate concentration for the duration of the 30 day campaign.

#### 4.1.4 Tangential Flow Filtration and Recycle

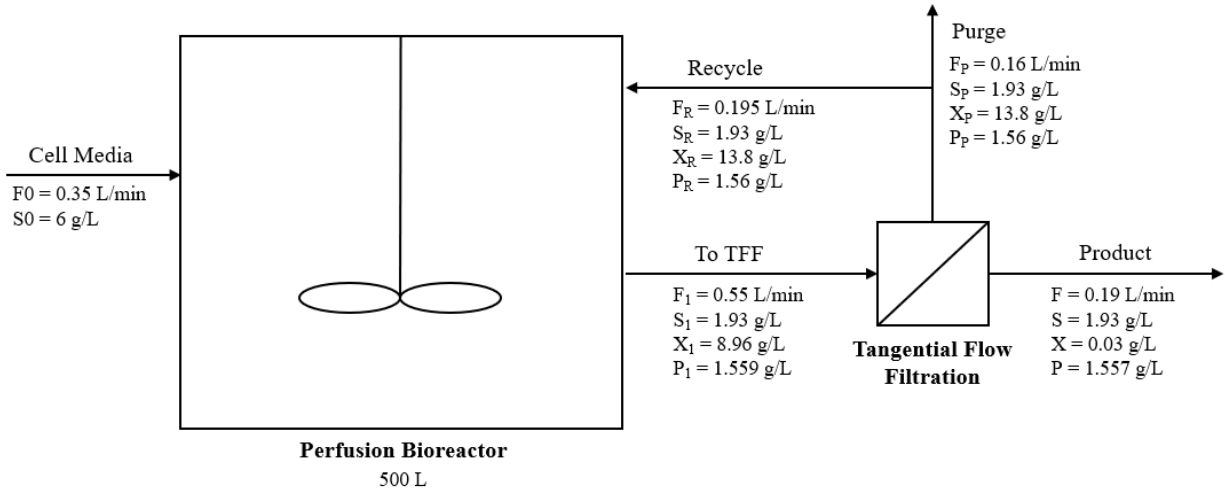

Figure 4.1.6. Stream flow rates around perfusion system and TFF

Tangential Flow Filtration (TFF) is designed to separate the mAbs and other small debris from the larger cells. A continuous, laminar flow comes off the perfusion reactor and flows tangentially against the TFF filter, where pressure is controlled to determine the flow rates of the separated product (Liu et al., 2010). The concentration of antibodies entering and leaving TFF will remain the same, aside from the loss of 0.1% of antibodies due to the rejection coefficient.

The process involves 35% of the 550 mL/min flow passing through TFF into the product stream, leaving the remaining 65% to be recycled or purged. The purpose of a recycle stream is to maintain a constant concentration of cells in the perfusion reactor. To determine the exact flow rate of the recycle stream, a cell balance was performed with equations 4.1.18 and 4.1.19.

$$\text{Accumulation of Cells} = 0 = \text{Cells Growth} - \text{Cells Leaving Reactor} + \text{Cells Recycled}$$

Equation 4.1.18. General Cell Balance on Perfusion Reactor

$$0 = \mu XV - F_1 X + F_R X_R$$

Equation 4.1.19. Cell Balance on Perfusion Reactor

Because of the assumption that the perfusion reactor is perfectly stirred, the concentration of cells in the reactor is the same as those leaving the reactor. The concentration of cells in the recycle stream is the same as that of the purge stream and is described by equation 4.1.20.

$$X_R = X_P = \frac{0.999 F_1 X}{F_R + F_P}$$

Equation 4.1.20. Concentration of Cells in the Recycle and Purge Stream

While the flow rates of the purge and recycle stream are unknown variables in these equations, their sum is known to be 65% of the flow entering TFF. This results in a concentration of 13.8 g/L of cells being recycled. To fulfill the cell balance, a recycle flow rate of 195 mL/min was needed, resulting in the remaining 160 mL/min being purged.

Sartocon® Slice Disposable Hydrosart® Cassettes from Sartorius will be used as the tangential flow filters for this process. They are single use and have the recommended pore size of 20 µm for TFF (Liu et al., 2010). The specification sheet states that these filters have over a 99% percent retention of cells which are recycled to the reactor. The 0.1 m<sup>2</sup> filters were selected to accommodate the recommended 2100  $\frac{L}{hr \cdot m^2}$  flow velocity (Sartocon®, 2022). The permeability factor was calculated to be  $3.89 \times 10^{-9}$  using equation 4.1.21, where  $\bar{v}$  is flow velocity (m/s) and  $\Delta P$  is the maximum transmembrane pressure. Equation 4.1.21 was then used again to calculate the actual transmembrane pressure using the flow velocity specific to this process. The actual transmembrane pressure is 0.082 bar.

$$permeability\ factor = \frac{\bar{v}}{\Delta P}$$

Equation 4.1.21. Permeability Factor for Tangential Flow Filtration



## 4.2 Downstream Process

Figure 4.2.1 summarizes the downstream processing of adalimumab. The proposed downstream process has an overall adalimumab recovery of 78.7%. All process steps following the first ultrafiltration stage will be performed at room temperature, 20 °C, by cooling the solution in a heat exchanger before Protein A chromatography.

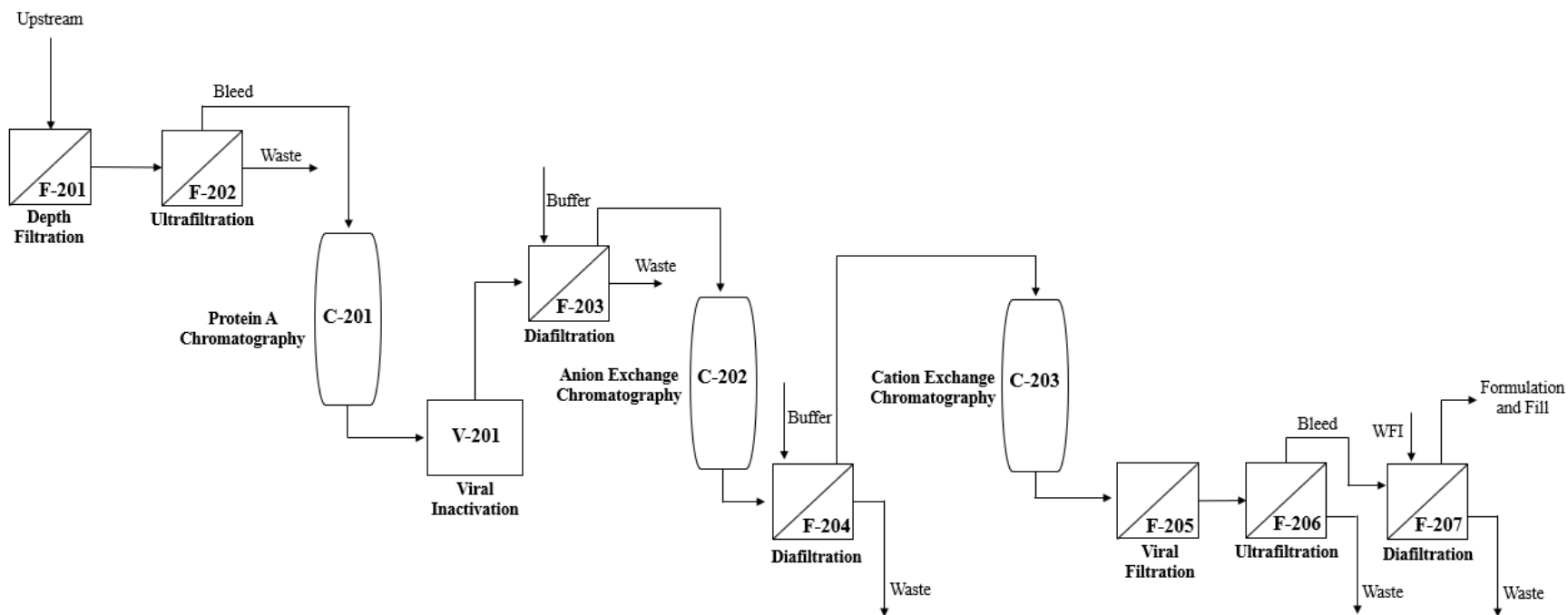

Figure 4.2.1. Overall Downstream Process Flow Diagram

### **4.2.1 Depth Filtration**

After TFF, depth filtration will be implemented to remove any large impurities such as lysed cell debris. For this stage, a Millistak+® Pod Disposable Depth A1HC Filter will be used (Merck KGaA, 2021a). This filter system was chosen due to being single-use, being available in many different sizes, and having small hold up volumes. Additionally, the A1HC filter media is specifically advantageous as it consists of different filter media to ensure that filters downstream are protected from large debris. Typically, these filters are operated at 100 to 600 LMH. Therefore, since the flow rate is 191.90 mL/min, the 270 cm<sup>2</sup> membrane area was chosen as this results in operating at 426 LMH. Since only one filter system is being used, a 99% recovery will be assumed (Yigzaw et al., 2008). Therefore, the concentration will drop from 1.56 g/L to 1.54 g/L in this stage. It will also be assumed that the filter is operated at the system's maximum operating pressure of 2.07 bar. These filters will be replaced at the end of each campaign.

### **4.2.2 Ultrafiltration**

In order to minimize the buffer and WFI requirements in downstream processing, the solution exiting depth filtration will be concentrated before Protein A chromatography. To concentrate the solution, ultrafiltration will be used. Ultrafiltration is a common separation technique that uses permeable membrane filters that separates components according to molecular size. In ultrafiltration, a dilute solution will flow over the membrane with some passing through the membrane and being lost in the permeate while the molecule of interest is retained. As no new solution is being fed, there is a reduction in volume, and thus the retentate becomes concentrated.

In general, a membrane should be chosen that has a nominal molecular weight cutoff (NMWC) that is 3 to 5 times smaller than the target molecule (Cytiva, 2021). As adalimumab is

approximately 150 kDa, all ultrafiltration and diafiltration membranes chosen for this process have a NMWC of 30 kDa to ensure almost complete separation (Pedersen et al., 2021).

Therefore, it will be assumed that the chosen membranes will have a rejection coefficient of 0.999 for adalimumab. Constant flux across the filter membrane, no cake formation on the surface of the membrane, and no concentration polarization will also be assumed due to operating at low flow rates (Carta, 2021).

This stage was designed in order to ensure that a final concentration of 50 mg/mL is achieved at the end of the downstream process. This is the concentration of the standard dose of Humira, and therefore it was assumed that this was the highest concentration that could be achieved without the risk of aggregate formation. Implementing this constraint, the solution must exit this stage at a flow rate of 27.78 mL/min and a concentration of 10.59 mg/mL. Therefore, with the incoming stream at a concentration of 1.54 mg/mL and a rejection coefficient of 0.999, the concentration of adalimumab being lost in waste is 0.01 mg/mL at a flow rate of 164.12 mL/min, resulting in 99.4% recovery of adalimumab.

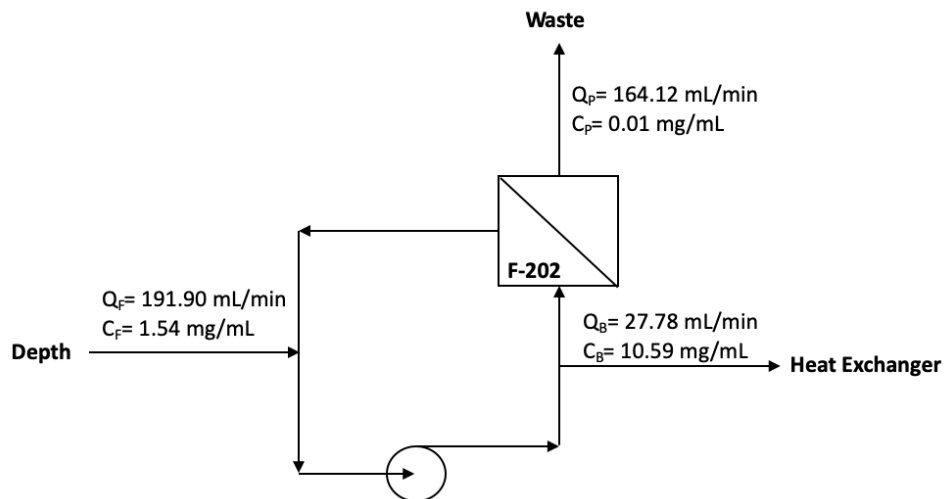

Figure 4.2.2. Block Flow Diagram with Balanced Streams for Ultrafiltration before Downstream Processing

The ÄKTA Flux 6 tangential flow filtration system produced by Cytiva will be used. Although not single-use, this system was chosen for its ability to operate at flow rates between 20 and 1000 mL/min (Cytiva, 2022a). The system will be fitted with Cytiva’s compatible Start AXH ultrafiltration hollow fiber cartridges. These cartridges are made to operate at small scales and minimize concentration polarization due to sweeping action created by a recirculation pump (Cytiva, 2022g). The UFP-30-C-2U cartridge was chosen and consists of 12 tubes with diameters of 0.05 cm. The membranes are 30 cm long, resulting in a total surface area of 50 cm<sup>2</sup>. Using the equations below where  $Q_t$  is flow rate per tube,  $d_t$  is tube diameter,  $L$  is tube length,  $\nu$  kinematic viscosity, and  $\rho$  is density, the pressure drop was found to be approximately 0.393 bar. The kinematic viscosity and density were approximated using the properties of water at 33°C. 0.393 bar is below the cartridge's maximum operating pressure of 3.4 bar, making these cartridges suitable for this diafiltration stage. This system will be cleaned in between each campaign with a sodium hydroxide solution.

$$Re = \frac{4Q_t}{\pi d_t \nu}$$

Equation 4.2.1. Reynolds Number Equation for Flow Through a Tube

$$f = \frac{16}{Re}$$

Equation 4.2.2. Friction Factor for Laminar Flow Through a Tube

$$\frac{\Delta P}{L} = \frac{32}{\pi^2} \frac{f \rho Q_t^2}{d_t^5}$$

Equation 4.2.3. Pressure Drop for Flow Through a Tube

### 4.2.3 Protein A Chromatography

The initial capture step beyond simple filtration in many biopharmaceutical downstream processes is chromatography, where a clarified cell culture supernatant is passed over a column that selectively binds the desired product. The platform chromatographic technique in mAb production processes is protein A chromatography, a type of affinity chromatography that

employs *Staphylococcal* protein A ligands in the resin that are able to bind to the Fc region of IgG antibodies of subclasses 1, 2, and 4 with high selectivity (Kanje et al., 2020). When introduced to the column under specific pH and flow velocity conditions, the product in the supernatant stream begins to bind to the column until it has reached the dynamic binding capacity (DBC). The buffers used in our chromatography design are listed in Table 4.2.1. Salt and buffer selection are made with respect to the study from Cytiva (2020c).

Table 4.2.1  
Salts and Buffers for Protein A Chromatography

<b>Phase</b>	<b>Flow Components</b>
Load	mAb solution from Depth Filtration
Wash	20 mM sodium phosphate, 0.5 M NaCl, pH 7.0
Elute	50 mM sodium acetate, pH 3.5
Clean	1 M NaOH
Regenerate	100 mM phosphoric acid, pH 2
Equilibrate	20 mM sodium phosphate, 0.5 M NaCl, pH 7.0

For this process, we selected the MabSelect Sure™ LX protein A resin by Cytiva due to the resin's high dynamic binding capacity specifically at higher residence times and higher titers, such as those used in this process (Cytiva, 2020e). The dynamic binding capacity for the resin is plotted in Figure 4.2.3 versus residence time.

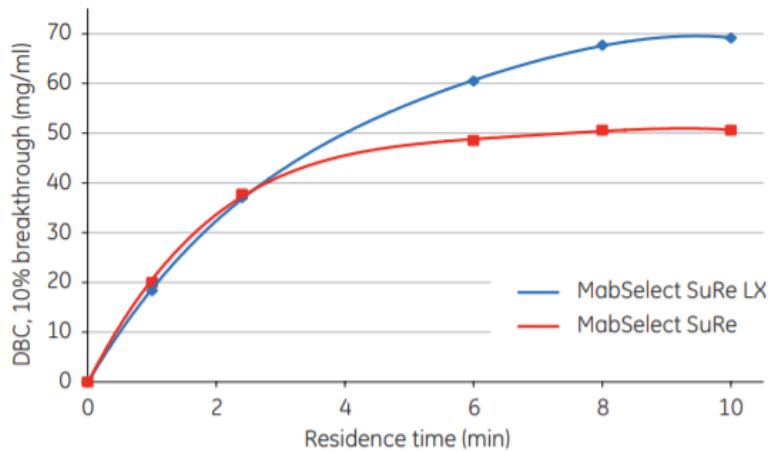

Figure 4.2.3. DBC<sub>10%</sub> of MabSelect SuRe (and LX) versus Residence Time (Cytiva, 2020c)

With reference to a study from Cytiva (2020c), a residence time of 6 minutes was chosen for optimal production, corresponding to a dynamic binding capacity of 60 mg/mL. This process will use Cytiva’s HiScale 50/20 columns, which have an inner diameter of 5.0 cm and a maximum bed height of 20.0 cm (Cytiva, 2022e). The 5.0 cm diameter corresponds to a cross-sectional area of 19.635 cm<sup>2</sup> for the column. Using this area with the volumetric flow rate of 27.78 mL/min of supernatant entering the column, the required linear flow velocity is 84.88 cm/hr, which is well within the upper limit for this resin (Cytiva, 2020c). With the linear flow velocity and the residence time of 6 minutes specified, the required bed height is 8.5 cm, resulting in a total column volume of 166.68 cm<sup>3</sup>. It should be noted that the bed heights of the HiScale columns used are adjustable to accommodate for different process requirements. The column volume then allows for the calculation of the load volume, given by Equation 4.2.4, resulting in a value of 944.25 mL.

$$DCB_{10\%} = \frac{V_{load} C_F}{V_{column}}$$

Equation 4.2.4. Relationship between dynamic binding capacity, feed concentration, column volume, and load volume

Finally, the pressure drop across the column was determined using the Carman-Kozeny equation (Equation 4.2.5), where  $d_p$  is the average particle diameter, 85  $\mu$ m, L is the column

length, and  $\varepsilon$  is the extraparticle porosity, assumed to be 0.3. The resulting pressure drop from this calculation is 0.765 bar, which is below the maximum allowable pressure drop of 1.38 bar (GE Healthcare, 2020b).

$$\Delta P = \frac{150(1-\varepsilon)^2}{d_p^2 \varepsilon^3} \times Lu\eta$$

Equation 4.2.5. Carman-Kozeny Equation for Chromatography Column Pressure Drop

In order to ensure continuous downstream processing, the protein A unit operation requires careful scheduling. Our proposed schedule for three columns in a continuous cycle is outlined in Table 4.2.2. Here, CVs refers to column volumes, a standard unit of measurement in chromatographic processes. In order to operate continuously, at least one column will need to be loading and one will need to be eluting at all times. With the proposed schedule for a single column, operation of three columns staggered to begin loading immediately after the preceding column finishes loading would achieve continuity in both loading and product streams. In addition, there will be a fourth column on hold in case of issues with the three in operation. This operation will occur with an inlet concentration of 10.59 mg/mL and flow rate of 27.78 mL/min, and an outlet concentration of 30.18 mg/mL and flow rate of 9.26 mL/min, which corresponds to a recovery of 95% of mAb.

Table 4.2.2  
Scheduling for Protein A Chromatography

Column 1	30 CV				3 CV	10 CV			3 CV	3 CV	3 CV
	27 mL/min				27 mL/min	9.26 mL/min			9.26 mL/min	9.26 mL/min	9.26 mL/min
	Load				Wash	Elute			Clean	Regenerate	Equilibrate
Column 2	10 CV	3 CV	3 CV	3 CV	30 CV			3 CV	10 CV		
	9.26 mL/min	9.26 mL/min	9.26 mL/min	9.26 mL/min	27 mL/min			27 mL/min	9.26 mL/min		
	Elute	Clean	Regenerate	Equilibrate	Load			Wash	Elute		
Column 3	3 CV	10 CV			3 CV	3 CV	3 CV	30 CV			
	27 mL/min	9.26 mL/min			9.26 mL/min	9.26 mL/min	9.26 mL/min	27 mL/min			
	Wash	Elute			Clean	Regenerate	Equilibrate	Load			

This schedule allows 180 minutes for loading, 18 minutes for washing, 180 minutes for elution, 54 minutes for cleaning, 54 minutes for regeneration, and 54 minutes for equilibration for a single column per cycle. This corresponds to a total cycle time of 540 minutes, thus mandating 80 cycles over a 30 day campaign. The selected resin has been demonstrated to maintain performance through 100 cycles of operation, so the columns need not be replaced during the campaign (GE Healthcare, 2011). Columns will be disposed of following each campaign according to the methods described in section 4.6.2.

#### 4.2.4 Viral Inactivation

Following protein A chromatography, a viral clearance step will be performed. FDA regulations require that there be less than 1 virus per million doses and that there are three separate methods for viral clearance (van Reis and Zydney, 2007). One such method for viral inactivation (VI) is holding the product at a low pH (3.5-3.7) for 30 minutes to one hour (Martins et al., 2020). Because the solution coming off of Protein A Chromatography is already at a pH of 3.5, performing VI immediately afterwards does not require additional buffers to be added. VI



after Protein A Chromatography is designed to clear endogenous viruses that may have been present in the fermenter. There are a few options for how to hold a solution for an hour at a low pH, but using a plug flow reactor (PFR) is optimal because it is continuous and has a narrower residence-time distribution (RTD) than an continuously stirred tank reactor (Fogler, 2006). A narrower RTD leads to less deviation from the targeted residence time of one hour.

$$E(t) = \begin{cases} 0 & t < \frac{\tau}{2} \\ \frac{\tau^2}{2t^3} & t \geq \frac{\tau}{2} \end{cases}$$

Equation 4.2.6. RTD for laminar plug flow reactor (Fogler, 2006).

Equation 4.2.6 shows that the RTD for any time less than half of that of the residence time is 0. Therefore, the minimum amount of time spent in the reactor is half of the residence time as shown in Equation 4.2.7. Since it is required for the solution to be held for at least 30 minutes, a residence time of 60 minutes was chosen for our process to guarantee the solution spends 30 minutes in the PFR.

$$t = \frac{L}{U_{max}} = \frac{L}{2U_{avg}} \left( \frac{\pi R^2}{\pi R^2} \right) = \frac{V}{2v_0} = \frac{\tau}{2}$$

Equation 4.2.7. Minimum time spent in laminar PFR (Fogler, 2006).

In addition to having to ensure a minimum inactivation time, holding mAbs at a low pH for too long can also cause undesired aggregation. High temperatures and high ionic strengths caused by the presence of salts may additionally increase the probability of aggregation. By conducting VI at room temperature in a sodium acetate buffer without the presence of salts, the maximum hold time for the VI plug flow reactor is 168 hours (Joshi et al., 2014). This results in a negligible amount of mAb aggregation, and full recovery can be assumed for our process.

With a flow rate of 9.26 mL/min and a desired residence time of one hour, the PFR was designed with a volume of 555.6 mL, a length of 7.07 m, and a diameter of 1 cm. This PFR will be coiled to conserve space in the plant.

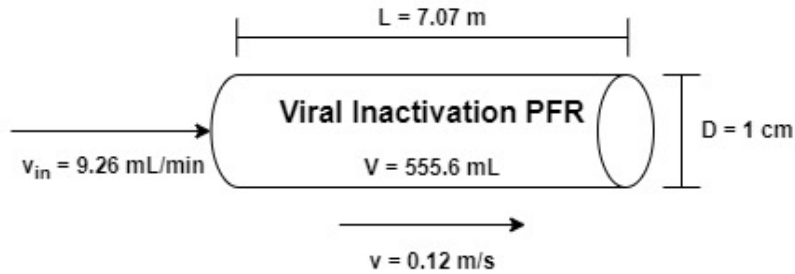

Figure 4.2.4. Viral Inactivation PFR design

Pressure drop in this pipe is important in determining the required pump power for operation. This was found through a calculation of the Reynolds number, which was found to be 1197, or within the laminar regime. Pressure drop could then be calculated based on the dimensions of the pipe using Equation 4.2.8. This was found to be 0.00272 bar of pressure loss across the length of pipe.

$$\Delta p = \frac{64}{Re} * \frac{L}{D} * \frac{\rho}{2} * v^2$$

Equation 4.2.8. Pressure drop across a circular pipe in laminar flow

#### 4.2.5 Diafiltration for Anion Exchange Chromatography

After VI and before entering anion exchange chromatography (AEX), the buffer in which adalimumab is suspended needs to be replaced. As mentioned above, if the antibody is in a solution of low pH for too long undesirable aggregation or product damage could occur (Joshi et al., 2014). Therefore, this process step will replace the low pH buffer with 25 mM sodium phosphate buffer with a pH of 7.5. A common technique for buffer replacement is diafiltration. This separation technique is similar to ultrafiltration in the fact that it uses permeable membrane

filters that separates components according to molecular size. However, there is no reduction in volume as a new solution is being fed as the original solution is being lost. For continuous diafiltration, 99.9% buffer exchange can be achieved with 7 diavolumes (Pall Laboratories, 2021). Therefore, since the stream exiting viral inactivation is flowing at a rate of 9.26 mL/min, 64.82 mL/min of 25 mM sodium phosphate buffer with a pH of 7.5 will be fed to the system. Assuming a rejection coefficient of 0.999, approximately 0.1% of adalimumab will flow through the membrane and be lost in the waste stream. The stream exiting VI will be at a concentration of 30.18 mg/mL, so the solution entering AEX will be at a concentration of 29.97 mg/mL at a flow rate of 9.26 mL/min as shown in Figure 4.2.5.

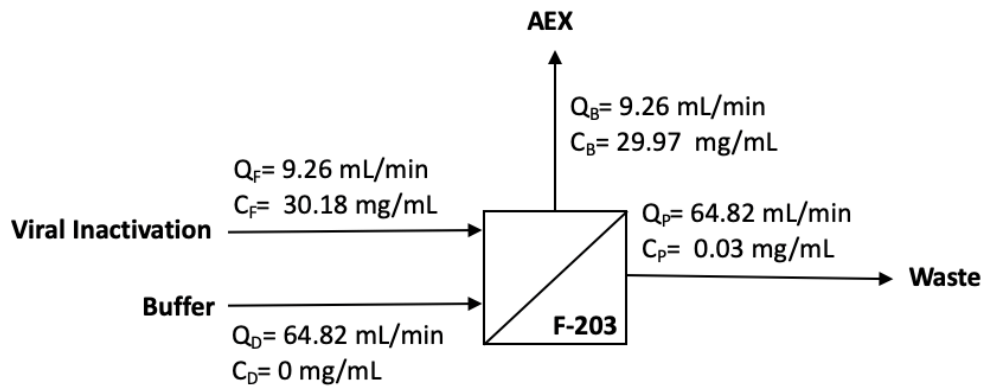

Figure 4.2.5. Block Flow Diagram with Balanced Streams for Diafiltration for Anion Exchange Chromatography

A similar diafiltration step will be performed before cation exchange chromatography (CEX) later on in the process. For both these stages, the ÄKTA Flux S tangential flow filtration system produced by Cytiva will be used. Like the ultrafiltration stage, this system is not single-use but was chosen for its ability to operate at low flow rates of 1 to 50 mL/min (Cytiva, 2022a). The system will be fitted with Cytiva’s compatible Start AXH ultrafiltration hollow fiber cartridges. The filters chosen have a NMWCO of 30 kDA and consist of 12 tubes that are 30 cm in length with a 0.05 cm diameter for a total membrane area of 50 cm<sup>2</sup>. The pressure drop

was found to be approximately 0.03 bar as calculated with Equations 4.2.1, 4.2.2, and 4.2.3. This is below the cartridge's maximum operating pressure of 3.4 bar, making these cartridges suitable for this diafiltration stage. This system will be cleaned in between each campaign with a sodium hydroxide solution.

#### **4.2.6 Anion Exchange Chromatography**

In AEX, a form of ion-exchange chromatography, the positively charged resin binds to negatively charged impurities, such as DNA or residual host cell proteins. In addition, this resin binds to virus fragments that remain in the solution, which makes AEX count towards one of the three required viral clearance methods (van Reis and Zydney, 2007). The charge of the mAb will be positive so that it flows past the resin to be collected. This charge is affected by the pH of the solution as well as a quality known as the isoelectric point (pI). At pH values below a protein's pI, the protein will be positively charged, and at pH values above a protein's pI, the protein will be negatively charged. We will operate at a pH of approximately 7.5 because our mAb has a pI in the range of 8.0 to 9.3, ensuring our mAb has a positive charge (Schreiber et al., 2020). In addition, the pI values of the impurities that are being captured at this stage have pI values between 2-5, leading to negative charges that attract to the resin. This pH will have been achieved through the previous diafiltration step which ensures that the mAb is in a 25 mM sodium phosphate buffer with a pH of 7.5. The buffers that will be used in this process are listed in Table 4.2.3.

Table 4.2.3.  
Salts and Buffers for Anion Exchange Chromatography

Phase	Flow Components
Load	25 mM sodium phosphate, pH 7.5 with mAb
Wash	25 mM sodium phosphate, pH 7.5
Strip	50 mM sodium phosphate, 1.0 M NaCl, pH 7.5
Clean	1.0 M NaOH
Regenerate	25 mM sodium phosphate, 2M NaCl pH 7.5
Equilibrate	25 mM sodium phosphate, pH 7.5

This AEX column will operate using the Capto Q Resin by Cytiva because it is designed for modern, large-scale manufacturers and utilizes a high dynamic binding capacity. This resin is made up of a rigid, high-flow agarose matrix modified with dextran surface extenders and a strong quaternary ammonium (Q) anion exchanger. The Capto Q Resin has an average particle size of around 90 micrometers, can withstand operating pressures of up to 3.31 bar, and functions in solutions with pH values of 2-12 (Cytiva, 2022c). Using a residence time of 2 minutes from Cytiva’s data and Figure 4.2.6, the DBC was calculated to be approximately 135 mg/mL.

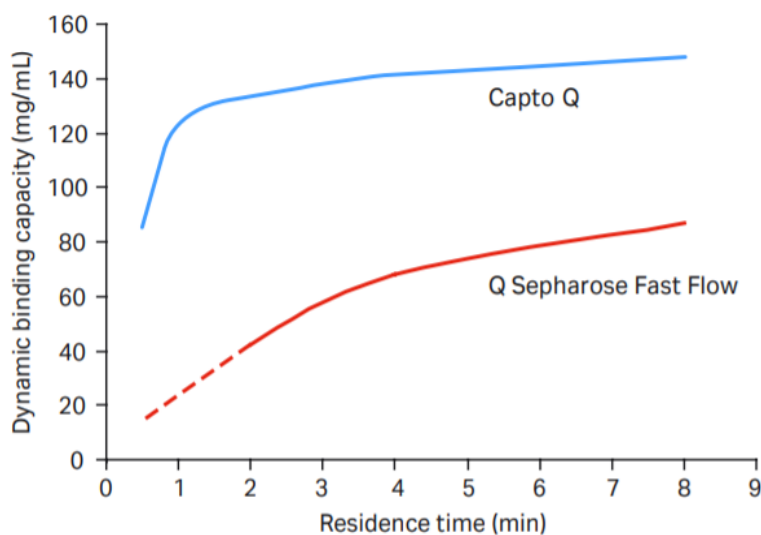

Figure 4.2.6. DBC<sub>10%</sub> for Cytiva’s Capto Q IEX Resin vs. Q Sepharose FF (Cytiva, 2020b)

We selected the HiScale 26/20 column by Cytiva with a 2.6 cm diameter as it is the same brand as used in Protein A but with a smaller diameter to account for the lower flow rate. Using the cross-sectional area of this column with the volumetric flow rate of feed entering the column, 9.26 mL/min, the required linear flow velocity is calculated to be 104.6 cm/hr, which is well within the upper limit for this resin (Cytiva, 2022c). With the linear flow velocity and residence time specified, the required bed height was determined to be 3.6 cm, which is achievable with the HiScale columns. This bed height gives a total column volume of 18.59 cm<sup>3</sup>. Finally, we can determine the pressure drop across the column to be 0.344 bar using the Carman-Kozeny equation (Equation 4.2.5), which is below the maximum allowable pressure drop (Cytiva, 2022d). The load volume was calculated using equation 4.2.4 to be 83.93 mL.

To ensure that this operation is continuous, two columns will run simultaneously with inlet and outlet concentrations of 29.97 and 29.67 mg/mL, respectively. This corresponds to a recovery of 99% for AEX (GE Healthcare, 2020a). One column will continuously load and collect while the other is washing, cleaning, and renewing for another cycle. There will also be a third column on hold in case of issues with the other three columns. This schedule can be seen in Table 4.2.4 below.

Table 4.2.4  
Scheduling for Anion Exchange Chromatography

Column 1	25 CV					5 CV	5 CV	5 CV	5 CV	5 CV
	Load/Collect					Wash	Strip	Clean	Regenerate	Equilibrate
Column 2	5 CV	5 CV	5 CV	5 CV	5 CV	25 CV				
	Wash	Strip	Clean	Regenerate	Equilibrate	Load/Collect				

This schedule corresponds to 129 minutes of loading and collecting, 25.8 minutes of washing, 25.8 minutes of stripping, 25.8 minutes of cleaning, 25.8 minutes of regeneration, and 25.8 minutes of equilibration per column in one cycle. This corresponds to a total cycle time of

258 minutes, thus mandating approximately 170 cycles over a 30 day campaign. The selected resin is assumed to be stable for more cycles than are required, so the columns will not need to be replaced until after the campaign. Columns will be disposed of following each campaign according to the methods described in section 4.6.2.

#### 4.2.7 Diafiltration for Cation Exchange Chromatography

Before CEX, the elution buffer left over from AEX must be replaced with the buffer required for CEX. As mentioned previously, a continuous diafiltration step will be employed. A 99.9% buffer replacement is possible in this process by adding seven times the volume of solution therefore 64.82 mL/min of 50 mM sodium acetate and sodium chloride buffer with a pH 5.0 will be added to the 9.26 mL/min stream leaving AEX. As with the diafiltration stage before AEX, a rejection coefficient of 0.999 is assumed. Therefore, approximately 0.1% of adalimumab will flow through the membrane and be lost in the waste stream. The stream entering filtration will have a concentration of 29.67 mg/mL and the stream leaving to CEX will have a concentration of 29.46 mg/mL as shown in Figure 4.2.7.

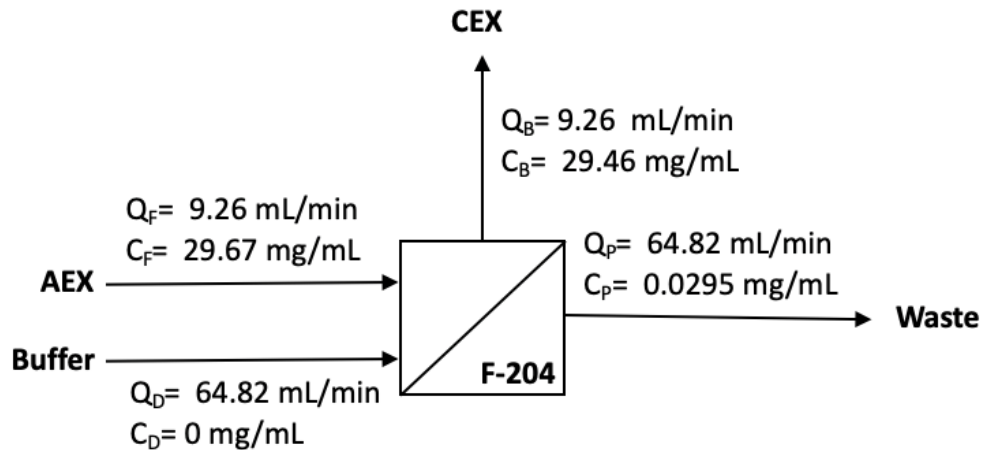

Figure 4.2.7. Block Flow Diagram with Balanced Streams for Diafiltration for Cation Exchange Chromatography

The module selected to perform this continuous diafiltration is the ÄKTA Flux S which would be equipped with Start AXH hollow fiber filter cartridges. The filters chosen have a NMWCO of 30 kDA and consist of 12 tubes that are 30 cm in length with a 0.05 cm diameter for a total membrane area of 50 cm<sup>2</sup>. When operated, this filter will have a pressure drop of 0.025 bar as calculated with Equations 4.2.1, 4.2.2, and 4.2.3. This is well below the maximum operating pressure drop of 3.4 bar. This system will be cleaned in between each campaign with a sodium hydroxide solution.

#### 4.2.8 Cation Exchange Chromatography

CEX is another form of ion-exchange chromatography which, as opposed to AEX, uses a negatively charged resin to bind to a positively charged antibody while allowing negatively charged contaminants, such as charge variants and aggregates, to pass through the column. CEX is used in this process as a polishing step to ensure that there are very few contaminants remaining. To ensure that the antibody is positively charged, the pH of the buffer solution that is being added in the previous diafiltration step will be 5.0 mM sodium acetate with 50 mM NaCl at a pH of 5.0. The buffers used in CEX are listed below in Table 4.2.5.

Table 4.2.5.  
Salts and Buffers for Cation Exchange Chromatography

Phase	Flow Components
Load	50 mM sodium acetate + 50 mM NaCl, pH 5.0 with mAb
Wash	50 mM sodium acetate + 50 mM NaCl, pH 5.0
Elute	Gradient of 50 mM sodium acetate + 240 mM NaCl, pH 5.0
Strip	50 mM sodium acetate + 500 mM NaCl, pH 5.0
Clean	1 M NaOH
Regenerate	50 mM sodium acetate + 2 mM NaCl, pH 5.0
Equilibrate	50 mM sodium acetate + 50 mM NaCl, pH 5.0



This CEX column will operate using the Capto S impAct resin from Cytiva because it is specifically designed for polishing of monoclonal antibodies such as in this step. This resin provides efficient purification of aggregates even at high load concentrations, and is adjustable to multiple flow rates and bed heights, allowing us to customize our columns to our specific needs. The Capto S impAct resin has approximately a 50 micrometer average particle diameter (Cytiva, 2020a). Using a residence time of approximately 5.4 minutes from Cytiva and Figure 4.2.8, the dynamic binding capacity was estimated to be about 90 mg/mL.

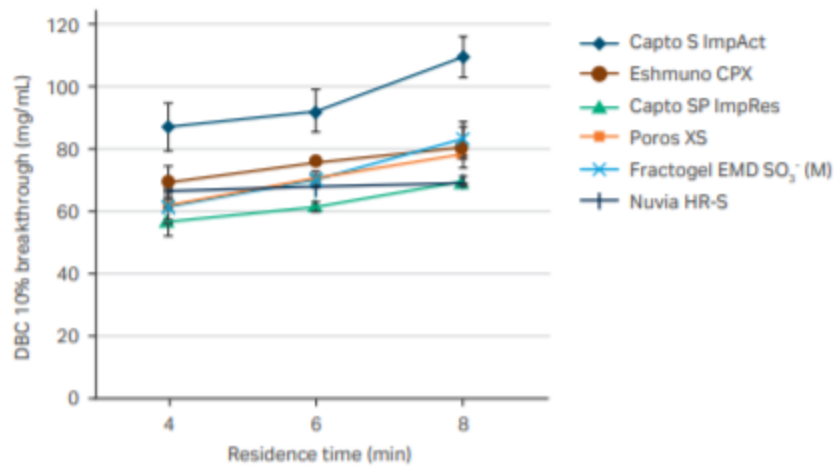

Figure 4.2.8. DBC<sub>10%</sub> of Capto S impAct versus Residence Time (GE Healthcare, 2015)

We again selected the HiScale 26/20 column by Cytiva with a 2.6 cm diameter for this process. Using the column's cross sectional area with the volumetric flow rate of supernatant entering the column, 9.26 mL/min, the required linear flow velocity is 104.6 cm/hr, which is well within the upper limit for this resin (Cytiva, 2020a). With the linear flow velocity and the residence time specified, the required bed height was determined to be 9 cm, which is achievable with the HiScale columns. This bed height gives a total column volume of 47.79 cm<sup>3</sup>. Finally, we can determine the pressure drop across the column using the Carman-Kozeny equation (Equation 4.2.5) and find a pressure drop of 2.76 bar, which is below the maximum allowable pressure drop (Cytiva, 2022d). The load volume was calculated using Equation 4.2.4 to be 146 mL.

To ensure that this operation is continuous, three columns will run simultaneously with inlet and outlet concentrations of 29.46 and 26.52 mg/mL, respectively. This corresponds to a recovery of 95% for CEX (GE Healthcare, 2020a). One column will continuously load, another will continuously elute and collect, while the last other is washing, cleaning, and renewing for another cycle. There will also be a fourth column on hold in case of issues with the other three columns. This schedule can be seen in Table 4.2.6 below.

Table 4.2.6.  
Scheduling for Cation Exchange Chromatography

Column 1	25 CV					5 CV	25 CV				5 CV	5 CV	5 CV	5 CV
	Load					Wash	Elute				Strip	Clean	Regenerate	Equilibrate
Column 2	25 CV	5 CV	5 CV	5 CV	5 CV	25 CV				5 CV	25 CV			
	Elute	Strip	Clean	Regenerate	Equilibrate	Load				Wash	Elute			
Column 3	5 CV	25 CV				5 CV	5 CV	5 CV	5 CV	25 CV				
	Wash	Elute				Strip	Clean	Regenerate	Equilibrate	Load				

This schedule corresponds to 129 minutes of loading, 25.8 minutes of washing, 129 minutes of elution, 25.8 minutes of stripping, 25.8 minutes of cleaning, 25.8 minutes of regeneration, and 25.8 minutes of equilibration per column for one cycle. This corresponds to a total cycle time of 258 minutes, thus mandating approximately 170 cycles over a 30 day campaign. The selected resin has been demonstrated to maintain performance through 300 cycles of operation, so the columns need not be replaced during the campaign (Cytiva, 2020a). Columns will be disposed of following each campaign according to the methods described in section 4.6.2.

#### 4.2.9 Viral Filtration

Viral filtration (VF) is the last of the three viral clearance methods required, and it is designed to clear adventitious viruses that may have been introduced in the downstream process.

Because adventitious viruses are less frequent, only a 6 log reduction value (LRV) is required (Liu et al., 2010). VF is a form of size based filtration that allows smaller proteins and buffers to pass while viruses cannot pass the pores of the filters.

Planova15N filters from Asahi Kasei were selected as they provide a 6.9 LRV to meet regulatory requirements and as they have an experimentally determined monoclonal antibody recovery rate greater than 95%. These filters have 15 nm pores and a surface area of 100 cm<sup>2</sup>. In order to handle the flow rate of 9.26 mL/min, two of the Planova15N filters will be run in parallel (*Planova™ 15N*, n.d.). The flow rate will remain constant, and the concentration will drop from 26.5 mg/mL to 25.19 mg/mL assuming 95% recovery to be conservative. The permeability factor was calculated to be  $1.02 \times 10^{-10} \frac{m^2 \cdot s}{kg}$  using equation 4.2.9 and data from a sales representative (Nixon, 2022). This permeability factor and equation 4.2.9 was then used to find the actual transmembrane pressure which is 0.76 bar. This filter will be housed in the Planova Single-Use Virus Filtration Controller (*Planova™ Single-Use*, (n.d.)).

$$permeability\ factor = \frac{V^*}{\Delta\Delta P}$$

Equation 4.2.9. Permeability Factor

#### 4.2.10 Final Ultrafiltration and Diafiltration

Before formulation and fill, the mAb solution must be concentrated, and the buffer must be exchanged. By concentrating the solution, the final product can be dispensed into smaller vials and less liquid will have to be removed during lyophilization. This will reduce storage requirements and save energy during lyophilization. Additionally, the buffer exchange is necessary in order to get adalimumab into WFI for final processing. To accomplish this, ultrafiltration and diafiltration are employed.

As mentioned previously, this project aims to implement single-use technologies wherever possible. Therefore, final ultrafiltration and diafiltration will differ from the previous filtration stages by implementing the ÄKTA Readyflux system produced by Cytiva. This system is advantageous compared to the ÄKTA Flux 6 and S systems because it is a single-use tangential flow filtration system that includes sensors pressure, conductivity, temperature, flow, and pH (Cytiva, 2022b). However, the feed to the system must be between 200 mL/min and 18000 mL/min, which is much greater than the flow rate of the stream exiting viral filtration. Therefore, the continuous 9.26 mL/min stream coming from the viral filtration will be captured and stored over six days before being processed, meaning the remaining processing steps will be run five times over each campaign. This design strategy is advantageous because it allows the implementation of single-use filtration systems and reduces the amount of times lyophilization will be performed, thus reducing the chance of human error. The ÄKTA Readyflux system will be fitted with a 30 kDA molecular weight cutoff, ReadytoProcess single-use hollow fiber filter cartridge from Cytiva (Cytiva, 2022e). These filters consist of 425 tubes that are 30 cm in length with a diameter of 0.05 cm, resulting in a total membrane surface area of 2000 cm<sup>2</sup>. The filter will be replaced at the end of each 30 day campaign.

At a flow rate of 9.26 mL/min, 80 L of solution will accumulate over the course of six days. This will then be processed at 400.2 mL/min over the course of 200 minutes. As with diafiltration, it is assumed that the rejection coefficient is 0.999 for adalimumab. Therefore, the ultrafiltration step will concentrate the antibody solution from 25.19 mg/mL to 50.35 mg/mL as shown in Figure 4.2.9. Because this is near the standard 50 mg/mL dose of Humira®, this was assumed to be a stable concentration that would not form aggregates. As a result of this concentration, the stream sent to diafiltration will be 200 mL/min, while 200.2 mL/min of waste

will be produced. Lastly, the pressure drop across this membrane was found to be 0.03 bar using Equations 4.2.1, 4.2.2, and 4.2.3, which is below the maximum operating pressure drop of 3.4 bar.

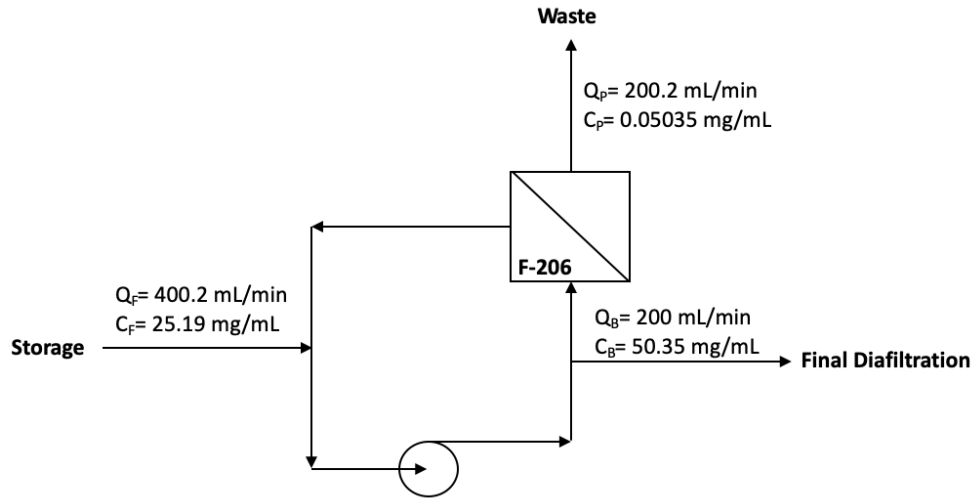

Figure 4.2.9. Block Flow Diagram with Balanced Streams for Final Ultrafiltration

After this concentration step, the buffer solution will be replaced using continuous diafiltration. In order to replace 99.9% of the original buffer solution, 1400 mL/min of WFI will be added to the 200 mL/min stream coming from the ultrafiltration while it is continuously filtered. With a 0.999 rejection coefficient, the resulting streams are 200 mL/min of solution containing 50 mg/mL of adalimumab heading to formulation and fill as well as a 1400 mL/min stream containing 0.05 mg/mL of adalimumab that is headed to waste as shown in Figure 4.2.10. The pressure drop across this membrane was found to be 0.015 bar using Equations 4.2.1, 4.2.2, and 4.2.3, which is below the maximum operating pressure drop of 3.4 bar.

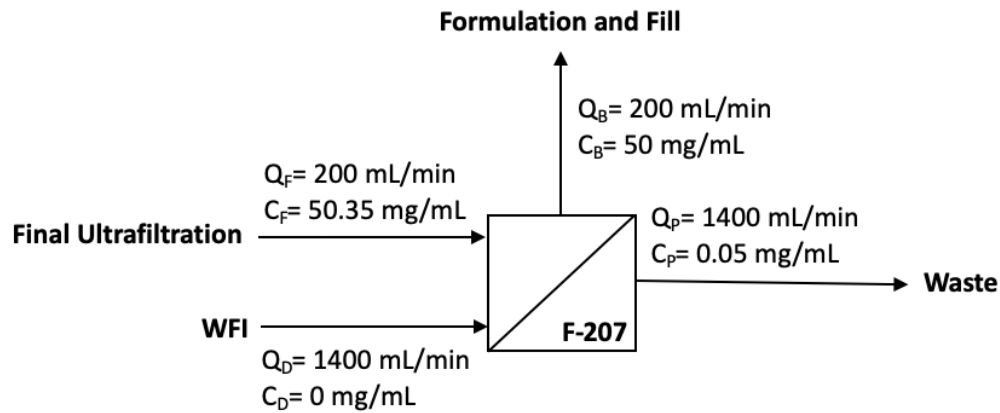

Figure 4.2.10. Block Flow Diagram with Balanced Streams for Final Diafiltration

#### 4.2.11 Formulation and Filling

The final formulation will be the standard Humira® dosage that an adult patient would take every other week as shown in Table 4.2.7. The additional ingredients shown in the table will be added to the stream exiting diafiltration to adjust pH before human injection and for product stability. 0.8 mL of the final solution will be dispensed into 2 mL vials and partially stoppered using the SA25 Aseptic Filling Workcell produced by Cytiva (Cytiva, 2022f). With 200 mL/min of solution exiting diafiltration for 200 minutes, 50000 vials will be filled after each of the five final ultrafiltration and diafiltration batches, resulting in 250000 vials or doses being filled per campaign.

Table 4.2.7  
Adalimumab Formulation

Ingredients	Mass (mg) in a Standard Dose	Mass (mg) Required per Campaign
Adalimumab	40	400
Sodium Chloride	4.93	49.3
Monobasic Sodium Phosphate Dihydrate	0.69	6.9
Dibasic Sodium Phosphate Dihydrate	1.22	12.2
Sodium Citrate	0.24	2.4
Citric Acid Monohydrate	1.04	10.4
Mannitol	9.6	96
Polysorbate 80	0.8	8
Sodium Hydroxide	Added to adjust pH to 5.2	-

#### 4.2.12 Lyophilization

The final step before shipping the product to pharmacies and hospitals will be lyophilization. This step removes water from the final solution through freeze drying in order to keep the drug stable longer and to prevent degradation. Aqueous antibodies being stored at 4 °C will stay stable for one month while lyophilized antibodies at -20 °C can stay stable for 3-5 years (Johnson, 2021). On top of that, lyophilized drugs can be shipped at room temperature for less than 5 days (*Shipping*, n.d.).

The concentration of adalimumab before beginning lyophilization is 50 mg/mL, and roughly 0.8 mL of water will be removed per dose. The Q144XSS from Millrock Technology will be used to lyophilize the product. It has 144 ft<sup>2</sup> of space and can accommodate the 50,000 2mL vials that need to be lyophilized for each run (*QUANTA*, n.d.). West Pharmaceutical Services will be used to source 250,000 rubber stoppers and 2 mL vials for each campaign (*13mm NovaPure*®, 2022; *Daikyo*, 2022). Like final ultrafiltration and diafiltration,

lyophilization will take place once every six days for a total of five times per campaign. By only running lyophilization five times, employees will not have to continuously load and unload the lyophilizer, reducing the chance for error. Lyophilization will typically take 24-48 hours depending on the amount of water present and the contents of the solution (Williams, 2016).

### 4.3 Ancillary Equipment

#### 4.3.1 Tank Design

Tanks will be used throughout the process to mix and hold solutions that will be added, such as the fermentation media and chromatography buffers. The holding tanks were designed to be filled to approximately 75% capacity and then drained to approximately 25% capacity. Once the holding tanks reach 25% capacity, they will be refilled to 75%. A CSTR will be used to make the media and buffer and refill the holding tanks. Media and buffer make-up will occur five times a campaign or every six days. This design is advantageous because human labor will only be required five times, and a batch will be well defined if a contamination were to be discovered. A holding tank will also be needed before final ultrafiltration and diafiltration as these final stages will also only be run five times per campaign. Tanks will also be available for waste storage. All tanks will be stainless steel with single-use bags and mixers. Table 4.3.1 details all the required tanks.

Table 4.3.1  
Tank Specifications for Holding, Mixing, and Waste Storage

Tank Name	Volume (L)	Contents	Purpose
TH-101	6000	Media	Holding Media for the bioreactor
TM-101	4000	Media	Mixing Media for the bioreactor
TH-201	160	50 mM sodium Acetate	Holding buffer for Protein A elution



TM-201	100	50 mM sodium Acetate	Mixing buffer for Protein A elution
TH-202	100	20 mM sodium phosphate, 0.5 M sodium chloride	Holding buffer for Protein A washing and equilibration
TM-202	75	20 mM sodium phosphate, 0.5 M sodium chloride	Mixing buffer for Protein A washing and equilibration
TH-203	100	1 M sodium hydroxide	Holding buffer for cleaning Protein A, AEX, and CEX
TM-203	75	1 M sodium hydroxide	Mixing buffer for cleaning Protein A, AEX, and CEX
TH-204	50	100 mM phosphoric acid	Holding buffer for regenerating Protein A
TM-204	30	100 mM phosphoric acid	Mixing buffer for regenerating Protein A
TH-205	1200	25 mM sodium phosphate	Holding buffer for diafiltration before AEX, AEX washing, and AEX equilibration
TM-205	800	25 mM sodium phosphate	Mixing buffer for diafiltration before AEX, AEX washing, and AEX equilibration
TH-206	30	50 mM sodium phosphate, 1 M sodium chloride	Holding buffer for stripping AEX
TM-206	20	50 mM sodium phosphate, 1 M sodium chloride	Mixing buffer for stripping AEX
TH-207	30	25 mM sodium phosphate, 2 M sodium chloride	Holding buffer for regenerating AEX
TM-207	20	25 mM sodium phosphate, 2 M sodium chloride	Mixing buffer for regenerating AEX
TH-208	1200	50 mM sodium acetate, 50 mM sodium chloride	Holding buffer for diafiltration before CEX, washing CEX, and equilibrating CEX
TM-208	800	50 mM sodium acetate, 50 mM sodium chloride	Mixing buffer for diafiltration before CEX, washing CEX, and equilibrating CEX
TH-209	160	50 mM sodium acetate, 240 mM sodium chloride	Holding buffer for eluting CEX

TM-209	100	50 mM sodium acetate, 240 mM sodium chloride	Mixing buffer for eluting CEX
TH-210	30	50 mM sodium acetate, 500 mM sodium chloride	Holding buffer for stripping CEX
TM-210	20	50 mM sodium acetate, 500 mM sodium chloride	Mixing buffer for stripping CEX
TH-211	30	50 mM sodium acetate, 2 M sodium chloride	Holding buffer for regenerating CEX
TM-211	20	50 mM sodium acetate, 2 M sodium chloride	Mixing buffer for regenerating CEX
TH-212	100	Adalimumab from Viral Filtration	Holding product stream to establish a higher flow rate before sending it through final ultra filtration
TW-101	5000	Waste from fermenter and tangential flow filtration	Waste storage
TW-201	6000	Waste from downstream processes	Waste storage
TW-202	6000	Waste from downstream processes	Waste storage

### 4.3.2 Pump Design

All flow rates will be controlled by pumps in the filtration and chromatography systems described above or by additional peristaltic pumps. Peristaltic pumps are often used for high purity applications such as pharmaceuticals as the material never comes into contact with the pump. Additionally, these pumps are able to operate at small flow rates such as the ones used in this process and are gentler on solutions (Dale, 2013). In total, a minimum of 27 pumps will be required with every pump having a spare. Therefore, 54 Masterflex L/S peristaltic pumps from Fisher Scientific will be purchased. These pumps can operate at flow rates of 0.36 to 3400

mL/min (Fisher Scientific, 2022b) It is assumed that the WFI system will supply WFI to the mixing tanks with the use of valves instead of pumps.

The power requirement for all pumps was calculated using Equation 4.3.1 where P is the power in Watts, V is the volumetric flow rate in m<sup>3</sup>/s, ΔP is the differential pressure in Pa, and η is the pump efficiency. It was assumed that all pumps have an efficiency of 70% with an electrical driver efficiency of 90%. For all streams without pressure differentials created by unit operations, it was estimated that 1.013 bar of differential pressure will be used to move from one unit operation to the next as the actual pressure could not be calculated with unknown pipe lengths. Additionally, it was assumed that there is a loss of 0.51 bar in pipes, heat exchangers, and all other unit operations due to frictional losses. Table 4.3.2 details all the pumps for all process streams, requiring a peristaltic pump. As seen in the table, the minimum total power requirement was found to be 185 W with 6.94 kWhr being required per campaign.

$$P = (V * \Delta P) / \eta$$

Equation 4.3.1. Pump Power Requirement

Table 4.3.2  
Power Requirements for Pumps

From	To	Flow Rate (mL/min)	Pressure (bar)	Minimum Power Required (W)	70% Shaft Efficiency (W)	90% Electrical Driver Efficiency (W)	Duration (hr)	Power Per Campaign (Whr)
<b>Media and Buffer Make-Up</b>								
TM-101	TH-101	3000.0	1.01	7.62	10.88	12.09	83.00	1007.00
TH-101	20 L Reactor, R-101	16.7	1.01	0.04	0.06	0.07	190.00	12.80
	50 L Reactor, R-102	2000.0	1.01	5.08	7.25	8.06	0.25	2.01
	500 L Reactor, R-103	2000.0	1.01	5.08	7.25	8.06	1.25	10.10
	500 L Reactor, R-103	2000.0	1.01	5.08	7.25	8.06	2.50	20.10

TH-101	500 L Reactor, R-103	353.0	1.01	0.90	1.28	1.42	720.00	1024.00
TM-201	TH-201	3000.0	1.01	7.62	10.88	12.09	2.22	26.90
TM-202	TH-202	3000.0	1.01	7.62	10.88	12.09	1.39	16.80
TM-203	TH-203	3000.0	1.01	7.62	10.88	12.09	1.53	18.50
TM-204	TH-204	3000.0	1.01	7.62	10.88	12.09	0.69	8.39
TM-205	TH-205	3000.0	1.01	7.62	10.88	12.09	16.7	201.00
TM-206	TH-206	3000.0	1.01	7.62	10.88	12.09	0.42	5.04
TM-207	TH-207	3000.0	1.01	7.62	10.88	12.09	0.42	5.04
TM-208	TH-208	3000.0	1.01	7.62	10.88	12.09	16.70	201.00
TM-209	TH-209	3000.0	1.01	7.62	10.88	12.09	2.22	26.90
TM-210	TH-210	3000.0	1.01	7.62	10.88	12.09	0.42	5.04
TM-211	TH-211	3000.0	1.01	7.62	10.88	12.09	0.03	0.35
<b>Upstream Process Streams</b>								
20 L Reactor, R-101	50 L Reactor, R-102	1000.0	1.01	2.54	3.63	4.03	0.333	1.34
50 L Reactor, R-102	500 L Reactor, R-103	1000.0	1.01	2.54	3.63	4.03	0.83	3.40
Air Filter, F-102	500 L Reactor, R-103	1000.0	0.01	0.87	1.25	1.39	720.00	998.00
500 L Reactor, R-103	TFF, F-101	548.0	0.41	0.84	1.20	1.34	720.00	962.00
TFF, F-101	Waste, TW-101	161.0	1.01	0.41	0.58	0.65	720.00	466.00
TFF, F-101	Recycle, R-103	196.0	1.01	0.50	0.71	0.79	720.00	568.00
TFF, F-101	Depth, F-201	192.0	2.07	0.83	1.18	1.31	720.00	943.00
<b>Downstream Process Streams</b>								
UF, F-202	HE-201	191.9	0.500	0.323	0.461	0.513	720	369.2
Protein A, C-201	VI, V-201	9.3	0.003	0.008	0.011	0.013	720	9.05
VF, F-205	TH-212	9.3	1.010	0.024	0.034	0.037	720	26.9
<b>Total Power (W) =</b>						<b>185</b>	<b>Total Power (kWhr) =</b>	<b>6.94</b>

### 4.3.3 Heat Exchanger Design

Between the upstream and downstream operations, a heat exchanger will be used to adjust the temperature of the stream. The upstream process operates at 33°C, a temperature that was chosen due the availability of published CHO kinetic data. However, operating at higher temperatures increases aggregation and degradation of monoclonal antibodies in low pH conditions such as the conditions used during Protein A chromatography (Joshi et al., 2014). Therefore, the monoclonal antibody solution coming out of the fermentation process must be cooled to room temperature before Protein A chromatography. In order to perform this operation, a steel counter current double pipe heat exchanger will be used after the depth filtration step with the warm stream containing the mAbs in the inside pipe and cooling material in the outer pipe..

The cooling stream was chosen to be a mixture of 50% ethylene glycol and water, as at low temperatures close to 0°C, water may begin to freeze and form crystals. However, ethylene glycol has a lower freezing point, ensuring that our cooling stream remains in the liquid phase. In addition, the temperature of the cooling stream was set to enter the heat exchanger at 5°C and leave at 7°C. This allowed us to calculate the  $\Delta T_{lm}$  as 19.998, as can be seen in equation 4.3.2.

$$\Delta T_{lm} = \frac{(T_{H,out} - T_{C,in}) - (T_{H,in} - T_{C,out})}{\ln\left(\frac{T_{H,out} - T_{C,in}}{T_{H,in} - T_{C,out}}\right)}$$

Equation 4.3.2.  $\Delta T_{lm}$  for a counter current double-pipe heat exchanger

We also could find the amount of heat required to leave the warm stream using the material balances and flow rate of 27.78 mL/min coming out of the depth filtration system (equation 4.3.3). This gave a Q of 24.9 J.

$$Q = m \times C_p \times \Delta T$$

Equation 4.3.3. Heat transfer required to change the temperature of a stream

In addition, as we determined the heat exchanger was made out of steel, we were able to estimate the overall heat transfer coefficient,  $U_o$ , as 285 W/m<sup>2</sup>K. This allowed us to calculate the overall heat transfer area of our heat exchanger using equation 4.3.4.

$$A = \frac{Q}{U_o \Delta T}$$

Equation 4.3.4. Heat transfer area required

From these equations, the area required was calculated to be 0.0044 m<sup>2</sup>, or 44 cm<sup>2</sup>. From a reapplication of equation 4.3.3 on the cooling stream, the mass of the cooling stream was found to be 0.0038 m/s or 214 mL/min.

#### 4.4 Water for Injection (WFI) System Design

All water used for the make-up of buffers, filtration, cleaning, and sterilization will be WFI as required by regulations. WFI is sterile, nonpyrogenic, distilled water with a pH of 5.0 to 7.0 and is used for products that require intravenous administration (*Sterile*, n.d.). According to USP standards, WFI must have less than 0.5 ppm organic carbon, less than 10 CFU/100 mL of bacteria, and 0.25 IU/mL endotoxin. WFI has been traditionally produced through distillation, but reverse osmosis (RO) has also been used to purify water more recently and is able to do so at a cheaper price according to Table 4.4.1 (*Water*, 2021). RO works by flowing pretreated water “tangentially across the membrane, producing transmembrane pressure that effectively rejects a water stream containing heavier ions and allows water containing fewer ions to pass through” (Wrampe, 2019). The purity of the water produced is determined by the concentration of the water entering the RO system. Reverse osmosis systems typically reject 85% to 98% of the total solids and have an 80% recovery rate of water (*Reverse Osmosis*, 2014; Wrampe, 2019). Because RO is operated at ambient temperature and pressure, it is important to run the product water through ultrafiltration so that there is no microbial contamination.

Table 4.4.1  
 Cost Comparison of Water for Injection Systems (*Water*, 2021)

<b>Typical Comparison of Energy Costs (Distillation vs. Membrane) per 1,000 gallons steam and power</b>	
4 Cell Multiple Effect Distillation	\$57.56
6 Cell Multiple Effect Distillation	\$43.26
Vapor Compression Distillation	\$24.84 - \$28.00
Membrane WFI	\$0.50 - \$4.60

*Note: Assumptions: steam: \$20.60/1000#; power: \$0.07/kw-hr*

As mentioned previously, this process implements single-use technologies as much as possible to reduce WFI requirements. Therefore, the only modules that will require cleaning and sterilization in between campaigns is the first ultrafiltration, viral inactivation, and diafiltration for AEX and CEX stages. To estimate the volume of WFI needed for cleaning and sterilization, it will be assumed that the cleaning and sterilization cycle for each component will last 90 minutes. It will also be assumed that each filtration module will be operated at its maximum flow rate while the viral inactivation stage will be operated at the minimum flow rate required to achieve turbulent flow. Therefore, the total volume of WFI required per campaign was found to be approximately 25000 L as shown in Table 4.4.2. This is equivalent to producing 578 mL/min. All WFI will be made on site.

Table 4.4.2  
 WFI Requirements per Campaign

<b>Module</b>	<b>Volume of Required WFI (L)</b>
Fermentation	15620
Protein A, C-201	880
AEX DF, F-203	2800
AEX, C-202	400
CEX DF, F-204	2800
CEX, C-203	800
Final DF, F-207	1400
Cleaning	248
<b>Total</b>	<b>24948</b>

To produce WFI for this process, the Medica® Pro-RE System by Evoqua will be used as it can produce over 1 L/min of purified water, more than exceeding our design requirements. It has a tank capacity of 50 L, and it is able to pump flow rates up to 4 L/min when needed for higher cleaning flow rates. It also meets USP standards by producing WFI with less than 0.03 ppm organic carbon (*Medica® systems*, 2017)

#### **4.5 Air Filtration System Design**

To ensure product sterility, the air supplied to the bioreactor must be purified before entering the system. For this design, the flow rate of air required to meet the oxygen demand of the cells was found to be of 0.002 vvm or 1000 mL/min. Therefore, the Opticap XL50 Capsule Filters with Millipore Express® SPG Hydrophobic Membrane will be used. These filters are optimal for single-use air filtration and can operate at low flow rates. They have a total filtration area of 19.6 cm<sup>2</sup> with an operating pressure of 0.014 bar at a flow rate of 1000 mL/min (Merck KGaA, 2021b).

#### **4.6 Disposal**

##### **4.6.1 Liquid Waste**

Liquid waste is generated in the purge stream from TFF in the perfusion process, each of the three chromatography steps, both diafiltrations between chromatography steps, and the final ultrafiltration and diafiltration. Waste from the bioreactor and the purge stream from TFF will be separated from the waste generated in downstream processes due to the presence of living CHO cells. The total amount of waste generated in a 30 day campaign from the upstream processes is listed in Table 5.3.1 and downstream waste is listed in Table 5.3.2. Waste tanks were designed to be filled up to 75% of its total capacity to prevent overflowing. Our selected waste disposal service



company, Eldredge Inc. in West Chester, PA, will be contracted to remove waste at the end of each campaign in a large tanker.

#### **4.6.2 Solid Waste**

Solid waste generated in our process includes all single use equipment, such as depth filters, TFF filters, bioreactor bags and impellers, and chromatography columns. It also includes cell bank storage vials and chromatography resins. This plant will generate approximately 175.6 kg of solid waste of this form per campaign, which will be identified as biohazardous material and placed into 55 gallon drums. Our selected waste disposal company, Eldredge Inc., will then retrieve these drums at the end of each campaign to be disposed of via incineration in an effort to lower environmental impact.

## **5. Final Design**

### **5.1 Upstream Process**

#### **5.1.1 Cell Line Acquisition and Media Selection**

This design is functional for any master cell bank that produces an adalimumab biosimilar. The cell bank will be distributed and stored in 4.5 mL vials, each at a concentration of  $50 \times 10^6$  cells/mL. The cells will be stored at  $-87^\circ\text{C}$  in a VIP Series Model MDF-U76VC-PA freezer, which will be stored within the same facility as the production process.

#### **5.1.2 Inoculum Train**

The scale-up will begin with one high density cell vial being thawed in a Thermo Fisher Precision GP 02 water bath and placed into 1 L of media at  $33^\circ\text{C}$ . This is allowed to grow in the ReadyToProcess WAVE 25 Rocker Reactor. Initially, this will have a cell density of 0.56 g/L and a glucose concentration of 6 g/L. Culture media will be added to the Wave bioreactor at 0.1 L/h for 190 hours, until it reaches 20 L. This final product will have a cell density of 8.5 g/L and a glucose concentration of 0.1 g/L, as well as a mAb concentration of 1.48 g/L.

Next, the contents of the 20L bag and 30 L of culture media with 9.94 g/L of glucose will be placed into a 50 L Xcellerex single use bioreactor for an additional batch stage. At the beginning of this batch stage, the bioreactor will have a cell, glucose, and mAb concentration of 3.4, 6.0, and 0.59 respectively. This batch is allowed to grow until glucose concentration reaches 2 g/L at  $33^\circ\text{C}$ , which will take 29 hours. At the end of this batch stage, the concentration of cells and mAb will be 9.14 and 1.59 g/L respectively.

The next batch step will be run in a 500L Xcellerex single use bioreactor. First, the contents of the previous bioreactor will be placed into the bioreactor as well as 150L of culture media containing 7.33 g/L of glucose. This 200 L batch stage will have beginning cell, glucose,

and mAb concentrations of 2.26, 6, and 0.40 g/L respectively. This is allowed to grow until the concentration of glucose reaches 2 g/L, which will take 36.7 hours. The final concentration of cells and mAb in this 200 L batch will be 8.03 and 1.4 g/L respectively. Then, in the same bioreactor, 300 L of culture media containing 8.67 g/L will be added. The bioreactor will now have new concentrations of 3.2 g/L of cells and 0.56 g/L of mAbs. This batch stage is grown until the glucose reaches a concentration of 2 g/L, this stage will take 30 hours. The final concentrations of cells and mAbs will be 8.96 g/L and 1.6 g/L respectively.

### **5.1.3 Perfusion Bioreactor**

The perfusion bioreactor selected for this design is a 500 L Xcellerex XDR single-use stirred tank bioreactor from Cytiva. An extra bioreactor of this type will be available in the event of complications with the primary vessel. The perfusion bioreactor will be operated for a campaign lasting 30 days, after which the single-use components—disposable bags and impellers—will be discarded.

This bioreactor has a tank diameter and liquid height of 0.750 meters, with approximately 0.375 meters of headspace. The vessel will contain a single impeller with a diameter of 0.263 meters, and the cross-sectional area of the tank is 0.442 m<sup>2</sup>. The impeller will mix the system at 200 RPM and 0.002 vvm of air will aerate the system. These conditions will produce a  $k_L a$  of 4.7 h<sup>-1</sup> that will support the oxygen uptake from cell growth. The total power required to operate the perfusion system is 49.8 W.

### **5.1.4 Tangential Flow Filtration and Recycle**

550 mL/min of the reactor effluent will be sent to tangential flow filtration, where 35% of this flow will pass through the filter as filtrate. Sartocon® Slice Disposable Hydrosart® Cassettes from Sartorius will be used as the tangential flow filters for this process. These filters

have a surface area of 0.1 m<sup>2</sup>, a pore size of 0.2 µm, and a CHO cell retention greater than 99%. The concentration of adalimumab will stay the same, aside from a 0.1% loss of antibodies in the filter. Out of the remaining 356 mL/min that does not leave as filtrate, 195 mL/min is recycled to the perfusion reactor and 161 mL/min is purged. The cell concentration of both of these streams is 13.6 g/L, and the antibody concentration remains at 1.56 g/L. The transmembrane pressure across tangential flow filtration is 0.082 bar.

## **5.2 Downstream**

### **5.2.1 Depth Filtration**

After TFF, depth filtration will be implemented to remove any large impurities such as lysed cell debris. For this stage, a single use Millistak+® Pod Disposable Depth A1HC Filter will be used. A stream flowing at 191.90 mL/min will go through the depth filtration. The filter is assumed to have a 99% recovery, causing the concentration of mAbs to go from 1.56 g/L to 1.54 g/L after filtration. This filter will be operated at the maximum operating pressure of 2.07 bar. The filter will be replaced after every campaign.

### **5.2.2 Ultrafiltration**

After the depth filtration, the stream will be taken through an ultrafiltration step to concentrate the mAb solution. The ÄKTA Flux 6 tangential flow filtration system, fitted with filters that have a nominal molecular weight cut off 30 kDa, will be used for this filtration. The stream going into ultrafiltration will be flowing at 191.90 mL/min and have a mAb concentration of 1.54 g/L. Two streams will leave this ultrafiltration stage, the waste stream and the bleed stream. The waste stream will be 164.12 mL/min and have a mAb concentration of 0.01 g/L, and be collected for disposal. The bleed stream will be 27.78 mL/min and have a mAb concentration of 10.59 g/L. The bleed stream is sent to the Protein A chromatography unit. This filter will have

a pressure drop of 0.393 bar across the filter. Due to this filter not being single use, it will be cleaned with a sodium hydroxide solution between each campaign.

### **5.2.3 Protein A Chromatography**

Protein A chromatography will be conducted using an ÄKTA pcc chromatography system from Cytiva; also from Cytiva, MabSelect Sure™ LX protein A resin will be used within HiScale 50/20 columns. The inner diameter of the columns is 5.0 centimeters, the bed height of the resin is 8.5 centimeters, and the operating pressure is set to 0.765 bar. The residence time is set to 6 minutes, which gives a dynamic binding capacity of 60 mg/mL. The column will be operated in bind and elute mode. The load and wash step flow rates are 27.78 mL/min and the elution, clean, regeneration, and equilibration step flow rates are 9.26 mL/min. The load product concentration is 10.59 mg/mL, and the eluent stream product concentration is 30.18 mg/mL. The product recovery in the protein A step is 95%. 30 CVs of supernatant from depth filtration are loaded onto the column in the loading step. 3 CVs of 20 mM sodium phosphate and 0.5 M NaCl at pH 7.0 compose the wash step. 10 CVs of 50 mM sodium acetate at pH 3.5 compose the elution step. 3 CVs of 1 M NaOH, 100 mM phosphoric acid at pH 2, and the same buffer as the wash step compose the cleaning, regeneration, and equilibration steps, respectively. At the designated flow rates, the total times for each step are 180 minutes for loading, 18 minutes for washing, 180 minutes for elution, 54 minutes for cleaning, 54 minutes for regeneration, and 54 minutes for equilibration for a single column per cycle. Three columns will be operated within the system simultaneously and staggered to maintain constant loading and a constant product stream.

#### **5.2.4 Viral Inactivation**

Following Protein A Chromatography, the product stream will be held at a pH of 3.5 to inactivate any endogenous viruses. The solution coming off of Protein A Chromatography is already at a pH of 3.5 so performing viral inactivation immediately afterwards does not require additional buffers. A custom spiraled stainless steel plug flow reactor will be used to ensure a nominal residence time of 60 minutes and a minimum residence time of 30 minutes. To accommodate the 9.26 mL/min flow rate entering viral inactivation, the plug flow reactor was designed with a volume of 555.6 mL, a length of 7.07 m, and a diameter of 1 cm. This plug flow reactor will be coiled to conserve space in the plant.

#### **5.2.5 Diafiltration for Anion Exchange Chromatography**

The 30.18 mg/mL solution leaving VI will enter diafiltration at a rate of 9.26 mL/min and drop to a concentration of 29.97 mg/mL. The remaining adalimumab will be lost in a waste stream at a concentration of 0.03 mg/mL. 64.82 mL/min of 25 mM sodium phosphate buffer with a pH of 7 will be added, resulting in a total of 2800 L of buffer needed per campaign.

The ÄKTA Flux S system will be used and equipped with Start AXH hollow fiber filter cartridges. The filters chosen have a NMWCO of 30 kDA and consist of 12 tubes that are 30 cm in length with a 0.05 cm diameter for a total membrane area of 50 cm<sup>2</sup>. This filter will have a pressure drop of 0.03 bar. This system will be cleaned in between each campaign with a sodium hydroxide solution.

#### **5.2.6 Anion Exchange Chromatography**

The Anion exchange process will use two HiScale 26/20 columns by Cytiva and an extra packed column will be held in addition to the two in use in case of failure. The columns will run at a pressure of 0.345 bar, a 2.6 cm diameter, and a packing height of 3.6 cm. These will be

operated with the Capto Q resin with a residence time of 2 minutes, and will operate at a linear velocity of 104.6 cm/hr.

The load, wash, and equilibration stages will utilize 25 mM sodium phosphate at a pH of 7.5. These steps require CVs of 25, 5, and 5, respectively. The strip phase will use 50 mM sodium phosphate and 1.0 M sodium phosphate, also at a pH of 7.5. The clean phase will utilize 1.0 M NaOH. The regeneration stage will utilize 35 mM sodium phosphate with 2M NaCl at a pH of 7.5. The strip, clean, and regeneration stages will all require 5 CVs. This corresponds to 129 minutes of loading and collecting, 25.6 minutes of washing, 25.6 minutes of stripping, 25.6 minutes of cleaning, 25.6 minutes of regeneration, and 25.6 minutes of equilibration per column in one cycle.

#### **5.2.7 Diafiltration for Cation Exchange Chromatography**

The 29.67 mg/mL solution leaving AEX will enter diafiltration at a rate of 9.26 mL/min and drop to a concentration of 29.46 mg/mL. The remaining adalimumab will be lost in a waste stream at a concentration of 0.03 mg/mL. 64.82 mL/min of 50 mM sodium acetate and sodium chloride buffer with a pH 5.0 will be added, resulting in a total of 2800 L of buffer needed per campaign.

The ÄKTA Flux S system will be used and equipped with Start AXH hollow fiber filter cartridges. The filters chosen have a NMWCO of 30 kDA and consist of 12 tubes that are 30 cm in length with a 0.05 cm diameter for a total membrane area of 50 cm<sup>2</sup>. This filter will have a pressure drop of 0.025 bar. This system will be cleaned in between each campaign with a sodium hydroxide solution.

### **5.2.8 Cation Exchange Chromatography**

For CEX, the HiScale 26/20 column by Cytiva with a 2.6 cm diameter will be used. The column will be packed to 9 cm with Capto S impAct resin, resulting in a total column volume of 47.79 cm<sup>3</sup>. This resin has approximately a 50 micrometer average particle diameter and a dynamic binding capacity of 90 mg/mL, assuming a 5.4 minute residence time. The load volume of this column is 146 mL, and the pressure drop will be 2.76 bar.

To ensure that this operation is continuous, three columns will run simultaneously with inlet and outlet concentrations of 29.46 and 26.52 mg/mL. One column will continuously load, another will continuously elute and collect, while the last other is washing, cleaning, and renewing for another cycle. There will also be a fourth column on hold in case of issues with the other three columns. 9.26 mL/min of solution will be loaded onto the column at a linear velocity of 104.6 cm/hr for 129 minutes. The column will then be washed with a 50 mM sodium acetate and sodium chloride solution for 25.8 minutes, eluted with a gradient of 50 mM sodium acetate and 240 mM sodium chloride solution for 129 minutes, stripped with a 50 mM sodium acetate and sodium chloride solution for 25.8 minutes, cleaned with a 1M sodium hydroxide solution for 25.8 minutes, regenerated with 50 mM sodium acetate and 2 mM sodium chloride for 25.8 minutes, and equilibrated with 50 mM sodium acetate and sodium chloride buffer for 25.8 minutes.

### **5.2.9 Viral Filtration**

9.26 mL/min of solution at a concentration of 26.50 mg/mL will undergo viral filtration and drop to a concentration of 25.19 mg/mL. Two Planova15N filters from Asahi Kasei with 15 nm pores and a surface area of 100 cm<sup>2</sup> will be used in parallel. The transmembrane pressure will be 0.76 bar. This filter will be housed in the Planova Single-Use Virus Filtration Controller.



### **5.2.10 Final Ultrafiltration and Diafiltration**

The 25.19 mg/mL solution exiting viral filtration at a rate of 9.26 mL/min will be captured and stored over six days before final processing, resulting in a total accumulation of 80 L of solution. This will enter ultrafiltration at 400.2 mL/min over the course of 200 minutes. The ultrafiltration step will concentrate the antibody solution from 25.19 mg/mL to 50.35 mg/mL. 200 mL/min of solution will be sent to diafiltration while 200.2 mL/min of waste will be produced at a concentration of 0.05 mg/mL. The concentration of the 200 mL/min stream entering diafiltration will then decrease from 50.35 mg/mL to 50 mg/mL. 1400 mL/min of WFI will be fed to the system resulting in a waste stream concentration of 0.05 mg/mL of adalimumab. This stage will require a total of 1400 L of WFI per campaign.

For both of these stages, the ÄKTA Readyflux system will be used and fitted with ReadytoProcess single-use hollow fiber filter cartridges by Cytiva. These filters have a molecular weight cutoff of 30 kDa and consist of 425 tubes that are 30 cm in length with a diameter of 0.05 cm, resulting in a total membrane surface area of 2000 cm<sup>2</sup>. The filter will be replaced at the end of each 30 day campaign. The pressure drop across the ultrafiltration and diafiltration membranes will be 0.03 and 0.015 bar, respectively.

### **5.2.11 Formulation and Filling**

The final formulation of a single dose of Humira contains 40 mg of adalimumab, 4.93 mg of sodium chloride, 0.69 mg of monobasic sodium phosphate dihydrate, 1.22 mg of dibasic sodium phosphate dihydrate, 0.24 mg sodium citrate, 1.04 mg citric acid monohydrate, 9.6 mg of mannitol, 0.8 mg of polysorbate 80, and sodium hydroxide to adjust the pH to 5.2 in 0.8 mL of WFI. 2 mL vials will be filled and partially stoppered using the SA25 Aseptic Filling Workcell produced by Cytiva with 0.8 mL of the final solution exiting diafiltration (Cytiva, 2022f). At a

flow rate of 200 mL/min for 200 minutes, 50,000 vials will be filled after each of the five final ultrafiltration and diafiltration batches, resulting in 250,000 vials or doses being filled per campaign.

### 5.2.12 Lyophilization

The 50,000 2 mL vials produced every six days in formulation and filling will be lyophilized in the Q144XSS from Millrock Technology with 144 ft<sup>2</sup>. West Pharmaceutical Services will be used to source 250,000 rubber stoppers and 2 mL vials for each campaign. The concentration of adalimumab before beginning lyophilization is 50 mg/mL, and roughly 0.8 mL of water will be removed per dose. The product will be lyophilized for 48 hours to remove all water.

## 5.3 Disposal

### 5.3.1 Liquid Waste

Tables 5.3.1 and 5.3.2 provide the total amount of liquid waste produced per campaign at each unit operation. Unit operations that do not produce liquid waste are omitted from this table. All waste is treated as outlined in section 4.6.1. Waste will be picked up by a chemical treatment company once per week, but the plant will have the capacity to store two weeks worth of waste.

Table 5.3.1  
Total Liquid Waste of Upstream Unit Operations per Campaign

Unit Operation	Total Waste to TW-101 (L per Campaign)
Fermentation	500
Tangential Flow Filtration	6940
<b>Total</b>	<b>7440</b>

Table 5.3.2  
Total Liquid Waste of Downstream Unit Operations per Campaign

Unit Operation	Total Waste to TW-201 (L per Campaign)
Ultrafiltration	7090
Protein A Chromatography	1680
Diafiltration before AEX	2800
Anion Exchange Chromatography	400
Diafiltration before CEX	2800
Cation Exchange Chromatography	800
Final Ultrafiltration	200
Final Diafiltration	1400
<b>Total Waste</b>	<b>17200</b>

### 5.3.2 Solid Waste

Table 5.3.3 provides the total amount of solid waste produced per campaign. Burns et al. (2021) provide estimations for the masses of vials, bags, TFF filters, depth filters, viral filters, and peristaltic tubing. Waste is reported by individual type or material. All solid waste is disposed of according to the methods described in section 4.6.2.

Table 5.3.3  
Total Solid Waste Produced per Campaign

Type of Waste	Mass/Unit	Units/Campaign	Total Mass/Campaign (g)
Cell Bank Vials	10.0 g	1	10.0
20 L Bags	2.5 kg	1	2500.0
50 L Bags	6.25 kg	1	6250.0
200 L Bags	25.0 kg	1	25000.0
500 L Bags	62.5 kg	1	62500.0
TFF Filters	0.25 kg	1	250.0
Depth Filters	0.5 kg	1	500.0
First UF Filters	7.3 g	1	7.3
Prepacked Protein A Columns	0.3 kg	4	1200.0
Prepacked AEX Columns	0.11 kg	3	330.0
Prepacked CEX Columns	0.14 kg	4	560.0
DF Filters	7.3 g	2	14.6
Viral Filters	0.29 kg	1	290.0
Final UF Filters	0.3 kg	1	300.0
Final DF Filters	0.3 kg	1	300.0
Peristaltic Tubing	25.2 g/ft	3000 ft	75600.0
<b>Total Waste (g)</b>			<b>175611.9</b>

## 5.4 Material & Energy Balances

### 5.4.1 Upstream Material & Energy Balances

Table 5.4.1  
Mass Balances for Upstream Batch Processes

Description	Material	Initial Mass (g)	Final Mass (g)
20 L Wave Reactor	Adalimumab	0	29.50
	Cells	0.563	170.00
	Glucose	6.000	1.94
50 L Reactor	Adalimumab	29.500	79.50
	Cells	170.000	457.00
	Glucose	300.000	100.00
200 L Reactor	Adalimumab	79.500	280.00
	Cells	457.000	1610.00
	Glucose	1200.000	400.00
500 L Reactor	Adalimumab	280.000	780.00
	Cells	1610.000	4480.00
	Glucose	3000.000	1000.00

Table 5.4.2  
Mass Balance for Upstream Continuous Processes

Description	From	To	Flow Rate	Flow Rate Units	Material	Concentration (g/L)				
Perfusion Reactor	TH-101	R-103	350	mL/min	Adalimumab	0				
					Cells	0				
					Glucose	6				
	F-102	R-103	0.002	vvm	Air	n/a				
					F-101	R-103	196	mL/min	Adalimumab	1.56
									Cells	13.6
	Glucose	1.93								
	R-103	F-101	548	mL/min	Adalimumab	1.56				
					Cells	8.96				
Glucose					1.93					
Tangential Flow Filtration	R-103	F-101	548	mL/min	Adalimumab	1.56				
					Cells	8.96				
					Glucose	1.93				
	F-101	TW-101	161	mL/min	Adalimumab	1.56				
					Cells	13.6				
					Glucose	1.93				
	F-101	F-201	192	mL/min	Adalimumab	1.56				
					Cell Debris	0.256				
					Glucose	1.93				

## 5.4.2 Downstream Material Balances

Table 5.4.3  
Mass Balance for Downstream Continuous Processes

Description	From	To	Flow Rate (mL/min)	Material	Concentration	Units
Depth Filtration	F-101	F-201	192	Adalimumab	1.56	g/L
				Cell Debris	0.256	g/L
	F-201	F-202	192	Adalimumab	1.54	g/L
Ultrafiltration	F-201	F-202	192	Adalimumab	1.54	g/L
	F-202	TW-201	164	Adalimumab	0.011	g/L
	F-202	HE-201	27.8	Adalimumab	10.6	g/L
Heat Exchanger	F-202	HE-201	27.8	Adalimumab	10.6	g/L
	HE-201	C-201	27.8	Adalimumab	10.6	g/L
Protein A	HE-201	C-201	27.8	Adalimumab	10.6	g/L
	TH-201	C-201	9.26	Sodium Acetate	50	mM
	C-201	V-201	9.26	Adalimumab	30.2	g/L
Viral Inactivation	C-201	V-201	9.26	Adalimumab	30.2	g/L
	V-201	F-203	9.26	Adalimumab	30.2	g/L
Diafiltration for AEX	V-201	F-203	9.26	Adalimumab	30.2	g/L
	TH-205	F-203	64.82	Sodium Phosphate	25	mM
	F-203	TW-201	64.82	Adalimumab	0.030	g/L
	F-203	C-202	9.26	Adalimumab	30.0	g/L
AEX	F-203	C-202	9.26	Adalimumab	30.0	g/L
	C-202	F-204	9.26	Adalimumab	29.7	g/L
Diafiltration for CEX	C-202	F-204	9.26	Adalimumab	29.7	g/L
	TH-208	F-204	64.82	Sodium Acetate	50	mM
				Sodium Chloride	50	mM
	F-204	TW-201	64.82	Adalimumab	0.029	g/L
F-204	C-203	9.26	Adalimumab	29.5	g/L	
CEX	F-204	C-203	9.26	Adalimumab	29.5	g/L
	TH-209	C-203	9.26	Sodium Acetate	50	mM
				Sodium Chloride	240	mM
	C-203	F-205	9.26	Adalimumab	26.5	g/L
Viral Filtration	C-203	F-205	9.26	Adalimumab	26.5	g/L
	F-205	TH-212	9.26	Adalimumab	25.19	g/L

Table 5.4.4  
Mass Balance for Downstream Semi-Continuous Processes

Description	From	To	Flow Rate (mL/min)	Material	Concentration	Units
Final Ultrafiltration	TH-212	F-206	400	Adalimumab	25.19	g/L
	F-206	TW-201	200	Adalimumab	0.050	g/L
	F-206	F-207	200	Adalimumab	50.4	g/L
Final Diafiltration	F-206	F-207	200	Adalimumab	50.4	g/L
	WFI	F-207	1400	Water	n/a	n/a
	F-207	TW-201	1400	Adalimumab	0.05	g/L
	F-207	Formulation and Fill	200	Adalimumab	50	g/L
Formulation and Fill	FF-201	Formulation and Fill	200	Adalimumab	50	g/L

## 5.5 Equipment Tables and Specifications

### 5.5.1 Upstream Equipment Table

Table 5.5.1  
Upstream Equipment Table

Unit	Unit Number	Model	Quantity	Pressure Drop (bar)	Size	Temperature (°C)
WCB Storage	FR-101	VIP ECO Model MDF-DU702VH-PA Freezer	1	-	730 L	-86
WCB Thawing	WB-101	Thermo Fisher Precision GP 02 water bath	2	-	2 L	25-33
Fermentation	R-101	WAVE 25 Rocker Reactor	2	-	25 L	33
	R-102	Xcellerex XDR 50	2	-	50 L	33
	R-103	Xcellerex XDR 500	3	-	500 L	33
TFF	F-101	Hydrosart® Microfiltration Cassettes	1	0.41	0.02 m <sup>2</sup>	33

## 5.5.2 Downstream Equipment Table

Table 5.5.2  
Downstream Equipment Table

Unit	Unit Number	Model	Quantity	Pressure Drop (bar)	Size
Depth Filtration	F-201	Millistak+® Pod Disposable Depth A1HC Filter	1	2.07	A = 270 cm <sup>2</sup>
Ultrafiltration	F-202	ÄKTA Flux 6	2	0.393	-
		Start AXM UFP-30-C-2U cartridge	1		A = 50 cm <sup>2</sup>
Protein A Chromatography	C-201	ÄKTA pcc	2	0.77	D = 5 cm, h = 8.5 cm
		HiScale 50/20 Prepacked Columns	4		
Viral Inactivation	V-201	Custom Plug Flow Reactor	1	0.003	D = 1 cm, L = 7.07 m
Diafiltration	F-203	ÄKTA Flux S tangential flow filtration system	2	0.03	-
		Start AXH UFP-30-C-2U cartridge	1		A = 50 cm <sup>2</sup>
Anion Exchange Chromatography	C-202	ÄKTA pcc	1	0.34	-
		HiScale 26/20 Prepacked Columns	3		D = 2.6 cm, h = 3.6 cm
Diafiltration	F-204	ÄKTA Flux S tangential flow filtration system	1	0.025	-
		Start AXH UFP-30-C-2U cartridge	1		A = 50 cm <sup>2</sup>
Cation Exchange Chromatography	C-203	ÄKTA pcc	1	2.76	-
		HiScale 26/20 Prepacked Columns	4		D = 2.6 cm, h = 9 cm
Viral Filtration	F-205	Planova Single-Use Virus Filtration Controller	2	0.76	-
		Planova 15N	2		A = 100 cm <sup>2</sup>
Final Ultrafiltration	F-206	AKTA ReadyFlux Tangential Flow Filtration System	2	0.03	-
		RTPUFP-30-C-5S	1		A = 2000 cm <sup>2</sup>
Final Diafiltration	F-207	AKTA ReadyFlux Tangential Flow Filtration System	1	0.015	-
		RTPUFP-30-C-5S	1		A = 2000 cm <sup>2</sup>
Formulation and Fill	FF-201	SA25 Aseptic Filling Workcell	1	-	-
Lyophilization	LY-201	Q144XSS from Millrock Technology	1	-	-

### 5.5.3 Ancillary Equipment Table

Table 5.5.3  
Ancillary Equipment Table

Unit	Unit Number	Model	Quantity
Autoclave	-	Custom Autoclave	1
Heat Exchanger	HE-201	Custom Heat Exchanger	1
Peristaltic Pumps	P1 to P27	Masterflex™ L/S™ Variable-Speed Console Drive with Pump Head Bundles	54
Mixers for tanks under 3000 L	-	1/3 HP Electric Direct Drive Economy Clamp Mount	11
Mixers for tanks above 3000 L	-	Raiden Standard 2 HP Plate Mount Top Entry Mixer	1
20 L Tank	TM-206, 207, 210, 211	Custom Stainless Steel Tank	4
30 L Tank	TH-206, 207, 210, 211 TM-204	Custom Stainless Steel Tank	5
50 L Tank	TH-204	Custom Stainless Steel Tank	1
75 L Tank	TM-202, 203	Custom Stainless Steel Tank	2
100 L Tank	TH-202, 203, 212 TM-201, 209	Custom Stainless Steel Tank	5
160 L Tank	TH-201, 209	Custom Stainless Steel Tank	2
800 L Tank	TM-205, 208	Custom Stainless Steel Tank	2
1200 L Tank	TH-205, 208	Custom Stainless Steel Tank	2
4000 L Tank	TM-101	Custom Stainless Steel Tank	1
5000 L Tank	TW-101	Custom Stainless Steel Tank	1
6000 L Tank	TH-101 TW-201, 202	Custom Stainless Steel Tank	3
WFI System	-	Medica® Pro-RE	1

### 5.6 Production Schedule

As mentioned previously, this process will be run as a series of six 30 day perfusion campaigns. The schedule for a single campaign is shown in Figure 5.6.1. As seen in the figure,



there will be a three day offset between the inoculum seed train and the start of perfusion. This is to allow time to prepare the downstream equipment for processing as some cleaning and sterilization will be required and as membranes and resins will have to be replaced. With the 12 day seed train and 30 day perfusion campaign, processing will occur for a total of 42 days, or 6 weeks. Figure 5.6.2 shows the yearly production schedule for this process. The purple squares represent weeks in which the inoculum train is occurring while blue squares represent the perfusion campaign. For all campaigns except the first one, the inoculum train will begin while the previous campaign is in operation. The completion of the 6 campaigns will take 7 months with two weeks allowed for shut-down. These extra two weeks gives the facility some flexibility to accommodate any process excursions. For the remainder of the year, the facility can be used to produce another product. However, if demand for this product grows, then there will also be the ability to run more campaigns.

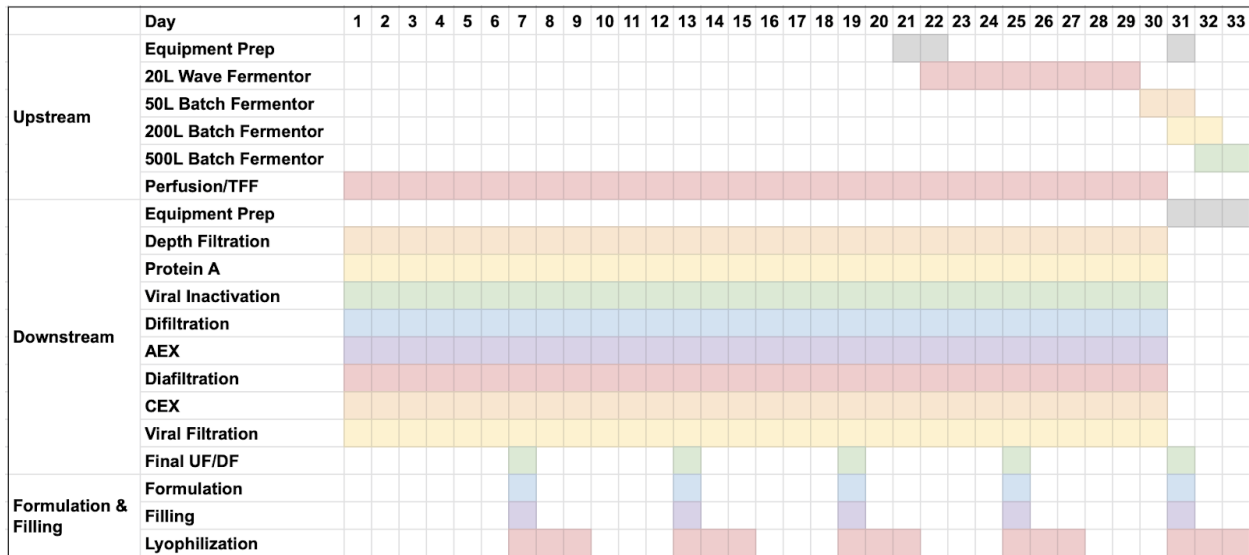

Figure 5.6.1. Campaign Production Schedule

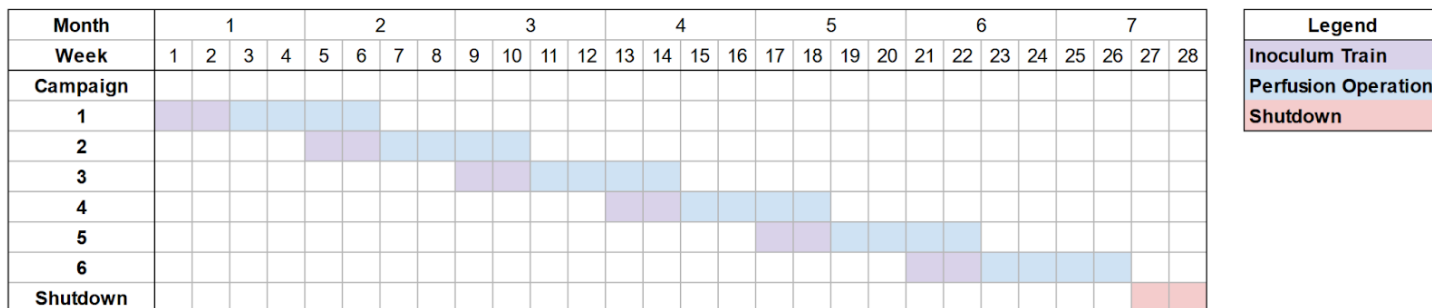

Figure 5.6.2. Yearly Production Schedule

## 5.7 Plant Location

This manufacturing site will be located in West Chester, Pennsylvania, which is approximately 35 miles west of Philadelphia. As a hub for many pharmaceutical companies such as Janssen and GSK, the suburban regions of Philadelphia offer an attractive environment for professionals in the industry. Many young professionals from colleges such as the University of Pennsylvania and the University of Delaware will also likely be available to take the jobs needed to operate our facility. Lastly, due to the smaller scale of our manufacturing process, our facility could possibly be implemented in already existing office space in the region, or a smaller plot of land could be obtained and the facility could be constructed from scratch.

## 5.8 Process Economics

### 5.8.1 Plant Capital Costing

Capital costs are one time expenses that must be incurred before operations can begin. Examples of capital costs include main equipment, piping, and land. Table 5.8.1 took information from Peters and Timmerhaus (1991) on a range of budget allocations for capital costs. We then based our own values for our capital cost budget based on the previous years' capstone projects and our knowledge of the pharmaceutical industry (Abt et al., 2020; Burns et al., 2021). For example, Peters and Timmerhaus recommend spending anywhere between 3%

and 20% of the capital budget on piping, but we chose to allocate only 4% because the flow rates for our process are small and much of our piping is disposable.

Equation 5.8.1 was used to estimate the total capital costs based on a Lang Factor of 4.74 which represents a fluid processing plant (Turton et al., 2012). This determined that 21% of our capital costs would be spent on equipment. With \$13.5 million spent on purchased equipment (Tables 5.8.2 and 5.8.3) and an additional \$1 cost of validation, the total capital costs sum up to \$65.5 billion.

$$\text{Capital Cost} = (\text{Lang Factor}) * (\text{Sum of Purchased Costs of All Major Equipment})$$

Equation 5.8.1. Estimating Capital Costs Based on Major Equipment Costs (Turton et al., 2012).

Table 5.8.1  
Capital Cost Budget Allocation (Peters & Timmerhaus, 1991)

Component	Recommended Range (%)	Our Percentages	Cost
<b>Direct Costs</b>			
Purchased Equipment	15-40	21	\$13,547,762
Purchased Equipment Installation	6-14	10	\$6,451,315
Instrumentation and Controls (installed)	2-8	6	\$3,870,789
Piping (installed)	3-20	4	\$2,580,526
Electrical (installed)	2-10	4	\$2,580,526
Buildings (including services)	3-18	11	\$7,096,447
Yard Improvements	2-5	1	\$645,132
Service Facilities (installed)	8-20	10	\$6,451,315
Land	1-2	1	\$645,132
<b>Indirect Costs</b>			
Engineering and Supervision	4-21	15	\$9,676,973
Construction Expense	4-16	5	\$3,225,658
Contractor's Fee	2-6	2	\$1,290,263
Contingency	5-15	10	\$6,451,315
<b>Total Fixed Capital Investment</b>			\$64,513,152
<b>Total with Validation</b>			<b>\$65,513,152</b>

Main equipment costs were \$11.9 million (Table 5.8.2) and ancillary equipment costs were \$1.7 million (Table 5.8.3). In total, \$13.5 million worth of capital was spent on purchased equipment. Prices from the purchased equipment were found from what was listed on the website, quotes from sales representatives, estimates from previous projects, or custom made estimates.

Table 5.8.2.  
Main Equipment Costs

Unit Operation	Model	Quantity Purchased	Purchased Equipment Cost	Total Cost
WCB Storage	VIP ECO Model MDF-DU702VH-PA Freezer	1	\$13,662	\$13,662
WCB Thawing	Thermo Fisher Precision GP 02 water bath	2	\$1,000	\$2,000
Fermentation	WAVE 25 Rocker Reactor	2	\$2,800	\$5,600
	Xcellerex XDR 50	2	\$6,670	\$53,400
	Xcellerex XDR 500	3	\$15,700	\$188,700
Ultrafiltration	ÄKTA Flux 6	2	\$70,000	\$140,000
Protein A Chromatography	ÄKTA pcc	1	\$250,000	\$250,000
Viral Inactivation	Custom Plug Flow Reactor	1	\$7,300	\$7,300
Diafiltration	ÄKTA Flux S tangential flow filtration system	2	\$40,000	\$80,000
Anion Exchange Chromatography	ÄKTA pcc	2	\$250,000	\$500,000
Diafiltration	ÄKTA Flux S tangential flow filtration system	1	\$40,000	\$40,000
Cation Exchange Chromatography	ÄKTA pcc	1	\$250,000	\$250,000
Viral Filtration	Planova Single-Use Virus Filtration Controller	2	\$40,000	\$80,000
Final Ultrafiltration	AKTA ReadyFlux Tangential Flow Filtration System	2	\$250,000	\$500,000
Final Diafiltration	AKTA ReadyFlux Tangential Flow Filtration System	1	\$250,000	\$250,000
Filling	SA25 Aseptic Filling Workcell	1	\$7,000,000	\$7,000,000
Lyophilizer	Q144XSS from Millrock Technology	1	\$2,500,000	\$2,500,000
<b>Total</b>				<b>\$11,860,662</b>

Table 5.8.3  
Ancillary Equipment Costs

Unit Operation	Model	Quantity	Cost Per Unit	Total Cost
Autoclave	Custom Autoclave	1	\$376,000	\$376,000
Heat Exchanger	Custom Heat Exchanger	1	\$28,300	\$28,300
Peristaltic Pumps	Masterflex™ L/S™ Variable-Speed Console Drive with Pump Head Bundles	54	\$2,250	\$121,500
Mixers for tanks under 3000 L	1/3 HP Electric Direct Drive Economy Clamp Mount	11	\$800	\$8,800
Mixers for tanks above 3000 L	Raiden Standard 2 HP Plate Mount Top Entry Mixer	1	\$5,000	\$5,000
20 L Tank	Custom Stainless Steel Tank	4	\$600	\$2,400
30 L Tank	Custom Stainless Steel Tank	5	\$900	\$4,500
50 L Tank	Custom Stainless Steel Tank	1	\$1,500	\$1,500
75 L Tank	Custom Stainless Steel Tank	2	\$2,250	\$4,500
100 L Tank	Custom Stainless Steel Tank	5	\$3,000	\$15,000
160 L Tank	Custom Stainless Steel Tank	2	\$4,800	\$9,600
800 L Tank	Custom Stainless Steel Tank	2	\$24,000	\$48,000
1200 L Tank	Custom Stainless Steel Tank	2	\$36,000	\$72,000
4000 L Tank	Custom Stainless Steel Tank	1	\$120,000	\$120,000
5000 L Tank	Custom Stainless Steel Tank	1	\$150,000	\$150,000
6000 L Tank	Custom Stainless Steel Tank	3	\$180,000	\$540,000
WFI System	Medica® Pro-RE	1	\$180,000	\$180,000
<b>Total</b>				<b>\$1,687,100</b>

### 5.8.2 FDA Approval and Validation Costs

Because our facility is designed to produce a biosimilar that has already received FDA approval, capital costs for clinical development need not be considered. However, there are still requirements from the FDA for process validation that our facility would need to go through to ensure its operability within the regulations of the agency. The FDA outlines the validation process in three stages: process design, process qualification, and continued process verification (U.S. Food and Drug Administration, 2011). The first stage, process design, dictates that knowledge and understanding of the intended process should be accumulated and documented,

followed by the establishment of process control strategies (U.S. Food and Drug Administration, 2011). Both of these tasks are performed in accordance with the relevant guidance documents.

The process qualification stage contains four steps. First, the buildings, equipment, and utility systems must be designed and qualified with proper testing and reporting of the conclusions. The second step of process qualification is process performance qualification (PPQ). The FDA defines a successful PPQ as one that “will confirm the process design and demonstrate that the commercial manufacturing process performs as expected” (2011). This step combines the efforts of the first stage and the second step of the second stage to show that the process is able to produce a substance as it is intended. The third step is the PPQ protocol, a document that defines the specific operating conditions, methods of data collection, performance testing strategies and their corresponding acceptance criteria, and risk assessment strategies among other technical details of the process (U.S. Food and Drug Administration, 2011). The final step of the process qualification stage is the preparation of a report for the PPQ protocol that must be delivered and approved by the relevant departments of the FDA before said protocol may begin operation (U.S. Food and Drug Administration, 2011). Once these steps are finished, the initial process validation is complete and commercial manufacturing may begin.

The final stage of process validation is continuous process verification. The FDA mandates that manufacturers must maintain data collection and reporting so as to renew the initial PPQ protocol verification on a yearly basis, with a collective report coming in no later than 60 days after the anniversary of the initial approval (U.S. Food and Drug Administration). For our facility, we have estimated that the initial process validation (i.e., stages one and two) shall be completed in 18 months, and the first annual continued process verification report will be filed in 30 months. We have also estimated that the capital investment for these validations

will accumulate to approximately \$1 million per year, which has been factored into the economic analysis (Abt et al., 2020).

### 5.8.3 Operating Expenses

In addition to the fixed capital investment and the FDA approval and validation costs to start the plant, there will be annual operating costs associated with production. Table 5.8.4 shows all the factors that were included in the annual operating costs. As shown below, these costs were divided into direct costs, fixed costs, and general costs. In order to calculate each of these costs, the fixed capital investment (FCI), cost of raw materials ( $C_{RM}$ ), cost of waste treatment ( $C_{WT}$ ), cost of utilities ( $C_{UT}$ ), and cost of operating labor ( $C_{OL}$ ) must be known. As shown in section 5.8.1, the FCI for this process is \$65,513,152. The  $C_{RM}$ ,  $C_{WT}$ ,  $C_{UT}$ , and  $C_{OL}$  are explained in the subsequent paragraphs. All other costs were then derived from these values using the methodology explained in Turton. As such, the cost of manufacturing (COM) was calculated to be \$42,975,756 using Equation 5.8.2 while all other costs were calculated using the equations shown in Table 5.8.4 (Turton et al., 2012). Using these values, the total annual operating cost was determined to be \$44,290,428.

$$COM = 0.280 * FCI + 2.73 * C_{OL} + 1.23(C_{RM} + C_{WT} + C_{UT})$$

Equation 5.8.2. The Cost of Manufacturing (Turton et al., 2012)

Table 5.8.4  
Annual Operating Cost for Adalimumab Production (Turton et al., 2012)

<b>Annual Operating Cost</b>		
<b>Direct Cost</b>	<b>Nomenclature</b>	<b>Cost</b>
Raw materials	C_RM	\$11,428,060
Waste treatment	C_WT	\$96,884
Utilities	C_UT	\$3,008
Operating labor	C_OL	\$3,828,825
Direct and supervisory and clerical labor	0.18*C_OL	\$689,189
Maintenance and repairs	0.06*FCI	\$3,930,789
Operating supplies	0.009*FCI	\$589,618
Laboratory charges	0.15*C_OL	\$574,324
Patents and Royalties	0.03*COM	\$1,289,273
<b>Fixed Costs</b>		
Depreciation	0.1*FCI	\$6,551,315
Local taxes and insurance	0.032*FCI	\$2,096,421
Plant overhead costs	0.708*C_OL + 0.036*FCI	\$5,069,282
<b>General Cost</b>		
Administration	0.177*C_OL+0.009*FCI	\$1,267,320
Distribution and selling costs	0.11*COM	\$4,727,333
Research and development	0.05*COM	\$2,148,788
<b>Total operating cost</b>		<b>\$44,290,428</b>

The cost of raw materials included constant flow and solid materials that were purchased each campaign in order to maintain operation. Constant flow costs are shown in Table 5.8.5 and include the costs of media, buffers, and formulation ingredients used over the course of a year. Water for injection was not included as a constant flow cost, rather it was treated as a utility. Constant flow costs were obtained from the prices on vendors' websites. Table 5.8.6 displays the solid materials which are designed to be replaced in between campaigns. It is important to note that for this process, chromatography columns are disposable and they are treated as a raw material rather than a capital cost. Estimates for solid costs came from the prices on vendor's



websites or quotes from sales representatives. The total cost for raw materials was found to be \$11,428,060 per year.

Table 5.8.5  
Constant Flow Costs Per Year of Processing

Unit Op	Material	Quantity per Year	Units	Price per Unit	Cost per Year
Fermentation	Media	3273	kg	\$1,135	\$3,713,186
	L-glutamine	109.6	kg	\$312	\$34,186
Protein A	Sodium Phosphate	4.72	kg	\$47	\$221
	Sodium Chloride	42.1	kg	\$3	\$126
	Sodium Acetate	2.95	kg	\$93	\$273
	Sodium Hydroxide	28.8	kg	\$11	\$322
	Phosphoric Acid (1 M)	72	L	\$40	\$2,844
Diafiltration before AEX	Sodium Phosphate	68.9	kg	\$47	\$3,222
AEX	Sodium Phosphate	9.84	kg	\$47	\$460
	Sodium Chloride	84.2	kg	\$3	\$252
	Sodium Hydroxide	19.2	kg	\$11	\$215
Diafiltration before CEX	Sodium Acetate	68.9	kg	\$93	\$6,381
	Sodium Chloride	49.09	kg	\$3	\$147
CEX	Sodium Acetate	17.72	kg	\$93	\$1,641
	Sodium Chloride	106.6	kg	\$3	\$320
	Sodium Hydroxide	19.2	kg	\$11	\$215
Formulation and Fill	Sodium Chloride	7.40	kg	\$3	\$22
	Monobasic Sodium Phosphate Dihydrate	1.04	kg	\$201	\$208
	Dibasic Sodium Phosphate Dihydrate	1.83	kg	\$158	\$289
	Sodium Citrate	0.36	kg	\$387,000	\$139,320
	Citric Acid Monohydrate	1.56	kg	\$17	\$27
	Mannitol	14.4	kg	\$106	\$1,532
	Polysorbate 80	1.2	kg	\$123	\$148
Cleaning	Sodium Hydroxide	59.52	kg	\$11	\$665
<b>Total</b>					<b>\$3,906,224</b>

Table 5.8.6  
Solid Raw Material Costs

Unit Operation	Material	Product	Quantity per Campaign	Cost Per Unit	Cost per Year
Tangential Flow Filtration	Filter	Sartocon® Slice Disposable Hydrosart® Cassette	1	\$653	\$3,918
Air Filtration	Filter	Gamma Phobic Opticap® XL 50 Express SPG 0.2 HB/HB	1	\$34	\$206
Depth Filtration	Filter	Millistak+® Pod Disposable Depth A1HC Filter	1	\$224	\$1,341
Ultrafiltration	Filter	Start AXM UFP-30-C-2U cartridge	1	\$298	\$1,788
Protein A	Column & Resin	HiScale 50/20 Prepacked Columns	4	\$6,900	\$165,600
Diafiltration before AEX	Filter	Start AXM UFP-30-C-2U cartridge	1	\$298	\$1,788
Anion Exchange Chromatography	Column & Resin	HiScale 26/20 Prepacked Columns	3	\$2,100	\$37,800
Diafiltration before CEX	Filter	Start AXM UFP-30-C-2U cartridge	1	\$298	\$1,788
Cation Exchange Chromatography	Column & Resin	HiScale 26/20 Prepacked Columns	4	\$2,400	\$57,600
Viral Filtration	Filter	Planova15N	2	\$500	\$6,000
Final Ultrafiltration	Filter	RTPUFP-30-C-5S	1	\$2,179	\$13,074
Final Diafiltration	Filter	RTPUFP-30-C-5S	1	\$2,179	\$13,074
Formulation and Fill	Vials	Daikyo Crystal Zenith Ready-to-Use 2mL Vials COP	250000	\$4	\$5,627,063
Formulation and Fill	Stoppers	13mm NovaPure Bromobutyl 4023/50 Lyophilization Stoppers	250000	\$1	\$1,590,797
<b>Total</b>					<b>\$7,521,837</b>

As mentioned previously, this process was found to produce 24,640 L of liquid waste and 175.6 kg of solid waste per campaign. Eldredge Inc. will be contracted for all waste disposal as this manufacturing facility will be located in West Chester, Pennsylvania. For liquid waste, Eldredge Inc. has provided a quote for the disposal at a rate of \$2.25 per gallon, so for a total of approximately 6,500 gallons this would accumulate to a cost of \$14,647 per campaign. For solid

waste, disposal will be provided at a rate of \$205 per 55 gallon drum, with a transportation fee of \$425 per load plus a 51% fuel surcharge. This service will accumulate to approximately \$1,500 per campaign, resulting in a total cost of \$96,884 per year for waste disposal.

Utilities for this process include steam, compressed air, chilled ethylene glycol, water, and power as shown in Table 5.8.7. Site utilities such as lighting and AC were not included in this analysis and were considered outside the scope of this project. Compressed air is needed to supply oxygen to the bioreactors during fermentation, and this price was estimated to be 1.8¢ per cubic meter (*How to Easily Calculate*, 2020). Steam is needed several times each campaign to sterilize buffers that are used for chromatography and the culture media used in fermentation. Cost associated with steam was estimated by calculating the energy required to heat 3000 liters of liquid water to 121 °C, a common sterilization temperature. This steam usage would happen five times a campaign. Chilled ethylene glycol is used to cool the solution before entering Protein A chromatography. Energy usage associated with cooling the ethylene glycol was found by calculating the heat removed from the heat exchanger. The price of ethylene glycol and steam, based on energy usage, were estimated using capcost spreadsheet. Water is used for media and buffer makeup and for cleaning. The cost of water in West Chester, Pennsylvania is \$30.11 for the first 2,000 gallons and \$7.99 per 1,000 gallons after that (*Borough of West Chester*, 2021). As shown in section 4.4, 24948 L or approximately 6600 gallons of water are required per campaign for this process, resulting in a total of 39600 gallons of water needed per year. Lastly, power is needed to to operate the main and ancillary equipment. Table 5.8.8 shows the power requirements for each unit with a total power consumption of 4680 kWh per campaign. The cost of power in Westchester Pennsylvania was assumed to be 8.99 ¢ per kWh (*Residential Electricity & Gas*, 2022). Therefore, the total cost of utilities per year was determined to be \$3,008.

Table 5.8.7  
Annual Use and Cost of Utilities

Utility	Units Consumed per Year	Price per Unit	Cost per Year
Steam	35.28 GJ	\$2.08 per GJ	\$73.38
Compressed Air	259.2 m <sup>3</sup>	\$0.018 per m <sup>3</sup>	\$4.58
Chilled Ethylene Glycol	108 kWh	\$0.037 per kWh	\$4
Water	39600 gallons	\$0.01 per gallon	\$401
Power	28080 kWh	\$0.0899 per kWh	\$2,525
<b>Total</b>			<b>\$3,008</b>

Table 5.8.8  
Total Manufacturing Power Consumption

Unit	Model	Quantity	System Power Requirement (kW)	Power per Campaign (kWhr)	Cost per Campaign
<b>Main Equipment</b>					
WCB Storage	VIP ECO Model MDF-DU702VH-PA Freezer	1	-	264	\$23.71
WCB Thawing	Thermo Fisher Precision GP 02 water bath	1	0.414	0.414	\$0.04
Fermentation	WAVE 25 Rocker Reactor	1	1.50	285	\$25.62
	Xcellerex XDR 50	1	0.012	0.357	\$0.03
	Xcellerex XDR 500	3	0.053	41.6	\$3.74
First UF	ÄKTA Flux 6	1	0.400	288	\$25.89
Chromatography	ÄKTA pcc	3	0.800	1728	\$155.35
DF Before Chromatography	ÄKTA Flux S tangential flow filtration system	2	0.300	432	\$38.84
VF	Planova Single-Use Virus Filtration Controller	1	0.031	22.4	\$2.01
Final UF and DF	AKTA ReadyFlux Tangential Flow Filtration System	2	1.00	33.3	\$3.00
Formulation and Fill	SA25 Aseptic Filling Workcell	1	16.1	268	\$24.09
Lyophilizer	Q144XSS from Millrock Technology	1	5.13	1231	\$110.65
<b>Ancillary Equipment</b>					
Peristaltic Pumps	Masterflex™ L/S™ Variable-Speed Console Drive with Pump Head Bundles	27	-	6.94	\$0.62
Mixers for tanks under 3000 L	1/3 HP Electric Direct Drive Economy Clamp Mount	11	0.249	27.34	\$2.46
Mixers for tanks above 3000 L	Raiden Standard 2 HP Plate Mount Top Entry Mixer	1	1.49	14.9	\$1.34
WFI System	Medica® Pro-RE	1	0.052	37.5	\$3.37
<b>Total</b>					<b>\$420.76</b>

The cost of operating labor was calculated using equation 5.8.3 (Turton et al., 2012). In this equation,  $N_{OL}$  represents the number of operators needed per shift,  $P$  represents the number of process steps involving operators handling particulate solids, and  $N_{np}$  represents the remaining process steps. For this manufacturing process, it was assumed there were 3 process steps that involve the handling of particulate solids: transferring cells between reactors during inoculation, mixing buffers, and autoclaving buffers. Based off of the remaining unit operations and ancillary equipment, we determined that there were 15 process steps that did not involve the handling of particulate matter. With these numbers, Equation 5.8.3 estimates that 17 operators are needed per shift.

$$N_{OL} = (6.29 + 31.7P^2 + 0.23N_{np})^{0.5}$$

Equation 5.8.3. Estimating Number of Operators per Shift (Turton et al., 2012)

It was assumed that the operators would work five 8-hour shifts over the course of a week. It was also assumed that each operator would get a combined three weeks of vacation and sick days. Because this plant is running 24 hours per day, 7 days per week, our plant needs roughly 4.5 times the number of operators required for each shift to keep the plant running year round (Turton et al., 2012). For our process, year round is actually only six months of production. The average pharmaceutical operator salary is \$66,300 per year, including bonuses and profit sharing (*Pharmaceutical Operator Salaries*, 2021). Because the plant is not running the full year, we chose to contract the operators for \$49725 (75% of their annual pay) for 6 months of labor. This resulted in a total of \$3.8 million in operating labor each year.

#### **5.8.4 Economic Analysis using Discounted Cash Flow**

A cash flow analysis of this project is accomplished through a comparison of the initial capital costs, operating expenses, and the estimated revenue of the mAb product. Due to the small size of the equipment and that this product is a biosimilar of an already existing drug, the

time for construction was estimated to be 12 months. Validation will start at the same time as construction, but it will last for a total of 18 months. The plant will be run during the last six months of validation to perform quality testing on the product. Once validation is complete, this plant will be in operation for 10 years before shutting it down and salvaging the equipment. This brings the total lifetime of the plant to 11.5 years

Important values for the economic analysis of this plant are detailed in Table 5.8.9. Initial capital investment for this plant, including land, construction, and equipment costs, are detailed in section 5.8.1. This capital cost was found to be \$65.5 million. To ensure the safety and efficacy of our product, the FDA must validate the process before we can sell it. The cost of validation of our plant was estimated to be \$1 million. Costs associated with the annual operation of the plant are detailed in section 5.8.3, these costs sum to \$44 million per year.

While the introduction of a generic may drastically lower the price of a standard brand-name drug, this is not necessarily the case with biologics (Becker, 2022). Therefore it is assumed that the price of Humira will remain constant at \$6240 for two 40 mg doses of Humira (*Humira prices*, 2021). In the EU, it is reasonable for biosimilars to enter the market at 30% of the price of the name brand drug (Blackstone & Fuhr, 2013). With this estimate, it is expected that our process will sell adalimumab at \$4350 for two 40 mg doses. Revenue generated from the product is estimated by multiplying the amount of product to be made in a year,  $60 \times 10^6$  mg, by the price the product will be sold for, 54.6 \$/mg. From this, annual revenue was found to be \$3.3 billion per year. Federal capital gains tax is 20%, while the commercial tax rate in Pennsylvania is slightly under 11%. All of these taken together make the annual profit to be approximately \$2.2 billion per year.

Table 5.8.9  
Important Values for Economic Overview

Capital Cost	\$64,513,152
Validation	\$1,000,000
Operation Costs	\$44,290,428
Annual Revenue	\$3,262,500,000
Tax Rate	31%
Annual Profit	\$2,220,886,425

To further examine the profitability of our process, we performed a discounted cash flow analysis. First, it was decided that the initial capital investment would be paid over the course of the first five years of plant operation and this cost of investment was treated as an expense. No revenue was generated during the 12 months of construction, nor the additional 6 months of product testing. During product testing, we assumed an operational cost of \$22 million to reflect half of the annual operating expenditures. A discount rate of 20% was applied for our analysis. This conservative discount rate was chosen to account for instability in the pharmaceutical market as well as depreciation over time. Discounted cash flow was calculated by Equation 5.8.4. In this equation,  $TCF_t$  is taxed cash flow in year  $t$ ,  $DCF_t$  is discounted cash flow in year  $t$ , and  $i$  is the discount rate, 20%. This discounted, or present value, cash flow gives a more accurate projection of the value of profit in the future to help the profitability analysis. These present values were then summed over time to give a cumulative discounted cash flow.

$$TCF_t = DCF_t(1 - i)^t$$

Equation 5.8.4. Equation for discounted cash flow in year  $t$



Table 5.8.10  
Discounted Cash Flow Analysis

Year	Net Cash Flow after-tax	PV of Cash Flow	Cumulative Discounted Cash Flow
-1.5	-\$64,513,152	-\$84,804,741	-\$84,804,741
-1	-\$23,145,214	-\$27,774,257	-\$112,578,998
0	\$2,211,844,300	\$2,211,844,300	\$2,099,265,302
1	\$2,211,844,300	\$1,843,203,583	\$3,942,468,886
2	\$2,211,844,300	\$1,536,002,986	\$5,478,471,872
3	\$2,211,844,300	\$1,280,002,489	\$6,758,474,360
4	\$2,211,844,300	\$1,066,668,740	\$7,825,143,101
5	\$2,220,886,425	\$892,524,444	\$8,717,667,545
6	\$2,220,886,425	\$743,770,370	\$9,461,437,915
7	\$2,220,886,425	\$619,808,642	\$10,081,246,557
8	\$2,220,886,425	\$516,507,202	\$10,597,753,759
9	\$2,220,886,425	\$430,422,668	\$11,028,176,427
10	\$2,220,886,425	\$358,685,557	\$11,386,861,984

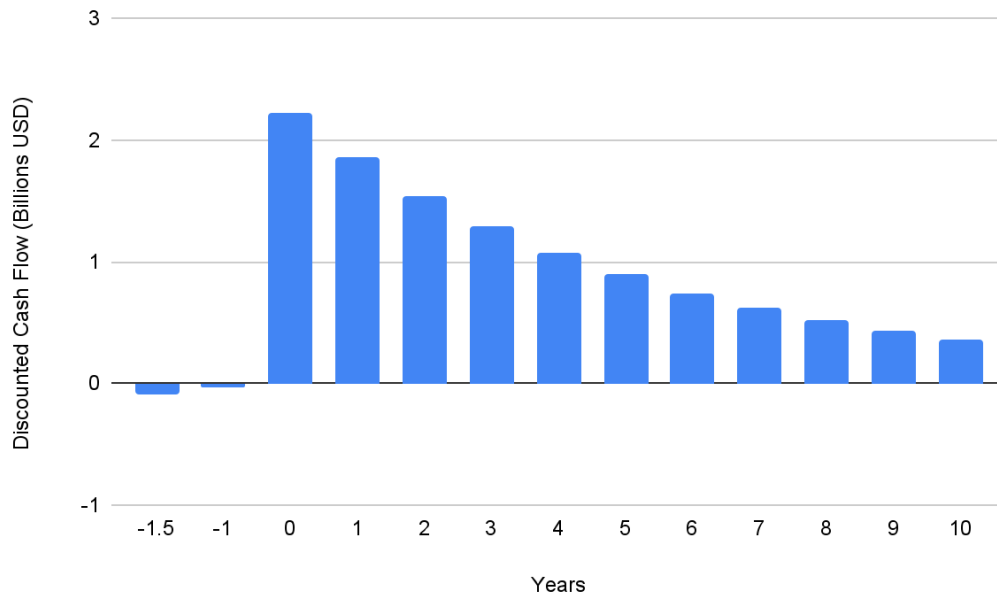

Figure 5.8.1. Discounted Cash Flow over Plant Lifetime

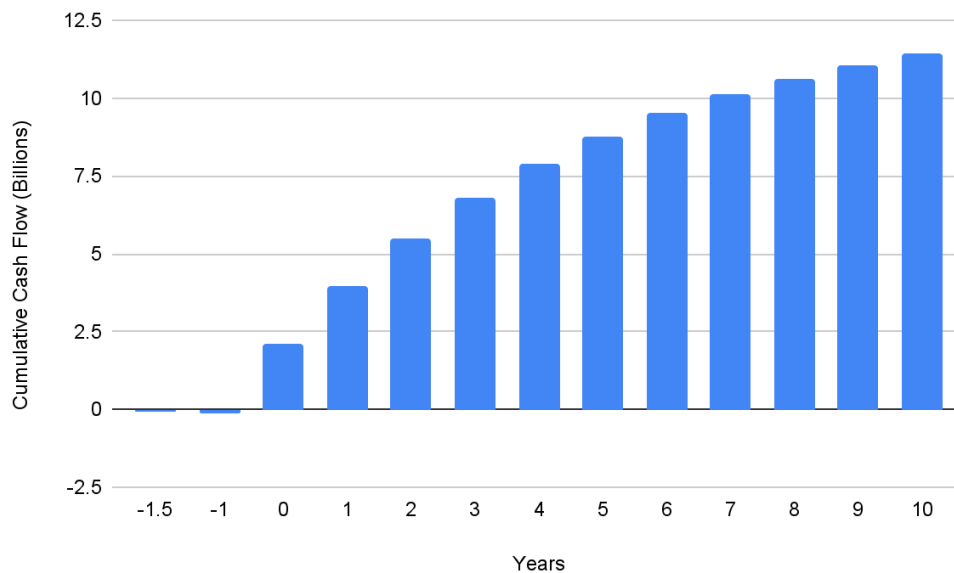

Figure 5.8.2. Cumulative Cash Flow over Plant Lifetime

After this discounted cash flow analysis, the net present value of this project was found using Equations 5.8.5 and 5.8.6. Here, NPV is net present value and CCF is cumulative cash flow.  $P$  represents the principle, or initial capital investment, and  $i$  represents the discount rate, 20%. The final variable,  $R$ , is the internal rate of return which gives information about how high the discount rate would need to be for the project to make no profit. Our internal rate of return was found to be 960%. Through the discounted cash flow analysis, the net present value and internal rate of return were found to be well within the bounds to make this project profitable.

$$NPV_{10} = CCF_{10}(1 + i)^{10}$$

Equation 5.8.5. Equation for net present value at year 10

$$P(1 + R)^{10} - P(1 + i)^{10} = NPV_{10}$$

Equation 5.8.6. Equation for internal rate of return at year 10

### 5.8.5 Risk Analysis

The predictions to arrive at this economic analysis make several assumptions. It was assumed that Abbvie would not lower the price of Humira and that a 30% reduction in price

would make the biosimilar competitive. It was assumed that demand for adalimumab would increase with the introduction of a biosimilar and that all biosimilars would absorb 40% of this market. Out of the nine biosimilars who have reached settlements with Abbvie, we predicted that four would be successful and that all four biosimilars would split the 40% market share evenly. We estimated that the discount factor would be 20% for a biosimilar of an established drug and that it would take 1.5 years of construction and validation before production could begin. All of this illustrates that many assumptions were made at the arrival of our economic analysis, and while we may have underestimated the success of our product in some areas, some of our other assumptions may not work in our favor.

In order to be thorough with our economic analysis, we examined a few scenarios where our predictions did not go according to plan in order to determine whether our process would still be profitable. The first scenario is the case where the discount factor increased to 40%, double than what we initially predicted. In this case, while Figure 5.8.3 shows there is a significant loss of profits after ten years, the cumulative cash flow is still highly profitable at a little less than \$7.5 billion dollars and the same internal rate of return of 960%.

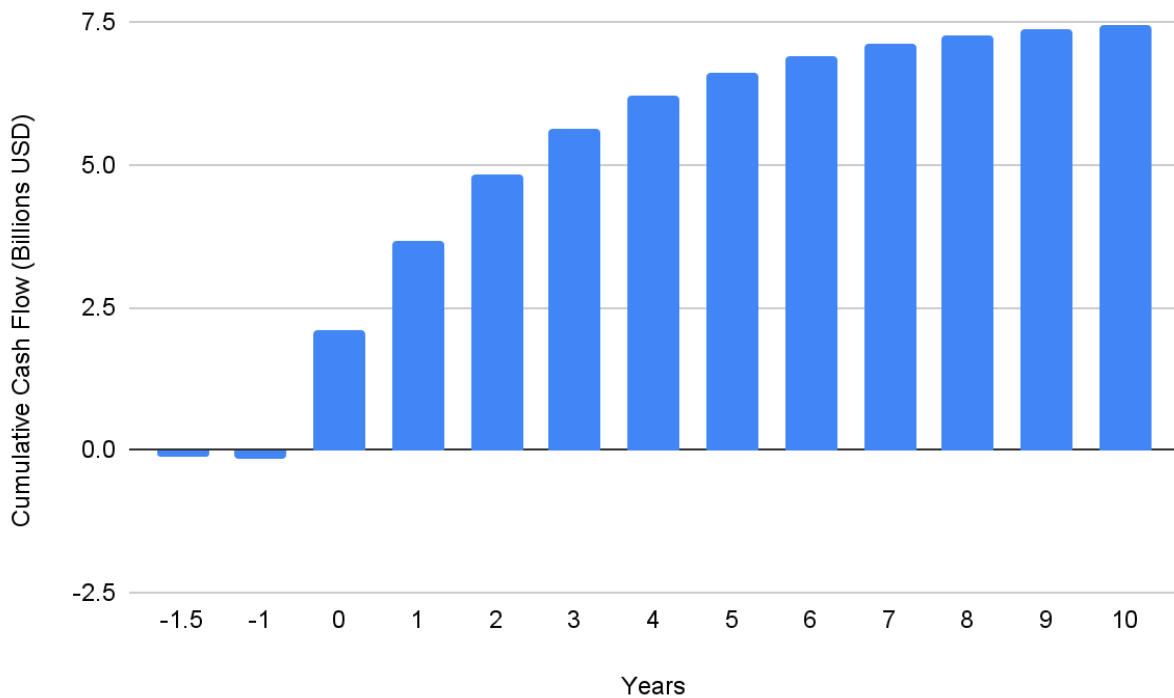

Figure 5.8.3. Cumulative Cash Flow with 40% Discount Rate

In the other scenario, the effect on profitability from delaying production by a year was examined. This delayed start up may have been caused by a longer construction period, unanticipated problems with validation, or any other concerns that would prevent the sale of adalimumab. Figure 5.8.4 shows there was still a significant hit to revenue in this scenario, but it had a net present value greater than \$7.5 billion and an internal rate of return of 330%.

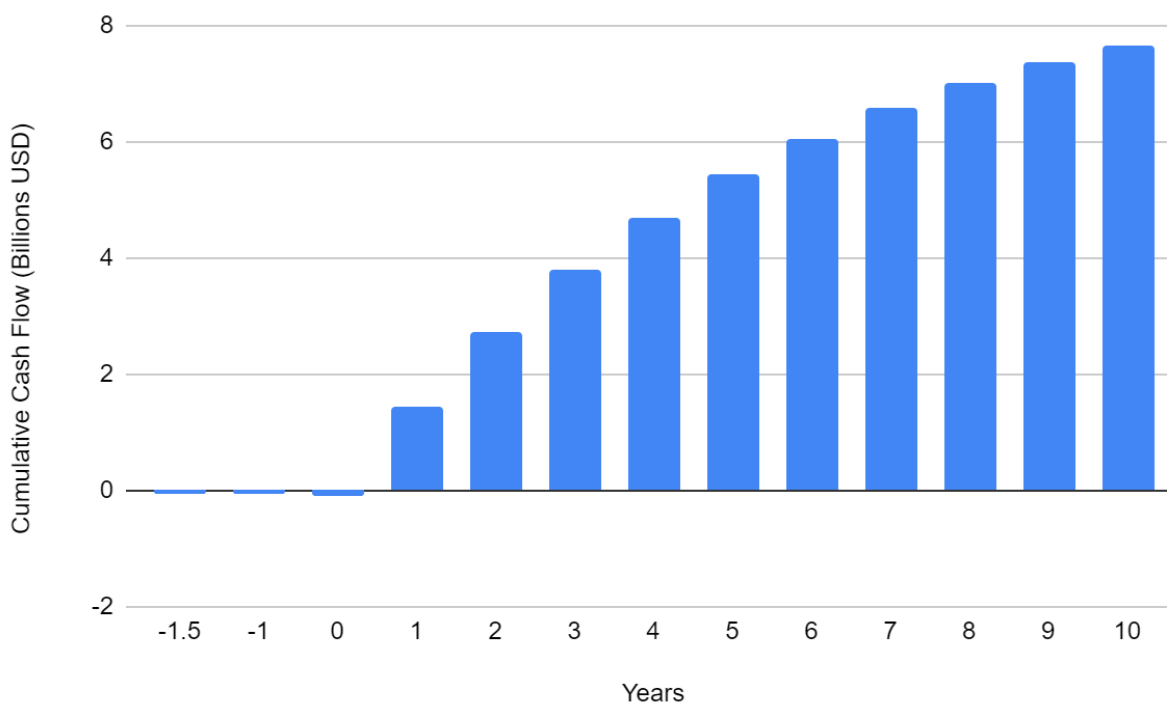

Figure 5.8.4. Cumulative Cash Flow with Delayed Start Up

## 5.9 Quality Control

Our plant will be equipped with the necessary equipment and facilities in order to conduct testing on our product to ensure it complies with FDA standards and regulations for current Good Manufacturing Practice (cGMP). First and foremost, the manufacturing facility and its employees will have developed a standard operating procedure, which will include in-depth details on the actions performed and methods used by various engineers and operators to ensure the delivery of a safe, pure, and potent product (U.S. Food and Drug Administration, 2020). In order to ensure that operations of the facility are in accordance with the standard operating procedure, a variety of testing for certain critical quality attributes (CQAs) will be implemented at each step of the manufacturing process.

The CQAs identified in our process can be categorized into three main groups: physical and chemical properties, potency, and product/process related impurities. Physical and chemical

properties of significance are the purity and identity of the product. Our facility will employ SDS-polyacrylamide gel electrophoresis, size-exclusion high performance liquid chromatography, mass spectrometry, isoelectric focusing, and peptide mapping as a means of assessing these properties (Flatman et al., 2007). Results will be compared to a parent-lot of product that has undergone testing for all requirements and is able to be released according to FDA regulations. To assess the potency and activity of our product, our facility will employ immunoassays and cellular assays. The immunoassays measure the specific binding to an antigen as well as the binding rate, and are highly effective tools. Cellular assays will also be used to measure potency and activity, and although they are generally less accurate than binding assays, combining them with binding assays is an adequate method of assuring capability of lot release (Flatman et al., 2007). Lastly, product/process related impurities will be assessed through the methods mentioned above as well as PCR testing for host-cell DNA impurities. Each of the analytical methods described will be used at varying points of the process in accordance to their function.

To ensure that the integrity of the product is maintained at all points in the process, quality control testing will occur before and after each unit operation, once per hour. This rigorous testing is absolutely essential for safe lot release. All data collected from testing will be compiled for reporting purposes to the FDA when required for continuous validation purposes. In addition to monitoring specific product-related qualities of our facility, analytical monitoring will be employed for other aspects of the process, including but not limited to flow rates, temperatures, and pressures. All of our unit operation systems have the capability to measure these parameters.

In the event that disturbances in the process occur and have the possibility of creating nonconforming materials, our system will be equipped with capabilities to selectively divert and analyze material. If this material is deemed nonconforming, our material traceability, process monitoring, material removal methods will allow the nonconforming material to be separated and disposed of without disrupting the remainder of the product stream. Everything produced after the last conforming test will also be directed to waste. However, in order to minimize potential disruptions in manufacturing, our facility and its engineers and operators will conduct rigorous training so that all staff possess the necessary knowledge and skills to operate a cGMP facility.

## **6. Regulatory, Safety, Health, and Environmental Considerations**

This manufacturing facility is required to maintain compliance with a wide variety of FDA regulations. The FDA has published a series of guidelines for industrial practice that outline the necessary steps for manufacturers to take in order to comply with said regulations. These include but are not limited to *Q8(R2) Pharmaceutical Development* (U.S. Food and Drug Administration, 2009a), *Q9 Quality Risk Management* (U.S. Food and Drug Administration, 2006), *Q10 Pharmaceutical Quality System* (U.S. Food and Drug Administration, 2009b), and *Q11 Development and Manufacture of Drug Substances--Questions and Answers (Chemical Entities and Biotechnological/Biological Entities)* (U.S. Food and Drug Administration, 2018). These guidance documents provide manufacturers a how-to list for compliance with cGMP and quality by design. So, our facility will reference these guides to determine sufficient operating procedures, facility protocols, quality testing, and process validation practices to achieve approval for lot release for every campaign. Following these guidelines will ensure safety, purity, efficacy, stability, and consistency of the product.

With all pharmaceutical products, there is a safety risk to patients. Therefore to ensure that this product is safe for consumption, the facility will undergo validation before beginning manufacturing. Additionally, rigorous quality testing will be conducted as explained in section 5.9 to monitor product safety, purity, and potency throughout manufacturing. In addition to patient safety, employees will be working around hazardous materials and equipment. The major material hazards in this process are from corrosive chemicals used for buffers and cleaning and from biological hazards. These chemicals include sodium hydroxide, phosphoric acid, and sodium phosphate and can cause severe burns or eye damage. As such, all operators will be required to wear proper PPE as designated by OSHA and must undergo proper training to handle



such chemicals and to operate process equipment. This will ensure that exposure to such materials by physical contact, inhalation, and ingestion is minimized. Additionally, floor drains, eyewash stations, and chemical showers will be placed throughout the manufacturing floor and non-slip flooring will be implemented.

Environmental considerations for the overall design of this manufacturing facility fall under the scope of facility siting and waste disposal. Our facility will be located in West Chester, PA, in the suburban Philadelphia area, where many pharmaceutical companies already operate. The area is also well-developed, so it is unlikely that the facility would need to be built in an area that would drastically influence the local environment. Some important features of the local environment in the surrounding area are the Brandywine River, Stroud Preserve, and Marsh Creek State Park. To ensure that these areas are unaffected by our facility, the necessary steps will be taken to ensure construction can be done as far from these locations as possible. In terms of waste disposal, our facility has contracted Eldredge Inc. to dispose of all liquid and solid waste in accordance with local, state, and federal laws and regulations, and to dispose of the solid waste via incineration to minimize environmental impact.

## **7. Social and Ethical Considerations**

In any manufacturing process, it is important to consider the social and ethical aspects of the product that is being created. This is especially important in the pharmaceutical industry because of the importance that the product has in the lives of consumers. Therefore, our design goal has been to maximize the benefits that our product will give to consumers and reduce the costs patients have to pay to receive adalimumab. In addition, we also intend to consider the impacts that the manufacturing process will have on residents near the plant, employees, and the company as a whole.

Designing our plant in a way that utilizes continuous processing aids us in saving time and reducing manufacturing cost. Historically, pharmaceutical processes are performed in batches, whereby specific quantities of product are created at once before the entire process is repeated again. This manufacturing method results in long waits between batches, potential issues with an entire batch, and less product due to the periods where nothing is produced. However, in a continuous process such as the one described in this paper, our product is continuously being produced. In addition, the continuous perfusion reactor produces more product thanks to the ability for the reactor to be held at optimal productivity conditions. Another benefit to continuous manufacturing is the reduction in potential human error, as the process runs with less human operations. Overall, the continuous production for adalimumab results in a more efficient process, reducing time and energy in the production. This translates to real cost savings for patients, making adalimumab more accessible.

Another beneficial aspect of this process design is the integration of single-use materials wherever possible. Although some operations in our process cannot be entirely single use, our process was designed to maximize the processes compatible with single-use equipment. This can

be seen especially with the decision to collect and run our product through the final stages so that single-use materials could be used. Processes without single-use equipment must be frequently cleaned, which takes up time, labor, and money. On the other hand, single-use materials are easy to replace and require less training, cleaning materials, and time. Again, these impacts translate into reduced costs for the final product. Also, it is important to mention that the use of single-use materials is not necessarily worse for the environment, as the single-use plastic used in the biotechnology industry is strictly regulated and must be properly disposed of in a way that minimizes environmental impact.

In considering the impacts of our manufacturing process, we must consider how the plant will affect those who live nearby. As with any other manufacturing plant, we will likely contribute to noise levels in the surrounding community. However, as West Chester, Pennsylvania is a relatively popular location for other biotechnology companies, the noise levels will likely not be much in addition to the already existing noise. In addition, the waste that we will produce is largely in solid and liquid form, and will be dealt with according to strict FDA regulations, and will not affect the local communities or environment.

Finally, the last group that we must consider our impacts on are the employees of our production facility. When employees are hired, they will undergo strict safety and ethical training programs to ensure that they are not harmed in the production facility and know how to prevent contamination of the product. In addition, employees will be provided with a competitive salary and comprehensive benefits.

## **8. Conclusion and Recommendations**

This report demonstrates the viability of producing a Humira biosimilar using a continuous and single-use process design. Operating continuously will increase plant capacity while decreasing labor requirements and operating costs. Additionally, implementing single-use equipment will reduce the need for traditional cleaning and sterilization techniques and lower the risk of product contamination. The proposed process will be able to manufacture 60 kg of adalimumab in 7 months across six campaigns. This is enough product to take over 10% of the current market for adalimumab, allowing patients to receive needed medicine at a lower cost. By only designing for 7 months of operation, this facility has the potential to increase its production capacity if product demand grows overtime. With selling our product for 30% less than Abbvie's Humira, the net present value of this designed facility will be \$11.4 billion with an internal rate of return of 960% after 10 years of operation, showing that this process is highly profitable.

With any pharmaceutical product, there are concerns with product safety and quality. However, the proposed design follows cGMP guidelines and implements rigorous quality controls, and therefore adds no extra risks to patients and employees than current manufacturing facilities. To reduce the uncertainty of our assumptions, we recommend performing additional testing on the isoelectric point of adalimumab, the sensitivity of the dilution rate in the bioreactor, the dynamic binding capacity of resins purchased for chromatography, and other parameters that may affect the upstream titer. Due to the added patient benefits, profitability, and safety of this design, our team recommends the implementation of this process by one of the companies recently approved to produce an adalimumab biosimilar. Our analysis indicates that this project is ready for validation and construction.

## **9. Acknowledgement**

Throughout the duration of our project, there have been many individuals who have contributed their time and expertise to aid us in this design. We would like to sincerely thank Professor Eric Anderson, Professor George Prpich, Professor Giorgio Carta, and Professor Micheal King for their help. Professor Anderson was significant in ensuring that our project stayed on track and quickly providing suggestions for solving any issues that came up along the way. Professors Prpich, Carta, and King provided invaluable insight into the pharmaceutical industry, each in the area of their expertise, allowing us to ensure our process was designed in a manner consistent with existing pharmaceutical standards. Lastly, our team would like to thank the University of Virginia community, our family, and our friends for keeping us sane through the years in our efforts to get our chemical engineering degrees.

## 10. Table of Nomenclature

Equation No. (First Appearance)	Symbol	Definition	Unit
4.1.1	$\mu$	Specific Growth Rate	$\text{h}^{-1}$
	$K_s$	Monod saturation constant	g/L
	S	Concentration of substrate*	g/L
4.1.2	V	Volume	L
	F	Flow rate of cell media into reactor*	mL/h
4.1.3	X	Concentration of CHO cells*	g/L
4.1.4	$Y_{X/S}$	Amount of cells produced versus substrate consumed	g cell / g substrate
4.1.5	P	Concentration of product*	g/L
	$Y_{X/P}$	Yield of cells produced versus product produced	g cell / g product
4.1.9	$C_{O_2}$	Concentration of oxygen	g/L
	$C^*_{O_2}$	Solubility of oxygen	g/L
	$k_L a$	Mass transfer coefficient	$\text{h}^{-1}$
	$Y_{X/O_2}$	Amount of cells produced versus oxygen consumed	g cell / g oxygen
4.1.10	$Q_{O_2}$	Specific oxygen demand	mmol $O_2$ / gh
4.1.11	$D_t$	Tank diameter	m
	$H_L$	Liquid height in tank	m
	$Q_g$	Aeration rate	vvm
	$v_s$	Superficial velocity	m/s
4.1.12	$D_i$	Impeller diameter	m
	N	Impeller speed	RPM

	$P_g$	Total power input required for the system	W
	$N_p$	Power number	dimensionless
	$N_a$	Aeration number	dimensionless
4.1.13	D	Dilution rate	$h^{-1}$
4.1.14	a	Recycle ratio	dimensionless
	b	Concentration factor	dimensionless
4.1.17	$D_{washout}$	Washout dilution rate	$h^{-1}$
	$D_{opt}$	Optimal dilution rate	$h^{-1}$
4.1.21	$\bar{v}$	Flow velocity	m/s
	$\Delta P$	Pressure change	bar
4.2.1	Re	Reynold's number	dimensionless
	$Q_t$	Flow rate per tube	mL/h
	$d_t$	Tube diameter	m
	$\nu$	Kinematic viscosity	$m^2/s$
4.2.2	$f$	Friction factor	dimensionless
4.2.3	L	Tube length	m
	$\rho$	Density	$kg/m^3$
4.2.4	$DBC_{10\%}$	Dynamic binding capacity at 10% breakthrough	mg/mL
	$V_{load}$	Load volume	mL
	$V_{column}$	Column volume	mL
	$C_F$	Feed concentration	mg/mL
4.2.5	$\varepsilon$	Extraparticle porosity	dimensionless
	$d_p$	Average particle diameter	$\mu m$
	L	Column length	cm

	$u$	Superficial velocity	m/s
	$\eta$	Viscosity	Pa s
4.2.6	$t$	Time in reactor	s
	$\tau$	Residence time	s
4.2.7	$t$	Minimum time in reactor	s
	$L$	Tube length	m
	$U_{\max}$	Maximum velocity	m/s
	$U_{\text{avg}}$	Average velocity	m/s
	$R$	Radius	M
	$V$	Volume of tube	L
	$v_0$	Volumetric flow rate	L/s
	$\tau$	Residence time	s
4.2.9	$V^{\circ}$	Volumetric flow	L/s
	$A$	Area	cm <sup>2</sup>
4.3.1	$P$	Power requirement	W
	$\eta$	Pump efficiency	dimensionless
4.3.2	$\Delta T_{\text{lm}}$	Logarithmic mean temperature difference	°C
4.3.3	$Q$	Heat transfer requirement	W
	$C_p$	Heat capacity	J/kgK
	$m$	Mass flow rate	kg/s
4.3.4	$A$	Heat transfer area	m <sup>2</sup>
	$U_0$	Overall heat transfer resistance	W/m <sup>2</sup> K
5.8.2	COM	Cost of manufacturing	\$
	FCI	Fixed capital Investment	\$



	$C_{RM}$	Cost of raw materials	\$
	$C_{WT}$	Cost of waste treatment	\$
	$C_{UT}$	Cost of utilities	\$
	$C_{OL}$	Cost of operating labor	\$
5.8.3	$N_{OL}$	Number of operators	dimensionless
	P	Number of process steps involving particulate solids	dimensionless
	$N_{np}$	Number of process steps not involving particulate solids	dimensionless
5.8.4	$TCF_t$	Taxed cash flow at year t	\$
	$DCF_t$	Discounted cash flow at year t	\$
	t	Time	year
	i	Discount rate	dimensionless
5.8.5	$NPV_t$	Net present value at year t	\$
	$CCF_t$	Cumulative cash flow at year t	\$
5.8.6	P	Principle capital investment	\$
	R	Internal rate of return	%

\*Subscripts to these variables denote the specific streams being described

## **11. References**

*1/3 HP electric direct drive economy clamp mount.* (2022). Mixer Direct.

<https://www.mixerdirect.com/products/1-3-hp-electric-direct-drive-economy-clamp-mount>

*13mm NovaPure® bromobutyl lyophilization stoppers 4023/50.* (2022). West Pharmaceutical Services.

[https://www.westpharma.com/shop/lyoordrypowder%3dwesteshop\\_master%20lyo%20or%20dry%20powder/13mmNovaPureBromobutyl4023%5B%5BSS%5D%5D50LyophilizationStoppers%3d19700364?itemId=f7ef07f34cf575df5d33e3433fb4d3c9](https://www.westpharma.com/shop/lyoordrypowder%3dwesteshop_master%20lyo%20or%20dry%20powder/13mmNovaPureBromobutyl4023%5B%5BSS%5D%5D50LyophilizationStoppers%3d19700364?itemId=f7ef07f34cf575df5d33e3433fb4d3c9)

*60 Gal, 304SS, cone bottom tank, #2B finish.* (2022). Mixer Direct.

<https://www.mixerdirect.com/products/60-gal-304ss-cone-bottom-tank-2b-finish>

Abt, B., Burruss, C., Mohan, R., Rushin, N., Xu, S., & Anderson, Eric (advisor) (2020). *Design of a pembrolizumab manufacturing plant using continuous bioprocess technology and single-use bioreactors*. Charlottesville, VA: University of Virginia, School of Engineering and Applied Science, BS (Bachelor of Science), 2020. Retrieved from

<https://doi.org/10.18130/v3-1nyq-1531>

*Adalimumab.* (2021). ClinCalc. Retrieved November 19, 2021, from

<https://clincalc.com/DrugStats/Drugs/Adalimumab>

*Adalimumab biosimilars in Europe: A review.* (2020, January 31). GaBi.

<https://gabionline.net/biosimilars/general/Adalimumab-biosimilars-in-Europe-a-review>

*Adalimumab overview.* (2022). Creative Biolabs. Retrieved March 26, 2022, from

<https://www.creativebiolabs.net/adalimumab-overview.htm>

- AIChE. (2019, September 29). *Single use (SU) technologies in biomanufacturing*. AIChE. Retrieved February 18, 2022, from <https://www.aiche.org/sites/default/files/community/206296/aiche-community-site-files/51451/singleusetechologies.pdf>
- Becker, C. (2022, January). *Decreasing drug costs through generics and biosimilars*. National Conference of State Legislatures. <https://www.ncsl.org/research/health/decreasing-drug-costs-through-biosimilars.aspx>
- Bhambhani, A., Blue, J., & 2010. (2010, January 1). *Lyophilization strategies for development of a high-concentration monoclonal antibody formulation: Benefits and pitfalls*. <http://www.americanpharmaceuticalreview.com/Featured-Articles/117600-Lyophilization-Strategies-for-Development-of-a-High-Concentration-Monoclonal-Antibody-Formulation-Benefits-and-Pitfalls/>
- Billups, M., Minervini, M., Holstein, M., Feroz, H., Ranjan, S., Hung, J., Bao, H., Ghose, S., Li, Z. J., & Zydney, A. L. (2021). *Antibody retention by virus filtration membranes: Polarization and sieving effects*. *Journal of Membrane Science*, 620(118884). <https://doi.org/10.1016/j.memsci.2020.118884>
- Biosimilar product information*. (2021, September 20). FDA. Retrieved November 25, 2021, from <https://www.fda.gov/drugs/biosimilars/biosimilar-product-information>.
- Blackstone, E. A., & Fuhr, J. P. (2013). The Economics of Biosimilars. *American Health & Drug Benefits*, 6(8), 469–478.
- Borough of West Chester. (2021, February 1). *Water & sewer bill*. Retrieved April 7, 2022, from <https://www.west-chester.com/171/Water-Sewer-Bill>

- Burns, G., Caveney, M., Lee, D., Letteri, J., Pellegrin, M., & Anderson, Eric (advisor) (2021). *Design of an Amgen Trastuzumab manufacturing facility to continuously produce Kanjinti, a HER2+ breast cancer treatment biosimilar*. Charlottesville, VA: University of Virginia, School of Engineering and Applied Science, BS (Bachelor of Science), 2021. Retrieved from <https://doi.org/10.18130/jvzb-ks41>
- Carta, G. (Presenter). (2021). *Membrane based separations*. Lecture presented at University of Virginia, Charlottesville.
- Citric acid monohydrate*. (2022). Millipore Sigma. <http://www.sigmaaldrich.com/>
- Chen, Y., Monnard, A., & Santos da Silva, J. (2021, June 7). *An inflection point for biosimilars*. McKinsey & Company. Retrieved November 19, 2021, from <https://www.mckinsey.com/industries/life-sciences/our-insights/an-inflection-point-for-biosimilars>
- Coghlan, J., He, H., & Schwendeman, A. S. (2021). *Overview of Humira® biosimilars: Current European landscape and future implications*. *Journal of Pharmaceutical Sciences*, 110(4), 1572–1582. <https://doi.org/10.1016/j.xphs.2021.02.003>
- Cunningham, M., Mahadevan, J., & Bausch, M. (2021). *Preparing CHO cells for higher productivity by optimizing a perfused seed train*. Millipore Sigma. Retrieved November 25, 2021, from <https://www.sigmaaldrich.com/US/en/technical-documents/technical-article/pharmaceutical-and-biopharmaceutical-manufacturing/monoclonal-antibody-manufacturing/higher-productivity-cho-cell>.
- Curtis, M. (2018). *Protein A chromatography in monoclonal antibody purification*. Kansas State University.

<https://krex.k-state.edu/dspace/bitstream/handle/2097/39284/MichaelCurtis2018.pdf?sequence=3>

Cytiva. (2020a). *Capto S ImpAct*. Cytiva.

<https://cdn.cytivalifesciences.com/dmm3bwsv3/AssetStream.aspx?mediaformatid=10061&destinationid=10016&assetid=17317>

Cytiva. (2020b). *Capto S, Capto Q, and Capto DEAE*. Cytiva.

<https://cdn.cytivalifesciences.com/dmm3bwsv3/AssetStream.aspx?mediaformatid=10061&destinationid=10016&assetid=11114>

Cytiva. (2020c). *Dynamic binding capacity study on MabSelect SuRe LX for capturing high-titer monoclonal antibodies*. Cytiva.

<https://cdn.cytivalifesciences.com/api/public/content/digi-15746-pdf>

Cytiva. (2020d). *MabSelect SuRe LX: Affinity chromatography*. Cytiva. Retrieved February 18, 2022, from

<https://cdn.cytivalifesciences.com/dmm3bwsv3/AssetStream.aspx?mediaformatid=10061&destinationid=10016&assetid=15749>

Cytiva. (2020e). *MabSelect SuRe LX*. Cytiva.

<https://cdn.cytivalifesciences.com/dmm3bwsv3/AssetStream.aspx?mediaformatid=10061&destinationid=10016&assetid=15712>

Cytiva. (2020f). *One-step seed culture expansion from one vial of high-density cell bank to 2000 L production bioreactor*. Cytiva. Retrieved March 14, 2022, from

<https://cdn.cytivalifesciences.com/dmm3bwsv3/AssetStream.aspx?mediaformatid=10061&destinationid=10016&assetid=17729>

Cytiva. (2020g). *Process-scale purification of monoclonal antibodies – polishing using Capto Q*.

Cytiva. Retrieved February 18, 2022, from

<https://cdn.cytivalifesciences.com/dmm3bwsv3/AssetStream.aspx?mediaformatid=10061&destinationid=10016&assetid=14894>

Cytiva. (2020h). *Xcellerex XDR cell culture bioreactor systems*. Cytiva. Retrieved November 25, 2021, from

<https://cdn.cytivalifesciences.com/dmm3bwsv3/AssetStream.aspx?mediaformatid=1006&destinationid=10016&assetid=23694>

Cytiva. (2021). *Cross flow filtration method*. Cytiva.

<https://cdn.cytivalifesciences.com/dmm3bwsv3/AssetStream.aspx?mediaformatid=10061&destinationid=10016&assetid=17054>

Cytiva. (2022a). *ÄKTA flux tangential flow filtration system*. Cytiva.

<https://www.cytivalifesciences.com/en/us/shop/bioprocessing-filtration/tangential-flow-filtration/filtration-systems/akta-flux-tangential-flow-filtration-system-p-05755>

Cytiva. (2022b). *ÄKTA readyflux tangential flow filtration system*. Cytiva.

<https://www.cytivalifesciences.com/en/us/shop/bioprocessing-filtration/tangential-flow-filtration/filtration-systems/akta-readyflux-p-07377>

Cytiva. (2022c). *Capto Q ion exchange chromatography resin*. Cytiva. Retrieved February 18, 2022, from

<https://www.cytivalifesciences.com/en/us/shop/chromatography/resins/ion-exchange/capto-q-ion-exchange-chromatography-resin-p-00599>

Cytiva. (2022d). *HiScale™ chromatography columns*. Cytiva. Retrieved February 18, 2022, from

<https://www.cytivalifesciences.com/en/us/shop/chromatography/columns/empty-columns-for-lab-scale/hiscale-empty-chromatography-columns-p-05574#tech-spec-table>

Cytiva. (2022e). *ReadyToProcess single-use hollow fiber cartridges*. Cytiva.

<https://www.cytivalifesciences.com/en/us/shop/bioprocessing-filtration/tangential-flow-filtration/single-use-hollow-fiber-cartridges/readytoprocess-single-use-hollow-fiber-cartridges-for-ultrafiltration-p-00069#related-documents>

Cytiva. (2022f). *SA25 Aseptic filling workcell*. Vanrx. Retrieved February 1, 2022, from

<https://vanrx.com/products/sa25-aseptic-filling-workcell/>

Cytiva. (2022g). *Single-use ReadyToProcess WAVE Cellbag bioreactor*. Cytiva.

<https://www.cytivalifesciences.com/en/us/shop/cell-culture-and-fermentation/rocking-bioreactors/consumables-and-accessories/single-use-readytoprocess-wave-cellbag-bioreactors-p-00346#tech-spec-table>

Cytiva. (2022h). *Start AXH and AXM ultrafiltration hollow fiber tangential flow cartridges*.

Cytiva.

<https://www.cytivalifesciences.com/en/us/shop/bioprocessing-filtration/tangential-flow-filtration/hollow-fiber-cartridges/start-axh-and-axm-ultrafiltration-hollow-fiber-tangential-flow-cartridges-p-00507>

Cytiva. (2022i). *Xcellerex automated perfusion system*. Cytiva. Retrieved March 14, 2022, from

<https://www.cytivalifesciences.com/en/us/shop/cell-culture-and-fermentation/perfusion-systems/xcellerex-automated-perfusion-system-p-24623>

Cytiva. (2022j). *Xcellerex XDR 50 to 2000 single-use stirred-tank bioreactors*. Cytiva. Retrieved

March 14, 2022, from

<https://www.cytivalifesciences.com/en/us/shop/cell-culture-and-fermentation/single-use-bioreactor-systems/xcellerex-xdr-50-to-2000-single-use-stirred-tank-bioreactors-p-06177>

*D -Mannitol*. (2022). Millipore Sigma. <http://www.sigmaaldrich.com/>

Dale, P. (2013). *Peristaltic benefits for technical edge*. *World Pumps*, 2013(3), 32–34.  
[https://doi.org/10.1016/S0262-1762\(13\)70094-4](https://doi.org/10.1016/S0262-1762(13)70094-4)

*Daikyo crystal Zenith® 2ml sterile vials* (2022). West Pharmaceutical Services.  
[https://www.westpharma.com/shop/vials%3dwesteshop\\_master%20vials/DaikyoCrystalZenithReady-to-Use2mLVialsCOP%3d19550210?itemId=0e1ef010aff8c7e4adeb26ef04d8cda7](https://www.westpharma.com/shop/vials%3dwesteshop_master%20vials/DaikyoCrystalZenithReady-to-Use2mLVialsCOP%3d19550210?itemId=0e1ef010aff8c7e4adeb26ef04d8cda7)

de la Torre, B.G. & Albericio, F. (2021). *The pharmaceutical industry in 2020. An analysis of FDA drug approvals from the perspective of molecules*. *Molecule*, 26(627), 1-14.  
<https://doi.org/10.3390/molecules26030627>

*Diafiltration*. (2020). Pall Laboratories. Retrieved November 22, 2021, from  
<https://www.pall.com/content/dam/pall/laboratory/literature-library/non-gated/Diafiltration-%20A%20Fast,%20Efficient%20Method%20for%20Desalting,%20or%20Buffer%20Exchange%20of%20Biological%20Samples.pdf>

Fisher Scientific. (2022a) *Fisher science education sodium chloride, lab grade*.  
<https://www.fishersci.com/shop/products/sodium-chloride-lab-grade/S25541B>

Fisher Scientific. (2022b). *Masterflex™ L/S™ variable-speed console drive with pump head bundles*.  
<https://www.fishersci.com/shop/products/masterflex-l-s-variable-speed-console-drive-pump-head-bundles-2/p-7182123#?keyword=>



- Flanagan, W., Brown, A., Pietrzykowski, M., Pizzi, V., Monge, M., & Sinclair, A. (2011). *An environmental life cycle assessment comparing single-use and conventional process technology*. Biopharm International.  
<https://www.biopharminternational.com/view/environmental-life-cycle-assessment-comparing-single-use-and-conventional-process-technology>
- Flatman, S., Alam, I., Gerard, J., & Mussa, N. (2007). Process analytics for purification of monoclonal antibodies. *Journal of Chromatography. B, Analytical Technologies in the Biomedical and Life Sciences*, 848(1), 79–87.  
<https://doi.org/10.1016/j.jchromb.2006.11.018>
- Fogler, S. (2006). *Distributions of Residence Times for Chemical Reactors*. In Elements of Chemical Reaction Engineering (4th edition). Prentice Hall.  
<http://websites.umich.edu/~essen/html/byconcept/chapter13.pdf>
- GE Healthcare. (2011). *Lifetime performance study of MabSelect SuRe™ LX during repeated cleaning-in-place*. General Electric Company.  
<https://cdn.cytivalifesciences.com/dmm3bwsv3/AssetStream.aspx?mediaformatid=10061&destinationid=10016&assetid=15713>
- GE Healthcare. (2015). *Continuous chromatography in downstream processing of a monoclonal antibody*. General Electric Company.  
<https://cdn.cytivalifesciences.com/dmm3bwsv3/AssetStream.aspx?mediaformatid=10061&destinationid=10016&assetid=17822>
- GE Healthcare. (2016). *Ion Exchange Chromatography Handbook*. General Electric Company.  
[https://research.fredhutch.org/content/dam/stripe/hahn/methods/biochem/Ion\\_Exchange\\_Chromatography\\_Handbook.pdf](https://research.fredhutch.org/content/dam/stripe/hahn/methods/biochem/Ion_Exchange_Chromatography_Handbook.pdf)

- GE Healthcare. (2020a). *Purification of monoclonal antibodies using modern chromatography media and membranes*. Cytiva.com. Retrieved February 18, 2022, from <https://cdn.cytivalifesciences.com/dmm3bwsv3/AssetStream.aspx?mediaformatid=10061&destinationid=10016&assetid=17015>
- GE Healthcare. (2020b). *Three-step monoclonal antibody purification processes using modern chromatography media*. General Electric Company. <https://cdn.cytivalifesciences.com/dmm3bwsv3/AssetStream.aspx?mediaformatid=10061&destinationid=10016&assetid=17638>
- Ghose, S., Hubbard, B., & Cramer, S. M. (2007). *Binding capacity differences for antibodies and Fc-fusion proteins on protein A chromatographic materials*. *Biotechnology and Bioengineering*, 96(4), 768–779. <https://doi.org/10.1002/bit.21044>
- Goudar, C. T., Piret, J. M., & Konstantinov, K. B. (2011). Estimating cell specific oxygen uptake and carbon dioxide production rates for mammalian cells in perfusion culture. *Biotechnology progress*, 27(5), 1347-1357.
- Heidemann, R., Mered, M., Wang, D. Q., Gardner, B., Zhang, C., Michaels, J., Henzler, H.-J., Abbas, N., & Konstantinov, K. (2002). *A new seed-train expansion method for recombinant mammalian cell lines*. *Cytotechnology*, 38, 99-108. <https://doi.org/10.1023/A:1021114300958>
- Herold, N. (2021, January 25). *Cost review of water for injection (WFI)*. MECO. <https://www.meco.com/cost-review-of-wfi-systems/>
- How to easily calculate the cost of your compressed air*. (2020, January 17). Nex flow air products corp. <https://www.nexflow.com/blog/easily-calculate-cost-compressed-air/>

*HUMIRA (adalimumab)*, Abbott Laboratories—Package Insert. (2002). FDA.

[https://www.accessdata.fda.gov/drugsatfda\\_docs/label/2002/adalabb1231021b.htm](https://www.accessdata.fda.gov/drugsatfda_docs/label/2002/adalabb1231021b.htm)

*Humira prices, coupons & patient assistance programs*. (2021, October 11). Drugs.Com.

<https://www.drugs.com/price-guide/humira>

*Humira*. (2002). FDA.

[https://www.accessdata.fda.gov/drugsatfda\\_docs/label/2021/125057s4171bl.pdf#page=60](https://www.accessdata.fda.gov/drugsatfda_docs/label/2021/125057s4171bl.pdf#page=60)

Hyland, E., Mant, T., Vlachos, P., Atkins, N., Ullmann, M., Roy, S., & Wagner, V. (2016).

*Comparison of the pharmacokinetics, safety, and immunogenicity of MSB11022, a biosimilar of adalimumab, with Humira® in healthy subjects*. *British Journal of Clinical Pharmacology*, 82(4), 983–993. <https://doi.org/10.1111/bcp.13039>

IQVIA Institute. (2020, October). *Biosimilars in the United States 2020–2024*. IQVIA Institute for Human Data Science.

<https://www.bigmoleculewatch.com/wp-content/uploads/sites/2/2020/10/iqvia-institute-biosimilars-in-the-united-states.pdf>

Jacobs, I., Singh, E., Sewell, L., Al-Sabbagh, A., & Shane, L. G. (2016). *Patient attitudes and understanding about biosimilars: An international cross-sectional survey*. *Patient Preference and Adherence*, 937. <https://doi.org/10.2147/PPA.S104891>

James, B. (2015, March 10). *Mixing 101: Optimal tank design*. Dynamix Agitators Inc.

<https://dynamixinc.com/optimal-tank-design/>

Jin, W., Xing, Z., Song, Y., Huang, C., Xu, X., Ghose, S., & Li, Z. J. (2019). *Protein aggregation and mitigation strategy in low pH viral inactivation for monoclonal antibody purification*. *MAbs*, 11(8), 1479–1491. <https://doi.org/10.1080/19420862.2019.1658493>

- Joachin, R. (September 29, 2020). *Weighing the potential of Humira biosimilars in the U.S.* —*Competitive dynamics analysis*. Retrieved November 19, 2021, from <https://www.biosimilardevelopment.com/doc/weighing-the-potential-of-humira-biosimilars-in-the-u-s-competitive-dynamics-analysis-0001>
- Johnson, M. (2021). *Antibody storage and antibody shelf life*. Materials and Methods. <https://www.labome.com/method/Antibody-Storage-and-Antibody-Shelf-Life.html>
- Joshi, V., Shivach, T., Kumar, V., Yadav, N., & Rathore, A. (2014). *Avoiding antibody aggregation during processing: Establishing hold times*. *Biotechnology Journal*, 9(9), 1195–1205. <https://doi.org/10.1002/biot.201400052>
- Kanje, S., Scheffel, J., Nilvebrant, J., & Hober, S. (2020). *Engineering of protein A for improved purification of antibodies and fc-fused proteins*. *Approaches to the Purification, Analysis and Characterization of Antibody-Based Therapeutics*, 35-54. <https://doi.org/10.1016/B978-0-08-103019-6.00002-3>
- Kantarjian, H., Steensma, D., Rius Sanjuan, J., Elshaug, A., & Light, D. (2014). *High cancer drug prices in the United States: Reasons and proposed solutions*. *Journal of Oncology Practice*, 10(4), e208–e211. <https://doi.org/10.1200/JOP.2013.001351>
- Kelley, B. (2009). *Industrialization of mAb production technology: The bioprocessing industry at a crossroads*. *MAbs*, 1(5), 443–452.
- Kunert, R., & Reinhart, D. (2016). *Advances in recombinant antibody manufacturing*. *Applied microbiology and biotechnology*, 100(8), 3451–3461. <https://doi.org/10.1007/s00253-016-7388-9>
- L-Glutamine*. (2022). Sigma-Aldrich. <http://www.sigmaaldrich.com/>

- Lee, J. J., Yang, J., Lee, C., Moon, Y., Ahn, S., & Yang, J. (2019). *Demonstration of functional similarity of a biosimilar adalimumab SB5 to Humira®*. *Biologicals*, 58, 7–15.  
<https://doi.org/10.1016/j.biologicals.2018.12.002>
- Liu, H. F., Ma, J., Winter, C., & Bayer, R.. (2010). *Recovery and purification process development for monoclonal antibody production*. *Mabs*, 2(5), 480–499.  
<https://doi.org/10.4161/mabs.2.5.12645>
- López-Meza, J., Araíz-Hernández, D., Carrillo-Cocom, L. M., López-Pacheco, F., Rocha-Pizaña, M., & Alvarez, M. M. (2016). *Using simple models to describe the kinetics of growth, glucose consumption, and monoclonal antibody formation in naive and infliximab producer CHO cells*. *Cytotechnology*, 68(4), 1287–1300.  
<https://doi.org/10.1007/s10616-015-9889-2>
- Magenat, L., Palmese, A., Fremaux, C., D'Amici, F., Terlizze, M., Rossi, M., & Chevalet, L.. (2017). *Demonstration of physicochemical and functional similarity between the proposed biosimilar adalimumab MSB11022 and Humira®*. *Mabs*, 9(1), 127–139.  
<https://doi.org/10.1080/19420862.2016.1259046>
- Market gears up for biosimilar boom in 2023 as Humira® exclusivity draws to a close*. (2021, June 18). Healio. Retrieved November 25, 2021, from  
<https://www.healio.com/news/rheumatology/20210617/market-gears-up-for-biosimilar-boom-in-2023-as-humira-exclusivity-draws-to-a-close>
- Polysulfone average Mw 35,000 LS, average Mn 16,000 MO, pellets Transparent 25135-51-7*. (n.d.). Retrieved March 24, 2022, from <http://www.sigmaaldrich.com/>
- Martins, D. L., Sencar, J., Hammerschmidt, N., Flicker, A., Kindermann, J., Kreil, T. R., & Jungbauer, A. (2020). *Truly continuous low pH viral inactivation for biopharmaceutical*

*process integration*. *Biotechnology and Bioengineering*, 117(5), 1406–1417.

<https://doi.org/10.1002/bit.27292>

Mazzer, A. R., Perraud, X., Halley, J., O’Hara, J., & Bracewell, D. G. (2015). *Protein A chromatography increases monoclonal antibody aggregation rate during subsequent low pH virus inactivation hold*. *Journal of Chromatography. a*, 1415, 83–90.

<https://doi.org/10.1016/j.chroma.2015.08.068>

McKinney, N. (2018, September 27). *Cryopreservation of cells*. Retrieved November 25, 2021, from

[https://www.usp.org/sites/default/files/usp/document/our-work/biologics/resources/gc-1044-cryopreservation-of-cells.pdf?source=content\\_type%3Areact%7Cfirst\\_level\\_url%3Aarticle%7Csection%3Amain\\_content%7Cbutton%3Abody\\_link](https://www.usp.org/sites/default/files/usp/document/our-work/biologics/resources/gc-1044-cryopreservation-of-cells.pdf?source=content_type%3Areact%7Cfirst_level_url%3Aarticle%7Csection%3Amain_content%7Cbutton%3Abody_link).

*Medica® systems*. (2017). Evoqua.

[https://www.evoqua.com/siteassets/documents/products/high-purity-water-systems/medica\\_market\\_range\\_brochure\\_v\\_1.0.pdf](https://www.evoqua.com/siteassets/documents/products/high-purity-water-systems/medica_market_range_brochure_v_1.0.pdf)

Mendiratta, S. K., Bandyopadhyay, S., & SINGH, A. K. (2014). *Purification process for monoclonal antibodies* (World Intellectual Property Organization Patent No.

WO2014207763A1). <https://patents.google.com/patent/WO2014207763A1/en>

Merck KGaA. (2021a). *Hydrophobic Millipore Express® SPG gamma stable capsule filters*.

Millipore Sigma. Retrieved April 5, 2022, from

[https://www.emdmillipore.com/US/en/product/Hydrophobic-Millipore-Express-SPG-Gamma-Stable-Capsule-Filters,MM\\_NF-C104938?CatalogCategoryID=](https://www.emdmillipore.com/US/en/product/Hydrophobic-Millipore-Express-SPG-Gamma-Stable-Capsule-Filters,MM_NF-C104938?CatalogCategoryID=)

Merck KGaA. (2021b). *Millistak+® Pod disposable depth filter systems*. Millipore Sigma.

Retrieved March 14, 2022, from

[https://www.emdmillipore.com/US/en/product/Millistak-Pod-Disposable-Depth-Filter-Sy  
stems,MM\\_NF-C9485#documentation](https://www.emdmillipore.com/US/en/product/Millistak-Pod-Disposable-Depth-Filter-Systems,MM_NF-C9485#documentation)

Mikulic, M. (2021, March 26). *Top pharma products by global sales*. Statista.

[https://www.statista.com/statistics/258022/top-10-pharmaceutical-products-by-global-sal  
es-2011/](https://www.statista.com/statistics/258022/top-10-pharmaceutical-products-by-global-sales-2011/)

Nixon, T. (2022, February 15). *AKB: Web Registration* [Personal communication].

Nichols, B. (2022, March 29). *AKTApcc pricing* [Personal communication].

Pall Laboratories. (2021, February 17). *Diafiltration: A fast, efficient method for desalting, or*

*buffer exchange of biological samples*. Bioprocess Online. Retrieved February 18, 2022,  
from

[https://www.bioprocessonline.com/doc/diafiltration-a-fast-efficient-method-for-desalting-  
or-buffer-exchange-of-biological-samples-0001](https://www.bioprocessonline.com/doc/diafiltration-a-fast-efficient-method-for-desalting-or-buffer-exchange-of-biological-samples-0001)

Pall. (2022). *Virus inactivation*. Pall. Retrieved February 18, 2022, from

<https://www.pall.com/en/biotech/technologies/virus-safety/virus-inactivation.html>

PHCBI. (2021). *Cryogenic and ultra-low temperature freezers*. PHC Corporation of North

America. Retrieved from

[http://markitbiomedical.com/knowledge-center/files/11277\\_4\\_PHCBI\\_VIP\\_Brochure\\_vf.  
pdf.](http://markitbiomedical.com/knowledge-center/files/11277_4_PHCBI_VIP_Brochure_vf.pdf)

Pedersen, M. E., Haegebaert, R. M. S., Østergaard, J., & Jensen, H.. (2021). *Size-based*

*characterization of adalimumab and TNF- $\alpha$  interactions using flow induced dispersion*

*analysis: assessment of avidity-stabilized multiple bound species*. Scientific Reports,

11(1). <https://doi.org/10.1038/s41598-021-84113-z>

Peters, M. S., & Timmerhaus, K. D. (1991). *Plant design and economics for chemical engineers* (4th Edition). McGraw-Hill Publishing.

*Pharmaceutical operator salaries*. (2021, December 13). Glassdoor.

[https://www.glassdoor.com/Salaries/pharmaceutical-operator-salary-SRCH\\_KO0,23.htm](https://www.glassdoor.com/Salaries/pharmaceutical-operator-salary-SRCH_KO0,23.htm)

PHC corporation. (2021). *VIP ECO natural refrigerant -86°C upright freezer*.

<https://www.phchd.com/us/biomedical/preservation/ultra-low-freezers/mdf-du702vhpa>

*Phosphoric acid 1.0 molar*. (n.d.). Lab Alley. Retrieved March 26, 2022, from

<https://www.laballey.com/products/phosphoric-acid-1-0-molar>

*Planova™ 15N, 20N & 35N Virus Removal Filters*. (n.d.). Asahi Kasei Bioprocess. Retrieved

February 2, 2022, from

[https://planova.ak-bio.com/products\\_services/virus-removal/planova-n/](https://planova.ak-bio.com/products_services/virus-removal/planova-n/)

*Planova™ single-use virus filtration controller*. (n.d.). Asahi Kasei Bioprocess. Retrieved

February 14, 2022, from <https://fluidmgmt.ak-bio.com/products/su-vfc/>

*Polysorbate 80*. (2022). Millipore Sigma. <http://www.sigmaaldrich.com/>

Prpich, G. (Presenter). (2021). *Continuous bioreactor with recycle*. Lecture presented at

University of Virginia, Charlottesville.

Prpich, G. (Presenter). (2021). *Fed-batch reactors*. Lecture presented at University of Virginia,

Charlottesville.

Prpich, G. (Presenter). (2021). *Microbial growth kinetics*. Lecture presented at University of

Virginia, Charlottesville.

Prpich, G. (Presenter). (2021). *Oxygen transfer*. Lecture presented at University of Virginia,

Charlottesville.



*QUANTA-S steam sterilizable freeze dryers (SIP)*. (n.d.). Millrock Technology, Inc. Retrieved February 1, 2022, from <https://www.millrocktech.com/freeze-dryers-2/production-freeze-dryers/quanta-s-steam-sterilizable-freeze-dryers-sip/>

*Raiden standard 2 HP plate mount top entry mixer*. (2022). Mixer Direct. <https://www.mixerdirect.com/products/raiden-standard-2-hp-plate-mount-top-entry-mixer>

Raj, G. M., Priyadarshini, R., & Mathaiyan, J. (2015). *Drug patents and intellectual property rights*. *European Journal of Clinical Pharmacology*, 71(4), 403–409. <https://doi.org/10.1007/s00228-015-1811-5>

*Residential electricity & gas*. (2022). Just Energy. <https://justenergy.com/for-homes/>

*Reverse osmosis*. (2014). FDA. <https://www.fda.gov/inspections-compliance-enforcement-and-criminal-investigations/inspection-technical-guides/reverse-osmosis>

Rowland, C. (2020, January 8). *Why price of Humira keeps rising despite FDA approval of generic competition*. *Washington Post*. [https://www.washingtonpost.com/business/economy/why-humiras-price-keeps-rising-despite-fda-approval-of-generic-competition/2020/01/07/549ed0ce-2e3a-11ea-bcb3-ac6482c4a92f\\_story.html](https://www.washingtonpost.com/business/economy/why-humiras-price-keeps-rising-despite-fda-approval-of-generic-competition/2020/01/07/549ed0ce-2e3a-11ea-bcb3-ac6482c4a92f_story.html)

Sargent, B. (2020, August 22). *Perfusion bioreactors*. *Cell Culture Dish*. Retrieved November 24, 2021, from <https://cellculturedish.com/perfusion-bioreactors-with-so-much-to-offer-they-deserve-a-closer-look/>

Sarpawari, A., Barenie, R., Curfman, G., Darrow, J. J., & Kesselheim, A. S. (2019). *The US biosimilar market: Stunted growth and possible reforms*. *Clinical Pharmacology & Therapeutics*, 105(1), 92–100. <https://doi.org/10.1002/cpt.1285>

*Sartocon® slice disposable Hydrosart® cassette*. (2022). Sartorius. <https://www.sartorius.com/shop/ww/en/usd/products-bioprocess-crossflow-filters/sartocoon-slice-disposable-hydrosart-cassette/p/3061860701W--SW>

Schreiber, S., Yamamoto, K., Muniz, R., & Iwura, T.. (2020). *Physicochemical analysis and biological characterization of FKB327 as a biosimilar to adalimumab*. *Pharmacology Research & Perspectives*, 8(3). <https://doi.org/10.1002/prp2.604>

*Shipping and reconstitution FAQs*. (n.d.). Shenandoah Biotechnology, Inc. Retrieved February 14, 2022, from <https://www.shenandoah-bt.com/shipping-and-reconstitution-faqs.html>

*Sodium citrate*. (2022). Millipore Sigma. <http://www.sigmaaldrich.com/>

*Sodium hydroxide, laboratory grade, 2 kg*. (2022). Flinn Scientific. <https://www.flinnsci.com/sodium-hydroxide-laboratory-grade-2-kg/s0077/>

*Sodium phosphate*. (2022). Millipore Sigma. <http://www.sigmaaldrich.com/>

*Sodium phosphate dibasic dihydrate*. (2022). Millipore Sigma. <http://www.sigmaaldrich.com/>

*Sodium phosphate monobasic dihydrate*. (2022). Millipore Sigma. <http://www.sigmaaldrich.com/>

*Sterile water for injection*. (n.d.). U.S. Food and Drug Administration. [https://www.accessdata.fda.gov/drugsatfda\\_docs/label/2016/018632s051lbl.pdf](https://www.accessdata.fda.gov/drugsatfda_docs/label/2016/018632s051lbl.pdf)

Thermo Fisher Scientific. (2022). *Precision™ general purpose baths*. <https://www.thermofisher.com/order/catalog/product/TSGP02>

*The top 300 drugs of 2019*. (2021, August). ClinCalc. Retrieved November 19, 2021, from <https://clincalc.com/DrugStats/Top300Drugs.aspx>

Turton, R., Bailie, R. C., Whiting, W. B., Shaeiwitz, J. A., & Bhattacharyya, D. (2012). *Analysis, synthesis, and design of chemical processes* (4th Edition). Pearson.

<https://learning.oreilly.com/library/view/analysis-synthesis-and/9780132618724/>

U.S. Food and Drug Administration/Center for Drug Evaluation and Research. (2020). *Quality considerations for continuous manufacturing*.

<https://www.fda.gov/regulatory-information/search-fda-guidance-documents/quality-considerations-continuous-manufacturing>

U. S. Food and Drug Administration/Center for Drug Evaluation and Research. (2009a). *Q8(R2) pharmaceutical development*.

<https://www.fda.gov/regulatory-information/search-fda-guidance-documents/q8r2-pharmaceutical-development>

U. S. Food and Drug Administration/Center for Drug Evaluation and Research. (2006). *Q9 pharmaceutical risk management*.

<https://www.fda.gov/regulatory-information/search-fda-guidance-documents/q9-quality-risk-management>

U.S. Food and Drug Administration/Center for Drug Evaluation and Research. (2009b). *Q10 pharmaceutical quality system*.

<https://www.fda.gov/regulatory-information/search-fda-guidance-documents/q10-pharmaceutical-quality-system>

U.S. Food and Drug Administration/Center for Drug Evaluation and Research. (2011). *Process validation: General principles and practices*.

<https://www.fda.gov/regulatory-information/search-fda-guidance-documents/process-validation-general-principles-and-practices>

- U.S. Food and Drug Administration/Center for Drug Evaluation and Research. (2018). *Q11 development and manufacture of drug substances--Questions and answers (Chemical Entities and Biotechnological/Biological Entities)*.  
<https://www.fda.gov/regulatory-information/search-fda-guidance-documents/q11-development-and-manufacture-drug-substances-questions-and-answers-chemical-entities-and>
- Vaidya, M. (2021, February 19). *AbbVie's successful hard-ball with Humira legal strategy unlikely to spawn similar efforts; potential appeals outcome unclear*. Pharmaceutical Technology.  
<https://www.pharmaceutical-technology.com/comment/abbvies-successful-hard-ball-with-humira/>
- van Reis, R., & Zydney, A. (2007). Bioprocess membrane technology. *Journal of Membrane Science*, 297(1), 16–50. <https://doi.org/10.1016/j.memsci.2007.02.045>
- Water for injection (WFI)*. (2021). Evoqua.  
<https://www.evoqua.com/en/markets/applications/water-for-injection-wfi/>
- Williams, K. (2016, August 3). *How long will it take to freeze dry my samples?* Labconco.  
<https://www.labconco.com/articles/how-long-will-it-take-to-freeze-dry-my-samples>
- Wootla, B., Denic, A., & Rodriguez, M. (2014). *Polyclonal and monoclonal antibodies in clinic*. In M. Steinitz (Ed.), *Human Monoclonal Antibodies* (Vol. 1060, pp. 79–110). Humana Press. [https://doi.org/10.1007/978-1-62703-586-6\\_5](https://doi.org/10.1007/978-1-62703-586-6_5)
- Wrampe, J. (2019, July 8). *Membrane-based reverse osmosis systems for WFI production*.  
<https://www.pharmasalmanac.com/articles/membrane-based-reverse-osmosis-systems-for-wfi-production>

- Xu, J., Rehmann, M. S., Xu, M., Zheng, S., Hill, C., He, Q., Borys, M. C., & Li, Z. J.. (2020). *Development of an intensified fed-batch production platform with doubled titers using N-1 perfusion seed for cell culture manufacturing*. *Bioresources and Bioprocessing*, 7(1). <https://doi.org/10.1186/s40643-020-00304-y>
- Yang, O., Prabhu, S., & Ierapetritou, M.. (2019). *Comparison between batch and continuous monoclonal antibody production and economic analysis*. *Industrial & Engineering Chemistry Research*, 58(15), 5851–5863. <https://doi.org/10.1021/acs.iecr.8b04717>
- Yigzaw, Y., Piper, R., Tran, M. and Shukla, A.A. (2006), *Exploitation of the adsorptive properties of depth filters for host cell protein removal during monoclonal antibody purification*. *Biotechnol Progress*, 22: 288-296. <https://doi.org/10.1021/bp050274w>