

Engineers in Action: Coilolo River Pedestrian Bridge

A Technical Report submitted to the Department of Civil and Environmental Engineering

Presented to the Faculty of the School of Engineering and Applied Science
University of Virginia • Charlottesville, Virginia

In Partial Fulfillment of the Requirements for the Degree
Bachelor of Science, School of Engineering

John Hamby

Spring, 2023

Technical Project Team Members

Sarah Besecky

Glenn Broderick

Katherine Foley

Gabby Ford

Tim Maxwell

Terence Moriarty

Wyatt Yoder

On my honor as a University Student, I have neither given nor received unauthorized aid on this assignment as defined by the Honor Guidelines for Thesis-Related Assignments

Advisor

Jose Gomez, Department of Civil and Environmental Engineering

Capstone Design and Construction Report



ENGINEERS IN ACTION

Coilolo River Pedestrian Bridge

Capstone Report
Coilolo, Bolivia 2023
University of Virginia

Prepared by:

Project Manager
Gabby Ford
ghf4sec@virginia.edu

Design Engineer in Charge
Leo Fernandez, PE, PMP, DBIA
leo.fernandez@tylin.com

Faculty Advisor
Jose Gomez, PE, PhD
jpg4k@virginia.edu

Team Members (University of Virginia)

Sarah Besecky
Glenn Broderick
Katherine Foley
Gabby Ford
Cooper Hamby
Tim Maxwell
Terence Moriarty
Wyatt Yoder

Technical Advisors
Leo Fernandez, PE, PMP, DBIA
Rupa Patel, PE



EXECUTIVE SUMMARY

The Coilolo River Pedestrian Bridge Project aims to serve members of the Coilolo and Tipa Tipa communities, located in Coilolo, Jaime Zudáñez, Chuquisaca, Bolivia. The suspended footbridge design conforms to design criteria set in the Engineers in Action 2022 Bridge Binder Volume 2. The proposed bridge design spans a total distance of 57.8 meters (m) and consists of a customized BO-3G-60B abutment on the left bank and a customized BO-3G-60A abutment on the right bank. In order to meet anchor uplift requirements and reduce backfill volume, the left abutment was placed 3.6 m back from the left bank and was lengthened by 1.4 m. In addition, the right abutment was placed 3.0 m back from the right bank and the anchor was raised by 0.5 meters to provide a more efficient design and to prevent stability issues. In order to meet the floodplain freeboard requirement of 2.0 m, the left abutment was modified to incorporate a 1.5 m tall foundation. The difference between the tower saddle heights is 0.385 m, and the achieved freeboard is 2.15 m. Tier 1 design checks were initially performed on the bridge components to assure that basic failure modes were averted. Tier 2 design checks were then performed on the abutments and walkway structure components to determine if the custom abutment design would impact the safety of the bridge system. It was determined that the structural components met the required safety factors and requirements set by EIA in Bridge Binder Volume 2.

Capstone Report Checklist

The contents of this checklist must be completed before the team will receive a passing grade from the Engineers in Action staff and ensure the report contains necessary information for the building of this bridge project. The team and its reviewers should ensure that this checklist is complete before submission to Engineers in Action for review. By signing and dating below, reviewers give their professional word that the checklist is complete and accurate.

- Proof of report review by technical mentors, ambassadors, DEICs, and faculty advisor
- General report content and quality
- Statement on international development
- Labelled AutoCAD survey profile shown
- Calculations included (hand calcs and/or raw excel file)
- Drawing Set included and complete according to the [Drawings Checklist](#) found on BEDU
- Drawing Set created from EIA's "Suspended_Template.dwg" and "EIA.ctb" files
- Drawing Set meets country-specific requirements
- Consistent values between Drawing Set, calculations and general report
- CAD file with bridge elevation view
- Bill of Quantities
- Excavation Drawings
- Construction Schedule



Proof of Review

The contents of this report and all appendices must be proofed for errors, omissions, efficiency, and strong writing before it is submitted to Engineers in Action for Review. By signing and dating below, reviewers give their professional word that they have proofed the report and appendices in their entirety and have found them satisfactory for submission to Engineers in Action and use in a real-world engineering design-build project in the developing world. Reviewers should not sign until they feel the report and appendices meet their standards. If the report does not meet EIA's standards, the team will be assessed a \$500 "poor performance fine" as outlined in more detail in the Bridge Binder. Failure to secure the required reviews and accompanying signatures will also result in the poor performance fine.

The objective of this review system is to hold students accountable to doing excellent work and educate them on the level of performance that is required and expected of them when working on real-world engineering projects. Thank you for participating in this educational process.



Signature Page

Faculty Adviser (required):

By signing below, I certify that I reviewed the following according to the above requirements:

- Report and appendix content and quality (required)
- Design, Drawing Set, and associated calculations (required)
- Construction elements related to design and excavation drawings (required)

Name (printed): Jose Gomez

Signature: 

Date: 4/17/2023

Team Mentor (other than faculty adviser, recommended):

By signing below, I certify that I reviewed the following according to the above requirements:

- Report and appendix content and quality (recommended)
- Design, Drawing Set, and associated calculations (recommended)
- Construction elements related to design and excavation drawings (recommended)

Name (printed): Leo Fernandez and Rupa Patel

Signature: 

Date: 4/17/2023



Table of Contents

Capstone Design and Construction Report	1
Capstone Report Checklist	2
Proof of Review	3
Signature Page	4
1.0 Introduction	8
2.0 General Background	8
2.1 Project Development and Justification	8
2.2 Project Location	8
2.3 Horizontal and Vertical Clearances	9
2.4 Restrictions and Utility Conflicts	9
2.5 Material Acquisition	9
2.6 Roles and Responsibilities	10
2.7 Environmental Impact and Land Usage	10
2.8 Statement on International Development	11
3.0 Site Overview, Geotechnical, and Hydraulic Conditions	11
3.1 Topographic Survey	12
3.2 Site Photos	12
3.3 Site Specific Conditions	12
3.4 Existing Soil Conditions	12
3.5 Hydraulic Conditions and High Water Line	12
4.0 Structure (Standard Design)	15
4.1 Design Standards	15
4.2 Geometric Evaluation	15
4.3 Anchor Type and Location	17
4.4 Alternative Structure Type Comparison	18
4.5 Bridge Details	22
4.6 Concept Definition Call Follow-Up	23
5.0 Design Process (Custom Design)	23
5.1 Design Standards and Objectives	23
5.2 Left Side Anchor & Abutment Placement	25
5.3 Right Side Anchor & Abutment Placement	25
5.4 Geometric Conformance	26
5.5 Comparison of Alternatives	27
5.6 Design Checks	28
5.7 EIA Drawings Selection	31
6.0 Bill of Quantities	32
6.1 Quantity Take-Off	32
6.2 Equipment and Tools	35
7.0 Construction Plan	37
7.1 Excavation Drawings	37
7.2 Construction Schedule	38
7.3 Quality Control Sign Offs	41



7.4 Challenging Design and Constructability Elements	44
Design and Construction Call Follow-Up	44
Appendix A: Site Information	45
A.1 Maps	45
A.2 Media	46
A.2a Downstream	46
A.2b Upstream	47
A.2c Left Bank, Towards River	48
A.2d Left Bank, Away	49
A.2e Right Bank, Towards River	50
A.2f Right Bank, Away	51
A.3 Autocad Survey Profile	52
A.4 Project Assessment	53
A.5 Technical Survey Form	60
Appendix B: Draft Agreement for the Coilolo River Pedestrian Bridge	63
B.1 In Country Manager Material List	63
Appendix C: Design Calculations	64
C.1 Loads Calculations	64
C.2 Cable Analysis and Design	67
C.3 Walkway Analysis	70
C.4 Tower and Foundation Analysis	70
C.5 Anchor Analysis	74
C.6 Superstructure	80
C.7 Construction	86
C.8 Additional Checks	90
Appendix D: Drawing Set	91
D.1 Title + General Notes	91
D.2 Layout	92
D.3 Left Abutment Details	93
D.4 Right Abutment Details	94
D.5 Anchor Details	95
D.6 Tower Details	96
D.7 Walkway Details	97
D.8 Steel Crossbeam Details	98
D.9 Approach Ramp Details	99
Appendix E: Construction Plan	100
E.1 Excavation Drawings	100
E.2 Construction Schedule	102
E.3 Work Breakdown Structure	111
E.4 EIA Bridge Project Comparisons - Activity Duration Estimates	112



Table of Figures

Figure 2.2.1. Plan View of Bridge Site.	8
Figure 2.5.1. Stakeholder Roles, Responsibilities and Contributions.	10
Figure 3.0.1. Plan View of Bridge Site.	11
Figure 3.5.1. Upstream.	12
Figure 3.5.2. Across to Right Bank.	12
Figure 3.5.3. Across to Left Bank.	12
Figure 3.5.4. Hydrological Map of Bolivia.	13
Figure 3.5.5. Coilolo River Site High Water Line.	13
Figure 3.5.6. September 2002.	14
Figure 3.5.7. August 2016.	14
Figure 3.5.8. June 2017.	14
Figure 3.5.9. July 2018.	14
Figure 3.5.10. October 2020.	14
Figure 4.2.1. Standard Design Requirements from EIA.	15
Figure 4.2.2. Initial Geometric Design Layout.	15
Figure 4.2.3. Design #1 Non-Standard Geometric Layout.	17
Figure 4.4.1. Design #2 Standard Geometric Layout.	18

Table of Tables

Table 4.2.1. Proposed Design Geometric Requirements Summary.	16
Table 4.2.2. Non-Standard Proposed Design Geometric Requirements Summary.	17
Table 4.4.1. Design #2 Geometric Requirements Summary.	18
Table 4.4.2. Detailed BOQ and Cost Estimate for Design Option #1.	19
Table 4.4.3. Detailed BOQ and Cost Estimate for Design Option #2.	20
Table 4.4.4. Design #1 Standard Cable Design Check.	21
Table 4.4.5. Design #2 Standard Cable Design Check.	21
Table 4.4.6. Excavation Comparison Between Design #1 and Design #2.	21
Table 4.5.1. Summary of Achieved Factors of Safety for Standard Design Checks.	22
Table 4.6.1. Action Items from Concept Definition Call.	23
Table 5.4.1. Geometric Conformance Summary.	26
Table 5.6.1. Safety Factor Checklist	28
Table 5.6.2. Clamp Number, Spacing, and Torque Requirements.	29
Table 5.6.3. Sag Values and Percentages.	29
Table 6.1.1. Variable Construction Material BOQ.	32
Table 6.1.2. Static Construction Material BOQ.	33
Table 6.1.3. Material BOQ Discrepancy Report.	34
Table 6.2.1. Equipment and Tool Requirements for Bridge Construction.	36
Table 7.2.1. Construction Schedule Summary.	38
Table 7.2.2. Float Activities.	39
Table 7.3.1. Construction Quality Control Concerns.	41
Table 7.4.1. Action Items from Review Call 2.	44

1.0 Introduction

This Report will serve as a type, size, and location study for a pedestrian bridge crossing the Coilolo River and linking the Coilolo and Tipa Tipa communities in Bolivia.

2.0 General Background

2.1 Project Development and Justification

This project aims to serve members of the Coilolo and Tipa Tipa communities, which are located in the Jaime Zudáñez province in the Bolivian department of Chuquisaca. The population of these communities amounts to approximately 800 inhabitants, and the main sources of economic activity include agriculture and raising domestic livestock. In terms of local infrastructure, there is one school in the village of Coilolo (located on the west side of the Coilolo River). There are also multiple schools, health centers, and markets in the nearby town of Zudáñez (located 7 kilometers (km) northwest of Coilolo). A large portion of the agricultural fields and homes that comprise these communities are located on the east side of the Coilolo River, and thus community members who work and reside on this side remain isolated from the previously described local infrastructure during the rainy season, which persists for six months of a given year. This subsequently impacts the access to school, healthcare, and agricultural and livestock markets during this time, as it is difficult to cross the Coilolo River and reach the village and town centers of Coilolo and Zudáñez.

2.2 Project Location

This project will be located in Coilolo, Jaime Zudáñez, Chuquisaca, Bolivia. The Coilolo River flows northwest through central Bolivia and borders both the village of Coilolo and the neighboring town of Zudáñez on the east. The proposed footbridge site is located 1 km southeast from the direct beneficiary community of Coilolo and 7 km southeast from the town of Zudáñez. The proposed bridge alignment and location are shown in Figure 2.2.1 below; the western bridge abutment will lie adjacent to agricultural land, while the eastern abutment will impact a portion of a community soccer field.

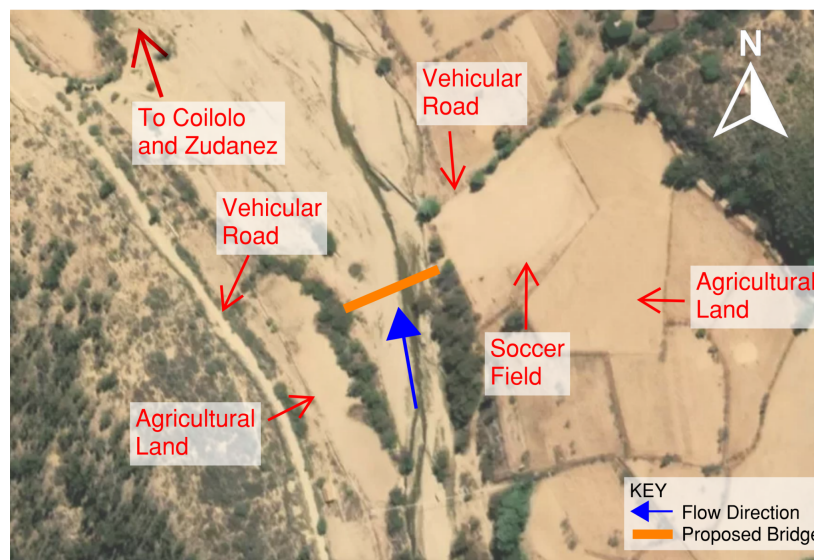

Figure 2.2.1. Plan View of Bridge Site.



2.3 Horizontal and Vertical Clearances

On the southwest side of the proposed bridge location, there is little vegetation and the land is flat for both horizontal and vertical clearances. On the northeast side of the proposed bridge site, the land is flat; however, there are two molle trees and a soccer goal post which will need to be removed or relocated prior to construction. There are no other clearance issues to be considered for this site.

2.4 Restrictions and Utility Conflicts

No information has been provided that suggests that there are any sewer, electrical, or potable water lines present in the construction area. If any indication of utilities becomes apparent to the team, this will be immediately communicated to the technical advisors to ensure the preservation of the utility lines and determine how to proceed with design and construction.

2.5 Material Acquisition

Figure 2.5.1 below outlines the roles of each respective stakeholder, including information about what their responsibilities are and what contributions they will make to the pedestrian bridge project. Material acquisition planning will follow along with this table, which was provided by Bridges to Prosperity (B2P) and Engineers in Action (EIA) in the Bridge Builder Manual. According to the Financing Agreement for the execution of the project (see Appendix A.6), the main parties involved in material acquisition for this project are the Engineers in Action Foundation, the Autonomous Municipal Government of Zudáñez, and the Community of Coilolo. EIA will provide the clamps and steel cables needed for the project. The Municipal Government of Zudáñez will be responsible for purchasing the reinforcing steel, cement, sand, gravel, and hardwood. They will also be responsible for providing machinery and heavy equipment for cleaning, debris removal, excavation of land, laying of cables, and other work on the site, including arranging the transportation for the delivery of local and non-local materials. The community of Coilolo will be responsible for purchasing and/or collecting the stone for the project.

According to the Project Social Assessment (see Appendix A.4), the local materials that exist on the site and in nearby communities are stone, sand, and gravel. The local community of Coilolo will be responsible for collecting the materials purchased for them already on site and for performing most of the day-to-day construction activities. There is a main road that runs along the left bank of the river that stretches to Zudáñez to the north and Marcani to the south. This road is substantial enough that any materials coming from either town will be able to be transported by light truck or other vehicles.



Table 2.1 – Key Stakeholder Roles, Responsibilities, and Contributions

Local Government		
Role	Responsibilities	Contribution
Lead project and support community	<ul style="list-style-type: none"> • Purchase of materials not available for collection • Transportation of materials • Heavy machinery work • Legal support 	<ul style="list-style-type: none"> • Skilled labor • Purchased sand • Purchased gravel • Purchased stone • Purchased timber • Cement • Reinforcing steel • Fencing
Community and Bridge Committee		
Role	Responsibilities	Contribution
Build and maintain bridge	<ul style="list-style-type: none"> • Organization of work groups • Resolution of community related issues • Organize community contributions • Collection of local materials • Site Prep • Material Storage • Accommodation & food for any B2P staff on site 	<ul style="list-style-type: none"> • Unskilled labor • Collected sand • Collected gravel • Collected stone • Collected timber
B2P or Other Qualified Partner		
Role	Responsibilities	Contribution
Facilitate and supervise project	<ul style="list-style-type: none"> • Engineering services/bridge design • Construction supervision • Acquisition of materials not available in country 	<ul style="list-style-type: none"> • Construction drawings • Experienced construction supervisors • Cables and clamps • Steel towers (if applicable) • Steel crossbeams (if applicable)
Partner Organization		
Role	Responsibilities	Contribution
Support community in implementation of bridge project	Any of the responsibilities of the other three key stakeholders as agreed upon by all key stakeholders and based on organization's experience and strengths	Any of the contributions from other three key stakeholders dependent upon the agreed responsibilities

Figure 2.5.1. Stakeholder Roles, Responsibilities and Contributions.

2.6 Roles and Responsibilities

The university team is responsible for the complete design of the bridge and the construction plan. The role of the technical advisor is to provide design support, complete quality control sign-offs, and review reports. The community is responsible for providing laborers as well as the materials listed above in Figure 2.5.1. The role of EIA includes site identification and selection, material procurement, and supplying skilled laborers, tools, and equipment.

2.7 Environmental Impact and Land Usage

ENVIRONMENTAL IMPACT

The construction of the Coilolo River suspended footbridge will likely impact the natural environment on and surrounding the construction site. During the construction process, it is likely that the in-situ soil will be disrupted and the nearby vegetation, including two trees, will be removed. In an attempt to minimize the impact that these disturbances will have on site erosion and runoff, the project construction team must be cautious when performing work near the riverbanks.

In addition to considering the land and vegetation disturbances that the construction of the Coilolo River suspended footbridge may cause, environmental impacts resulting from the mixing and installation of concrete must also be considered. The construction team must be conscious of the spoils and corresponding contaminated water that results from mixing concrete, and these materials must be collected and disposed of at a location far from the river and agricultural land.

LAND OWNERSHIP

The selected site for the bridge would be located between a soccer field to the right and agricultural land to the left. The construction of the bridge would affect part of the soccer field, and the community is aware of this ramification. There is a vehicular dirt road adjacent to the soccer field that can be accessed by light trucks and vehicles. The agricultural land has little vegetation, and the homesteads are far from the site. There are no foreseeable land ownership issues. Donation certificates from affected landowners have been or will be acquired by EIA.

2.8 Statement on International Development

The team is taking an informed, conscientious approach with a well-rounded understanding of the positive and negative aspects of international development. We recognize that this is an opportunity for mutual benefit, with the Coilolo community gaining a vital resource, the footbridge, and the university team gaining exposure to expand our horizons by immersing ourselves in the Bolivian culture. The project serves to aid the community by providing resources that they would otherwise be unable to obtain.

3.0 Site Overview, Geotechnical, and Hydraulic Conditions

Figure 3.0.1 depicts a plan view of the bridge site (coordinates: -19.166861, -64.670142), adopting the EIA conventions for left and right banks. Given that the river is flowing northwest, the right bank is located to the north of the river and the left bank is located to the south of the river. The proposed bridge site will be located just 1 km from the Community of Coilolo, Bolivia and about 7 km from the nearest city, Zudáñez.

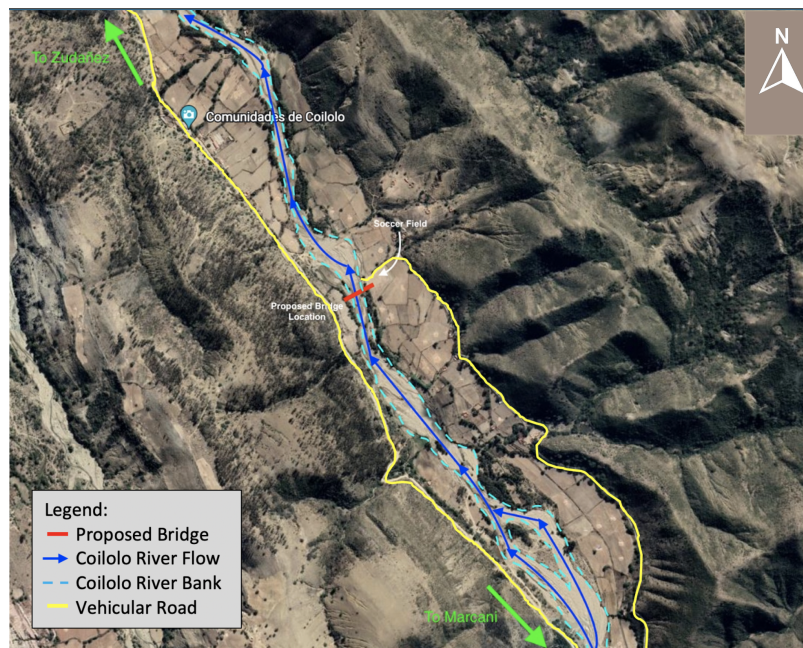

Figure 3.0.1. Plan View of Bridge Site.



3.1 Topographic Survey

The topographic survey was completed by Richar Galvez in March of 2022 along with a technical report of the survey. The data was processed by EIA and was provided to the team via AutoCAD along with supplementary photo and video data. Original survey data and the AutoCAD survey profile generated can be found in the Site Info folder on Google Drive along with photos and videos.

3.2 Site Photos

In accordance with the site documentation requirements set forth in the Technical Survey Form, a series of site photos are provided in Appendix A.

3.3 Site Specific Conditions

From the Technical Assessment of the bridge site (see Appendix A.5), there are a few notable obstructions to the construction of the bridge. There is little vegetation to the left side of the river and no obstructions have been noted. To the right side of the river, there are two molle trees that will need to be cut down before the start of construction. There are a number of additional bushes and trees upstream and downstream of the bridge site, but they will not affect the construction of the bridge. The two vehicular roads located in close proximity to the bridge site do not require rerouting. There are no known site constraints, such as power lines, utilities, or land ownership issues, impacting the bridge design based on the site-specific information provided by EIA.

3.4 Existing Soil Conditions

The left side of the river consists of all coarse-grained (gravel soil and sandy) soils. The right side of the river consists of both coarse-grained (sandy) and fine-grained (clayey) soils.

3.5 Hydraulic Conditions and High Water Line

RIVER CLASSIFICATION

The river and the area surrounding is more characteristic of a floodplain than a gorge. As seen in Figures 3.5.1, 3.5.2, and 3.5.3, the slight change in elevation, about 1.1 m on the right and 0.6 m on the left between the high water line and the edge of the bank does not allow for the river to rise vertically during a flood. Instead, the river overflows into the adjacent trail. Information from the local community suggests that the adjacent trail becomes submerged in about 0.39 m of water during a flood, indicating a horizontal spread of the river. The suspended footbridge will be designed to meet the specifications of a floodplain, with 2.0 m of freeboard.



Figure 3.5.1. Upstream.



Figure 3.5.2. Across to Right Bank.



Figure 3.5.3. Across to Left Bank.



HISTORIC HIGH WATER LINES

Bolivia is broken up into three main basins: the Altiplano, the Amazon, and the La Plata. Coilolo La Tipa Tipa, the project site, falls within the Amazon basin. As a segment of the Amazon basin, the water ultimately flows from the Amazon River. The Amazon basin and, therefore, the Coilolo River, discharges into the Atlantic Ocean. A breakdown of the Bolivian watersheds is shown in Figure 3.5.4 below.

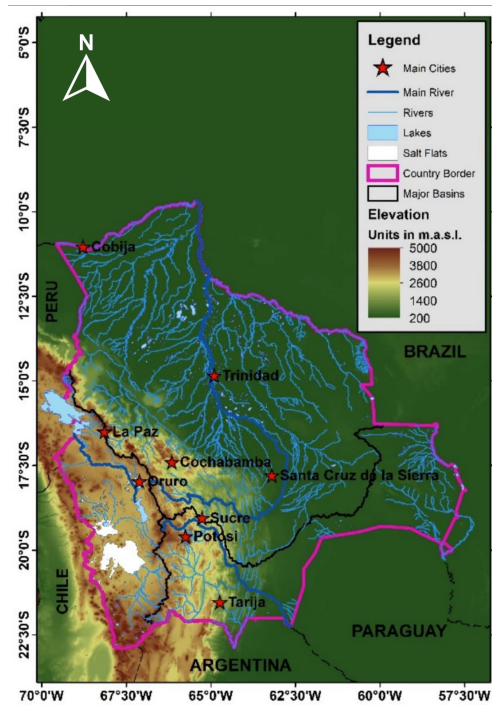

Figure 3.5.4. Hydrological Map of Bolivia (Saavedra et. al., 2022).

The Coilolo River is located in the Amazon basin and is most directly fed by the Rio Grande O Guapay. The only data found for high water lines at the location of the footbridge site are the Google Earth images that show changes over time in the Coilolo River. While there is not any quantitative data on historical floods on the Coilolo River, as it is more of a stream during the dry season, there is quantitative flood data for the Rio Grande O Guapay. During December of 2015, heavy rains caused the Rio Grande O Guapay to rise 6 m, which was 3 m above the previously record alert levels. The flooding caused by the rains at this time is described as the worst in 50 years (Floodlist News, 2015). The high water line for the Coilolo River used in this project was determined qualitatively by members of the community and is detailed in Figure 3.5.5 below. The water line is about 0.5 m above the bottom of the river.

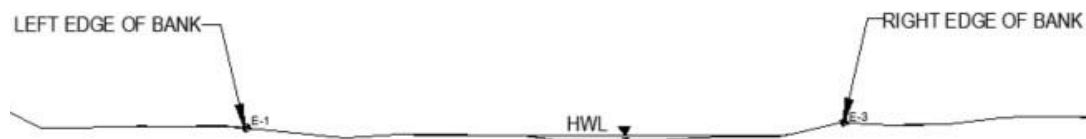

Figure 3.5.5 Coilolo River Site High Water Line.

Changes over time in the Coilolo River can be viewed from the Google Earth images in Figures 3.5.6-10 below from September, 2002, to October, 2020. The most notable change involves the location and abundance of vegetation. From Figure 3.5.6 to Figure 3.5.7, the vegetation decreases, particularly towards the northwest region of the channel. This decrease in vegetation is due to particularly intense flooding during this time period. The vegetation stays relatively stagnant between Figures 3.5.7, 3.5.8, and 3.5.9 before increasing in quantity in Figure 3.5.10.



Figure 3.5.6. September 2002.



Figure 3.5.7. August 2016.



Figure 3.5.8. June 2017.

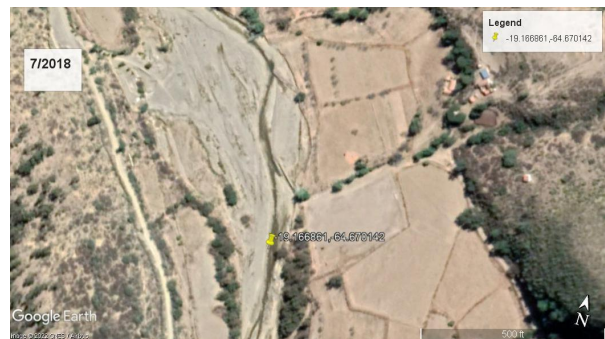

Figure 3.5.9. July 2018.

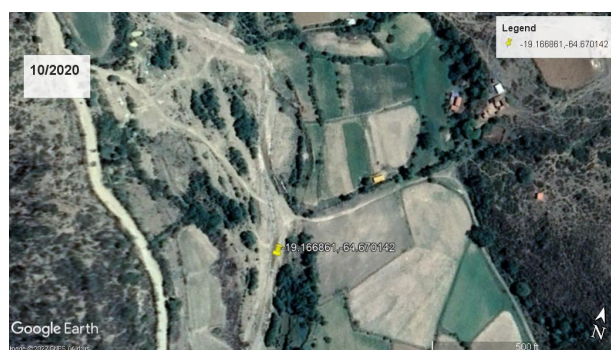

Figure 3.5.10. October 2020.



4.0 Structure (Standard Design)

4.1 Design Standards

Site approval and bridge type selection will conform to the following design criteria: Engineers in Action 2022 Bridge Binder Volume 2. It should be noted that the design checks described in this section were performed on standard abutment checks early in the design process and the results of this section were used to update and customize the design. Updated checks on the finalized non-standard design were performed and described in Section 5, so any design failures or inefficiencies found in this section are addressed there.

4.2 Geometric Evaluation

The geometric constraints applied to the bridge profile align with the requirements set by EIA for a standard bridge design, shown in Figure 4.2.1 below. As described in Section 3.5, the site is designated as a floodplain; therefore, the corresponding freeboard requirement of 2.0 m was applied to our design.

DESIGN REQUIREMENTS
Foundation must be 3.0 m from the edge of bank in soil.
Maximum span is 120 m.
Foundation must be placed behind an angle of internal friction of at least 35 degrees in soil.
The ground profile slope must be less than 10 degrees.
The height difference between cable saddles shall not exceed 4% of the span.
The minimum walkway cable saddle elevation above the ground is 1.4 m and the maximum elevation is 3.4 m.
Freeboard for a floodplain is a minimum of 2.0 m, for gorges is a minimum of 3.0 m.
Keep the foundations out of the floodplain.

Figure 4.2.1. Standard Design Requirements From EIA.

Once applied to our profile, shown in Figure 4.2.2, all but two of these standard design requirements were met (see Table 1 below). Even with the updated freeboard requirements for the flood plain designation, our initial standard design did not reach the 2.0 m requirement. In addition, the ground profile slope for the left abutment, at 28.79 degrees, exceeds the maximum of 10 degrees for abutments in soil.

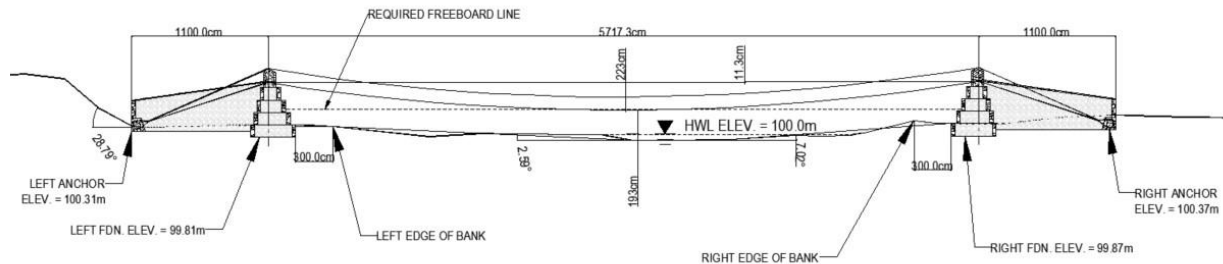

Figure 4.2.2. Initial Geometric Design Layout.

Table 4.2.1. Proposed Design Geometric Requirements Summary.

Variable	Value	Units	Limit	Units	Check
Left Foundation Setback	3	m	3	m	OK
Right Foundation Setback	3	m	3	m	OK
Left Fdn Behind Angle of Friction	2.59	deg	35	deg	OK
Right Fdn Behind Angle of Friction	7.02	deg	35	deg	OK
Span	57.2	m	120	m	OK
Delta H	0.113	m	2.29	m	OK
Left Side Ground Profile Slope	28.79	deg	10	deg	NG
Right Side Ground Profile Slope	0	deg	10	deg	OK
Left No. of Tiers	3	ea	3	ea	OK
Right No. of Tiers	3	ea	3	ea	OK
h_DL	2.29	m			
f	2.23	m			
Elevation of Low Side Walkway	104.16	m			
HWL	100.00	m			
Calculated Fb	1.93	m	2	m	NG

Following the analysis of several other design options that would conform to the standard design requirements, the decision to deviate from these requirements in our selected design was made to minimize bridge span and excavation. To meet the floodplain freeboard requirement of 2.0 m, a non-standard abutment with a foundation height of 1.5 m will be needed on the left side. The Tier 2 design checks and adjustments necessary for the analysis of an abutment with a 1.5 m tall foundation are included in Section 5 below. However, for the purposes of analyzing design conformance to the freeboard geometric requirement, we have determined that the increase in foundation height will sufficiently increase the freeboard to 2.18 m.

In addition to increasing the left abutment foundation from 1.0 m to 1.5 m tall, backfill behind the left abutment will also likely be needed to address the ground profile slope requirement noncompliance and to ensure anchor integrity. This will also be included in the Review Call #2 Design Report.

Figure 4.2.3 shows our selected geometric bridge design layout, while Table 2 displays the geometric design requirements that have been met by our design. The standard abutment BO-3G-60B was selected for use as the baseline left abutment, while the standard abutment BO-3G-60A was selected as the right abutment. As mentioned, the left baseline abutment will be modified in order to meet the freeboard and design check requirements. This foundation height change to 1.5 m is reflected in Figure 4.2.3 to better display how the geometric requirements are met. The freeboard with this adjusted abutment foundation on the left side, measured from the lowest point of the bridge to the Coilolo River high water line, is 2.18 m. Each abutment sits 3.0 m back from the respective edges of the bank, and the difference in tower saddle height is 0.403 m. Standard T4 towers will be used to accommodate the four (4) cables in the proposed design.

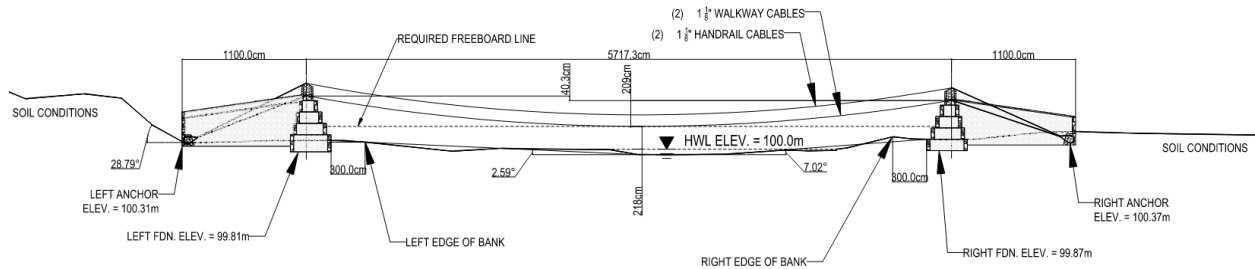

Figure 4.2.3. Design #1 Non-Standard Geometric Layout.

Table 4.2.2. Non-Standard Proposed Design Geometric Requirements Summary.

Variable	Value	Units	Limit	Units	Check
Left Foundation Setback	3	m	3	m	OK
Right Foundation Setback	3	m	3	m	OK
Left Fdn Behind Angle of Friction	2.59	deg	35	deg	OK
Right Fdn Behind Angle of Friction	7.02	deg	35	deg	OK
Span	57.2	m	120	m	OK
Delta H	0.403	m	2.29	m	OK
Left Side Ground Profile Slope	28.79	deg	10	deg	NG
Right Side Ground Profile Slope	0	deg	10	deg	OK
Left No. of Tiers	3	ea	3	ea	OK
Right No. of Tiers	3	ea	3	ea	OK
h_DL	2.29	m			
f	2.09	m			
Elevation of Low Side Walkway	104.27	m			
HWL	100.00	m			
Calculated Fb	2.18	m	2	m	OK

4.3 Anchor Type and Location

The two factors that must be considered when selecting the standard anchor details for the bridge design include the bridge's span length and the number of walkway cables. It was determined through the preliminary cable analysis that a total of four (4) 1 1/8" diameter cables (two handrail and two walkway cables) will be required to withstand the dead and live load combination for a 57.2 m bridge span (see Appendix 5.5b). Therefore, the standard A4 anchor, which is designed for 20 to 60 m span bridges with two (2) walkway cables, should be sufficient for use in the selected abutments (BO-3G-60B for the left bank and BO-3G-60A for the right bank).



4.4 Alternative Structure Type Comparison

To improve constructability and reduce cost, our team analyzed additional design alternatives prior to selecting the non-standard abutment option described in section 4.2 above. In particular, our team considered moving the left abutment to the top of the adjacent hillside, shown in Figure 4.4.1 below.

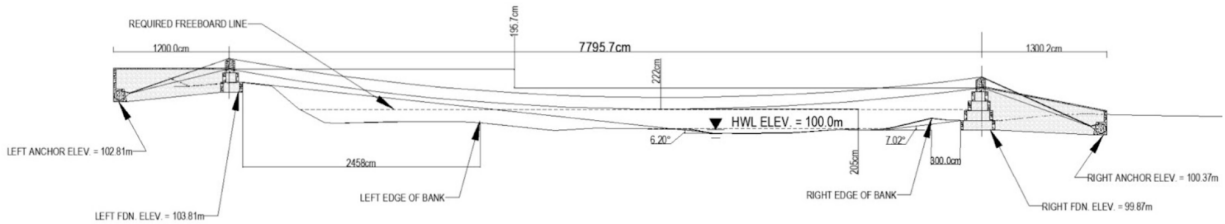

Figure 4.4.1. Design #2 Standard Geometric Layout.

This change resulted in a span length of 77.96 m and allowed for the use of the standard BO-1G-80B and BO-3G-80A abutments on the left and right banks, respectively. With a resulting freeboard value of 2.05 m, this design option satisfies the floodplain freeboard requirement without the use of a non-standard, 1.5 m tall abutment foundation. Table 3 below outlines the remaining geometric requirements that are met by this design option.

Table 4.4.1. Design #2 Geometric Requirements Summary.

Variable	Value	Units	Limit	Units	Check
Left Foundation Setback	3	m	3	m	OK
Right Foundation Setback	3	m	3	m	OK
Left Fdn Behind Angle of Friction	6.2	deg	35	deg	OK
Right Fdn Behind Angle of Friction	7	deg	35	deg	OK
Span	78.0	m	120	m	OK
Delta H	1.96	m	3.12	m	OK
Left Side Ground Profile Slope	10	deg	10	deg	OK
Right Side Ground Profile Slope	0	deg	10	deg	OK
Left No. of Tiers	1	ea	3	ea	OK
Right No. of Tiers	3	ea	3	ea	OK
h _{DL}	3.12	m			
f	2.22	m			
Elevation of Low Side Walkway	104.27	m			
HWL	100.00	m			
Calculated Fb	2.05	m	2	m	OK

* Assumed left ground profile slope of (maximum) 10 degrees. Survey limits do not include data to validate this assumption; however, this approximation is most conservative

Although design option #2 is advantageous in that it eliminates the need to utilize 1.5 m tall foundations, a detailed cost analysis of the major building components for both design options has allowed us to eliminate option #2 from consideration. Tables 4.4.2 and 4.4.3 below depict the detailed BOQ estimates for design options #1 and #2, respectively. Unit costs were estimated through an analysis of the draft agreement for the financing and execution of the Coilolo River Pedestrian Bridge, included in Appendix B.1.



Table 4.4.2. Detailed BOQ and Cost Estimate for Design Option #1.

Description		Left Abutment	Left Tower	Walkway	Right Abutment	Right Tower	Total Needed	Contingency Factor	TOTAL	Unit Cost	Total Cost
CABLE											
cable	m			396			396	1	396	\$49.50	\$19,603.58
CLAMP											
Abrazadera Forjado	unit			48			48	1.05	50.40	\$27.00	\$1,360.80
TIMBER											
Madera Dura (200x20x5cm)	unit			143			143	1.08	154.44	\$16.95	\$2,617.76
TIMBER NAILER											
Madera Dura (100x20x5cm)	unit			58.2			58.2	1.08	62.86	\$9.75	\$612.85
CROSSBEAM											
Perfil U 4x5, 4 lb/ft	6m bar			58.2			58.2	1.04	60.53	\$83.25	\$5,038.96
SCREW (timber)											
Tirafondo 3/8" x 3 1/2"	unit			858			858	1.25	1072.50	\$0.20	\$209.14
SCREW (timber nailer)											
Tiradondo 3/8" x 2"	unit			232.8			232.8	1.18	274.70	\$0.17	\$45.33
FENCING											
Malla O Galv. N 10 Alt 1.2 m	m^2			137.28			137.28	1.05	144.14	\$5.55	\$800.00
ROCK											
Piedra Bolon	m^3	139.23			147.21		286.43	1.05	300.75	\$7.50	\$2,255.66
TUBING											
Manguera de Succion de 3"	m	7.5			7.5		15	1.1	16.50	\$10.50	\$173.25
CEMENT											
Cemento Portland (50 kg bolsa)	50kg bag	188.95	7.56		204.10	7.56	408.17	1.13	461.23	\$7.80	\$3,597.63
SAND											
Arena	m^3	52.74	0.648		56.17	0.648	110.21	1.09	120.13	\$25.50	\$3,063.19
GRAVEL											
Grava Lavada	m^3	4.60	0.648		5.18	0.648	11.07	1.05	11.63	\$40.50	\$470.94
REBAR (#4)											
Acero Corrugado 1/2" (12mmx12m)	12m bar	30.00			30.00		60.00	1.05	63.00	\$13.35	\$841.05
REBAR (#5)*											
Acero Corrugado 5/8" (16mmx12m)	12m bar	6.00	24.00		0	24.00	54.00	1.05	56.70	\$23.25	\$1,318.28
REBAR (#6)											
Acero Corrugado 3/4" (20mmx12m)	12m bar	12.00			12.00		24.00	1.05	25.20	\$38.40	\$967.68
REBAR (#3)											
Acero Corrugado 3/8" (10mmx12m)	12m bar		16.63	349		16.63	382.46	1.05	401.59	\$8.70	\$3,493.80
PLASTIC HOSE											
Tuberia de Alta Densidad de 2"	m		3.3			3.3	6.60	1.1	7.26	\$2.10	\$15.25
BRICK											
Ladrillo Gambote 18H 25x12x6cm	unit		545			545	1090	1.02	1111.80	\$0.17	\$183.45
									TOTAL		\$46,668.57



Table 4.4.3. Detailed BOQ and Cost Estimate for Design Option #2.

Description		Left Abutment	Left Tower	Walkway	Right Abutment	Right Tower	Total Needed	Contingency Factor	TOTAL	Unit Cost	Total Cost
CABLE											
cable	m			608.5			609	1	609	\$49.50	\$30,120.75
CLAMP											
Abrazadera Forjado	unit			60			60	1.05	63.00	\$27.00	\$1,701.00
TIMBER											
Madera Dura (200x20x5cm)	unit			195			195	1.08	210.60	\$16.95	\$3,569.67
TIMBER NAILER											
Madera Dura (100x20x5cm)	unit			79			79	1.08	85.32	\$9.75	\$831.87
CROSSBEAM											
Perfil U 4x5, 4 lb/ft	6m bar			79			79	1.04	82.16	\$83.25	\$6,839.82
SCREW (timber)											
Tirafondo 3/8" x 3 1/2"	unit			1170			1170	1.25	1462.50	\$0.20	\$285.19
SCREW (timber nailer)											
Tiradondo 3/8" x 2"	unit			316			316	1.18	372.88	\$0.17	\$61.53
FENCING											
Malla O Galv. N 10 Alt 1.2 m	m^2			187.2			187.2	1.05	196.56	\$5.55	\$1,090.91
ROCK											
Piedra Bolon	m^3	84.70			133.53		218.23	1.05	229.14	\$7.50	\$1,718.55
TUBING											
Manguera de Succion de 3"	m	10.2			10.2		20.4	1.1	22.44	\$10.50	\$235.62
CEMENT											
Cemento Portland (50 kg bolsa)	50kg bag	148.53	7.56		212.34	7.56	375.98	1.13	424.86	\$7.80	\$3,313.90
SAND											
Arena	m^3	34.67	0.648		53.76	0.648	89.73	1.09	97.80	\$25.50	\$2,493.99
GRAVEL											
Grava Lavada	m^3	6.06	0.648		6.40	0.648	13.75	1.05	14.44	\$40.50	\$584.87
REBAR (#4)											
Acero Corrugado 1/2" (12mmx12m)	12m bar	60.00			60.00		120.00	1.05	126.00	\$13.35	\$1,682.10
REBAR (#5)*											
Acero Corrugado 5/8" (16mmx12m)	12m bar	18.00	24.00		0	24.00	66.00	1.05	69.30	\$23.25	\$1,611.23
REBAR (#6)											
Acero Corrugado 3/4" (20mmx12m)	12m bar	30.00			30.00		60.00	1.05	63.00	\$38.40	\$2,419.20
REBAR (#3)											
Acero Corrugado 3/8" (10mmx12m)	12m bar		16.95	474		16.95	507.89	1.05	533.29	\$8.70	\$4,639.62
PLASTIC HOSE											
Tuberia de Alta Densidad de 2"	m		3.3			3.3	6.60	1.1	7.26	\$2.10	\$15.25
BRICK											
Ladrillo Gambote 18H 25x12x6cm	unit		545			545	1090	1.02	1111.80	\$0.17	\$183.45
									TOTAL		\$63,398.50



This cost analysis shows a difference of \$16,729.90 between the two design options, with design option #2 as the more expensive option. The resulting cost discrepancy can mainly be attributed to the difference in cable costs (\$10,517.20) between the two options. The increased span length of design option #2 did not simply result in a linear increase in the cable quantity (and subsequently total project cost). Instead, as shown in Tables 4.4.4 and 4.4.5 below, our team determined that the increase in span length from 57.2 m to 77.96 m resulted in the requirement to use five (5) 1 1/8" diameter cables for design option #2 as opposed to the four (4) cables required for option #1. This component contributed most significantly to the difference in cost between both design options.

Table 4.4.4. Design #1 Standard Cable Design Check.

Max Force (Ps)	641.65	kN
Safety Factor	3	
# of Cables (n)	4	
Pu	492	kN
FScalc	3.067086	
Span Length	57.2	m

Table 4.4.5. Design #2 Standard Cable Design Check.

Max Force (Ps)	818.35	kN
Safety Factor	3	
# of Cables (n)	5	
Pu	492	kN
FScalc	3.006046	
Span Length	77.96	m

In addition to considering the building material cost difference between design options #1 and #2, our team also deemed it necessary to consider the amount of excavation that would be required for each option. This factor is likely to impact the total project cost and schedule, and therefore, it is necessary to analyze the difference in required excavation totals when comparing both design options. Excavating 1 m³ of wet, medium textured soil to an average of 2nd lift, or 2.5 m, is estimated to require approximately 5 man-hours (The Project Estimate, 2019). Using the mean hourly wage of a construction laborer from the U.S. Bureau of Labor Statistics (2021), it will cost \$21.22 per hour of work per person. Therefore, excavating 1 m³ of the soil on site will cost around \$106. Below, in Table 4.4.6, is a comparison of the time and cost required for excavation of design option #1 and design option #2.

Table 4.4.6. Excavation Comparison between Design #1 and Design #2.

	Design Option #1	Design Option #2	Δ (Option #2 - Option #1)
Total Excavation (m ³)	73	115	42
Excavation Duration (man-hour)	364	572	209
Excavation Cost	\$7,719	\$12,144	\$4,425

The large difference in the required volume of excavation between the two design options indicates that design option #1 will require less time and money for excavation than option #2.

Based on the significant cost difference, considering both cost of material and excavation, and overall design efficiency in terms of material and schedule, the team has decided to move forward with design option #1.



4.5 Bridge Details

Based on the team's findings, a suspended bridge will meet the requirements to cross the Coilolo River across the proposed centerline. While standard designs were studied, a modified non-standard design will be required in order to reach the desired freeboard over the Coilolo River. A BO-3G-60B abutment design was chosen for the baseline abutment on the left side, and a BO-3G-60A abutment design was chosen as the abutment for the right. This design was chosen because it met the geometric requirements with the exception of the freeboard requirement, while minimizing cost and labor due to its shorter span. A summary of the achieved factors of safety are provided below in Table 9.

Table 4.5.1. Summary of Achieved Factors of Safety for Standard Design Checks.

Design Check	FS Required	Low Side Achieved	High Side Achieved
Cable Design	3.0	3.07	
Suspender Design	5.0	14.81	
Tower Overturning	1.5	5.95	5.82
Bearing Pressure	2.0	3.20	3.17
Anchor Sliding	1.5	2.75	3.34
Anchor Uplift	1.5	1.31	1.34

An analysis of the cables determined that four (4) 1-1/8" diameter cables would be sufficient to support the design load, with two handrail cables and two walkway cables. This number was chosen to ensure the factor of safety of 3 while minimizing steel costs. Calculations for the design loads and cable design are provided in Appendix C.1 and C.2 respectively.

Our walkway analysis revealed that standard, No. 3 sized imperial reinforcing bars are sufficient to serve as suspenders to meet the required factor of safety of 5.0. This analysis is reflected in Appendix C.3. Steel crossbeams will be required for the bridge span to accommodate the two walkway cables required. These will be constructed in accordance with the standard detail C1 (see Appendix D.8), which details a steel crossbeam and timber nailers. Likewise, the walkway for the bridge will be constructed in accordance with standard detail W3 (see Appendix D.7) for the decking on top of the crossbeams.

Bearing pressure and overturning moment analysis also met the required safety factors, and the calculations are shown in Appendix C.4.

Sliding analysis was completed on both abutments, and both met design requirements; the calculations are provided in Appendix C.5. For the left abutment, a soil angle of 5 degrees was assumed due to the fill necessary for the abutment. For the right abutment, an angle of zero degrees was assumed. Analysis on the anchor uplift forces showed that the current abutment designs did not meet the required factors of safety provided in the Bridge Binder Volume 2. Further analysis was completed to include the separate densities of the masonry and concrete in the overburden force resisting uplift, but the safety factor was still too low. In order to meet this requirement, a few different design changes could be made, including increasing the masonry back wall height to provide more volume for the overburden, increasing the density of the fill,

and increasing the volume of the anchor. Ultimately, design changes related to the position of the anchor and abutment sizes were made to meet this safety factor, as detailed in Section 5.

Separate calculations were made to determine the minimum design changes needed for each of these scenarios, and these are provided in Appendix C.5. On their own, these changes are somewhat extreme, so an optimal custom design will likely use a combination of these changes. Alternatively, the abutment designs could also be changed to BO-3G-80B on the left abutment, and BO-3G-80A on the right, which would both increase the back wall height and the anchor volume. All of these design options will be investigated in preparation for Review Call #2.

4.6 Concept Definition Call Follow-Up

Table 4.6.1. Action Items from Concept Definition Call.

Action Item	Responsible Party	Status
1 Implement new custom sag values	Design Manager	Complete
2 Update design drawings with required annotations	Project Manager	Complete
3 Continue to update the design to meet the required checks and become more efficient	Project Team	Complete

5.0 Design Process (Custom Design)

A narrative summary of the design process is provided herein. Please reference the full Rio Coilolo Suspended Bridge drawing set for details.

5.1 Design Standards and Objectives

Site approval and bridge type selection will conform to the following design criteria: Engineers in Action 2022 Bridge Binder Volume 2 and the Bridges to Prosperity Bridge Builder Manual, 5th Edition.

To guide the overall design, the team began with the objectives laid out by EIA in Section 2.1 of the Bridge Builder Manual Volume 2a, which are ordered by relative importance in the design process:

1. Safety

The design’s primary and most important objective is to ensure the safety of the bridge itself and its users. Beyond maintaining structural integrity, the design must also include features that promote the safe use of the bridge, such as guardrails along the abutment ramps to protect against fall risks.

2. Durability

The design’s second objective is to provide durability. This can be achieved in both the selection of durable materials and design features that work to extend the lifespan of the design.

3. Serviceability

Serviceability as a design objective focuses on how effectively the design functions, particularly from a user-centered design approach. In a suspended bridge design, this can manifest in reducing cable sway and deformations to make the pedestrian experience more comfortable.



4. Maintainability

This design objective focuses on creating a design that can be maintained by the community at manageable costs and rates for years to come.

5. Constructability

Constructability as a design objective entails ensuring that the design is feasible to construct in a safe and efficient manner.

6. Economy

This sixth design objective focuses on optimizing the economic efficiency of a design. This can be accomplished by making design choices that reduce expensive material, labor, or temporal costs.

7. Aesthetics

The final objective in design is aesthetics and focuses on creating a design that complements the natural environment and surroundings of the communities.

While all of these objectives guided our design, we mainly focused on optimizing the safety, serviceability, constructability, and economy of our standard design presented in Section 4. When developing the standard design, we identified a few areas of improvement related to these objectives and worked to achieve a design that better accomplished them in the non-standard design presented in Section 5 of this report. These areas of improvement are summarized below:

1. Safety:

Our standard geometric design did not meet the required uplift checks and freeboard requirements to provide a safe and structurally sound design. In the later design process, we focused on meeting these requirements and creating a safer design by adjusting the anchors and foundations of our abutments.

2. Constructability and Economy:

When considering the different design choices necessary to achieve the safety objective, we also needed to consider constructability and economy of these choices when picking the optimal design. For example, more simple design options that simply involved increasing the bridge span were discarded due to increased cable costs and the difficulty of excavation and backfill that they required. To prioritize constructability and economy, we decided against these designs in favor of options that required more non-standard design.

3. Serviceability:

One aspect of our standard design that needed to be substantially reevaluated was serviceability, particularly in terms of bridge accessibility. This guided our design choices related to the addition of features such as moving and extending the left abutment and adding ramps and guardrails to both abutments.



5.2 Left Side Anchor & Abutment Placement

The left abutment location and design was one of the major areas of consideration for our team moving forward from the standard geometric design. From the design presented in Section 4, the standard abutment and its setback of 3.00 m did not allow our design to conform to the geometric constraints, particularly the freeboard requirement and the ground profile slope angle. This design also had issues with achieving the required uplift factors of safety for the anchor.

Our final abutment placement, at 3.6 m back from the left edge of the bank, was governed mainly by the span and excavation limits of our project. Pushing the left abutment back into the hillside would have resolved the uplift issue described above but would have extended the span so much that we would require an extra cable, as well as more excavation. These considerations guided our final placement of the abutment; we aimed to maximize the bridge span on the left side (in order to minimize backfill behind the left abutment) to the extent that we could without requiring an additional walkway cable or significant benching excavation.

To both help with achieving the proper factor of safety for uplift and minimize backfill, we decided to modify the BO-3G-60B abutment by lengthening it by 1.4 m. This both increases the overburden on the anchor and pushes the anchor into the hillside. Originally the abutment was only increased away from the river bank, but moving the anchor too far back resulted in additional changes to the excavation plan that would affect the schedule and work needed. The abutment was therefore also increased in length towards the river to a small margin which also decreased the span resulting in the final setback from the bank of 3.6 meters. In addition to helping with uplift, lengthening the abutment and pushing the back wall closer to the hillside reduces the amount of fill necessary behind the back wall, subsequently improving bridge constructability.

In addition to these modifications to the abutment length and location, we also increased the foundation height to 1.5 m on the left side. This was done to help achieve the freeboard requirement and uplift safety factor.

With this modified abutment design, shown on page 3 in the Rio Coilolo Suspended Bridge drawing set, we will continue to use a standard A4 anchor on the left side.

5.3 Right Side Anchor & Abutment Placement

The right abutment was also modified from the standard design and is located 3.00 m back from the right edge of the bank. This placement minimized the bridge span while still achieving geometric conformance, especially in conjunction with the modified left abutment. Here, the standard A4 anchor was placed in a modified BO-3G-60A abutment which raised the anchor location by 0.5 meters to provide a more efficient design and address stability issues in the tower. The back wall height was also increased, and the angle of the ramp was adjusted, in order to provide sufficient overburden to combat anchor uplift forces. This final anchor placement resulted in an anchor elevation of 99.86 meters. This modified abutment design is shown on page 4 in the Rio Coilolo Suspended Bridge drawing set.

While this abutment location disrupts one of the makeshift roads on the right bank, the costs and labor required to increase the span past this road do not seem to be justified given that this is the only issue with the abutment in this location. The road is a makeshift dirt road which can be routed around the abutment, as the vegetation there will already have to be cleared.



5.4 Geometric Conformance

As mentioned in Section 5.1, compliance with design standards was the primary objective. Therefore, ensuring geometric conformance was crucial and was achieved, as itemized in Table 5.4.1. Note that the setback requirement was dictated by the assumption of soil conditions for both banks.

The required ground profile slope angle is 10 degrees for a standard design and 20 degrees for a non-standard design. The left side ground profile slope angle of our design is 23.12 degrees. The main concern with a higher ground profile slope angle is the increased soil behind the abutment resulting in an increased active earth pressure. Active earth pressure could cause the abutment to slide or the soil behind the abutment to cave in. The team performed sliding checks to test if the left abutment would slide under the active earth pressure; these checks passed, and the team confirmed that the increased left ground profile slope angle was not a concern. This can also be analyzed by the nature of the site and the hill to the left of the abutment. Since this site geometry is not present under the ramp of the abutment and the extreme amount of work that would need to be done to level this area, the team decided to work with the geometry present, as it did not affect the safety of any of the design checks.

Table 5.4.1. Geometric Conformance Summary.

Variable	Value	Units	Limit	Units	Check
Left Foundation Setback	3.6	m	3	m	OK
Right Foundation Setback	3	m	3	m	OK
Left Fdn Behind Angle of Friction	3.56	deg	35	deg	OK
Right Fdn Behind Angle of Friction	7.02	deg	35	deg	OK
Span	57.8	m	120	m	OK
Delta H	0.385	m	2.31	m	OK
Left Side Ground Profile Slope	23.12	deg	20	deg	Acceptable
Right Side Ground Profile Slope	0	deg	20	deg	OK
Left No. of Tiers	3	ea	3	ea	OK
Right No. of Tiers	3	ea	3	ea	OK
h_DL	2.31	m			
f	2.12	m			
Elevation of Low Side Walkway	104.271	m			
HWL	100.00	m			
Calculated Fb	2.15	m	2	m	OK

5.5 Comparison of Alternatives

Before deciding on the final design, other alternative designs were considered and compared based on cost, constructability, and design conformance. In order to make the approach ramp constructable and serviceable for community members, the team decided to place the end of the left abutment near the end of the hillside. This was done in order to allow for easy access to the ramp, which became difficult to accommodate for if the end of the ramp was placed too far from

the hillside. However, placing the ramp too far into the hill would necessitate a large amount of additional benching excavation and would likely extend the construction schedule.

Once an ideal placement for the end of the abutment was determined, the next issue was deciding how to adjust the abutment and span length to place it there. The team considered extending the span and using the appropriate standard abutment type for the left side. This could reduce uncertainty in design checks, as custom design checks would not be necessary. However, extending the span in this case would have increased the required number of cables from 4 to 5 cables due to the higher stresses. Since the steel cables are one of the most expensive materials used in the project, it was decided that the change in cost was too much to justify expanding the span by less than 10 meters. Instead, an extended abutment was considered with a modified (increased) angle for the ramp so that the end of the abutment was still at the appropriate location.

After making this adjustment, new issues in efficiency and stability were noticed, which required further changes. On both abutments, the eccentricity check of the tower failed, which could threaten the stability of the tower. In addition, the new design was inefficient in regards to anchor checks; the sliding safety factor was over double its requirement while the uplift safety factor passed by a much smaller margin. Due to these issues, the team decided to consider adjusting the anchor locations in both abutments in order to provide a better design.

For the right abutment, the anchor could be raised to decrease the anchor forces in the vertical direction, as well as decrease the eccentricity of the tower. The angle of the ramp wall was also adjusted in order to raise the back masonry wall and provide more overburden force on the anchor. This new design also reduced the amount of excavation and fill needed for the construction process, decreasing the overall cost and labor for the project.

For the left abutment, raising the anchor was also considered, but it could not be done as easily since the anchor was not as deeply embedded. Instead, lengthening the abutment was again considered. Increasing the length of the abutment away from the river bank to fulfill the eccentricity requirements could be done, but it would also require significantly more excavation, as benching would be required for a large portion of the adjacent hillside. Instead, increasing the abutment length to meet this requirement and then shifting the entire abutment towards the river bank was considered, as this would decrease the amount of excavation and time required by the workers. Since the foot of the abutment initially sat 4.14 meters from the edge of the bank, there was room for this modification. Additionally, this change would decrease the span of the bridge, which would then decrease the total dead load. Due to the low embankment of the anchor, a rock/grout bearing pad 20-30 cm under the anchor was also considered to add extra compaction under the anchor. While this change could be useful, it would also require benching excavation, and the schedule would once again be adversely affected; therefore, this option was not utilized as this would have added even more labor which was already being increased due to the extended abutment.

On the end of the leftward abutment, the access ramp connecting the ramp to the hillside was originally planned to slope in a downward arc to transition the two areas. This design would have used soil excavated from the hillside. This design choice, however, posed an issue in terms of drainage, as this soil could be washed away by rainwater. Instead a flat access ramp was proposed with a concrete cap and the same rock and grout fill as the abutment. This would provide a more compact transition area and prevent water from penetrating the ramp.



5.6 Design Checks

The table below summarizes the complete set of design checks for our non-standard bridge design. After completing our non-standard design, we first rechecked all of the Tier One design checks assessed for the standard design in Section 4 to make sure our design met those conditions before completing a more detailed analysis. The major Tier Two checks are summarized below and are detailed out in both Appendix C and the calculation spreadsheet in the Review Call folder.

Table 5.6.1. Safety Factor Checklist

Safety Factor Checklist			
Design Check	FS Required	Left Side Achieved	Right Side Achieved
Cable Design	3	3.07	
Suspender Design	5	14.81	
Tower Overturning	1.5	4.49	4.62
Bearing Pressure	2	4.49	4.62
Anchor Sliding	1.5	3.71	3.57
Anchor Uplift	1.5	1.54	1.53
Tower Overturning	1.5	1.64	1.65
Column moment capacity	$M_n > M/M_{cr}$	60.27	60.27
Tower Eccentricity	<0.45 m	0.4498	0.4476
Decking	See Sheet	Pass	Pass
Fencing	See Sheet	Pass	Pass
Construction Winch	1	3.28	3.57
Hoisting Uplift	1.5	7.69	21.78
Hoisting Sliding	1.5	1.73	4.75
Erection Hook	3	12.28	13.37
Concrete Flexure 1 Load factored Moment	< M_n	8.56	8.20
Concrete Flexure 1 Critical Moment	< M_n	35.78	35.78
Concrete Flexure 2 Load factored Moment	< M_n	8.56	8.20
Concrete Flexure 2 Critical Moment	< M_n	48.41	48.41
Calculated Dead Load	1.04	0.86	
Water Effect on Uplift	1.25	not required	1.47

**Note: See section below on tower eccentricity for more details about this design check*



Cable Analysis

Designs specified a cable with a diameter of 1-1/8". The breaking strength of such a cable was determined to be 492 kN from Table 3-3.1 of the Bridge Binder Manual Vol. 2 (see appendix C.2 Cable Analysis and Design). The team found that 2 handrail and 2 walkway cables would be sufficient to hold the determined tensile load of the bridge while minimizing the total number of cables that would need to be placed during construction. The calculations of the tensile forces present in the cables along with the further determination of the number of cables is shown in Appendix C.2.

Table 5.6.2 from the Bridge Binder Volume 2, as shown below, states that the 1-1/8" diameter cables will require 6 clamps per cable at the anchor. These cables will need to be placed 15 cm (6 inches) apart and require an applied torque of 225 ft-lb to be secure. This is detailed in the general notes on page 1 of the drawing set.

Table 5.6.2 Clamp Number, Spacing, and Torque Requirements.

Cable Diameter		Number of Clamps	Spacing		Torque ft-lb
(in.)	(mm)		(in.)	(cm)	
3/4	19	4	5	12	130
7/8	22	4	5	13	225
1	25	5	6	14	225
1-1/8	29	6	6	15	225
1-1/4	32	7	6	16	360
1-3/8	35	7	6	16	360
1-1/2	38	8	7	18	360

*Note that all clamps must be drop-forged.

Sag Values for hoisting, design, and live loading were provided by EIA for the project based on the bridge geometry. They are shown in table 5.6.3.

Table 5.6.3 Sag Values and Percentages.

Sag Values		
Hoisting	3.35%	1.94 meters
Design	4.00%	2.31 meters
Live	5.57%	3.22 meters

Uplift

Initial calculations for the Uplift Safety factor found the safety factor to be below the required value of 1.5. A non-standard design for the left abutment was chosen for the reasons described in section 5.5, and also decreased the uplift forces in the left abutment due to the decreased angle of the backstay cables. Further analysis of the uplift was made using a split cable analysis,

splitting the tension on the anchor into the handrail and walkway cables rather than idealizing it only in the handrail cables. These values are shown in Appendix C.2 and were used to re-evaluate the uplift safety factors along with a more detailed overburden analysis using the gravity forces from masonry and concrete areas contributing to overburden as seen in Appendix C.5. Since the volume of overburden had changed due to the non-standard design, it was necessary to do a Tier Two analysis on the anchor forces. These further analyses brought the factor of safety of uplift above the required 1.5 value.

The high water line present at the site posed an issue for the right side abutment as the anchor is partially under the elevation of the water line; therefore, an additional analysis of the buoyant water forces was done to ensure this did not affect the anchor forces. Based on site conditions at the area of the anchor placement and the distance from the river bank, a safety factor of 1.25 was used in this check. It was assumed that 100% of the water present around the concrete anchor would be displaced and that 60% of the fill would be displaced. This gave a safety factor of 1.47, meeting the desired requirements. This analysis can be viewed in Appendix C.8.

Sliding

While our non-standard design passed the Tier One checks for sliding, we completed the Tier Two checks for a more detailed and comprehensive analysis of the bridge. Using more detailed values for abutment component weights, as well as considering sidewall friction and soil forces, assured us that our abutments would not be at risk from sliding.

Tower Eccentricity

Design checks on the tower dictated that the eccentricity of the tensile forces should be analyzed, as it falls within the tower boundaries. Initial analysis of this feature showed that this test did not pass by about 2 cm on each side, meaning that the resultant force on the tower fell into the masonry section of the tower. This, along with other efficiency concerns, prompted new designs to be considered, as described in section 5.5. The final design altered the eccentricity in the tower, ensuring that the resultant force stayed within the boundaries of the concrete section of the tower. This analysis can be viewed in Appendix C.4.

Decking and Superstructure Checks

Checking the superstructure of the bridge involved checking the EIA standard details for timber decking (W3), steel crossbeams (C1), and fencing for the approach ramp (F3). These details are shown in Appendices D.7, D.8, and D.9. Both the decking and crossbeam analysis was straightforward, using the NDS and AISC codes, and both details passed. The fencing analysis was more complex due to the non-standard steel HSS sections used, as all the section properties needed to be calculated, but the fencing detail did pass all design requirements. These calculations are detailed fully in Appendix C.6.

Construction

The Tier 2 Construction checks were to determine the early strength of the concrete, the concrete flexure load factored moment, and the concrete flexure critical moment. These checks were conducted according to the strength of the concrete at day 3 and day 14. All Load Resistance and Factor Design (LRFD) requirements were met. Further checks include the construction sag calculations, winch analysis, and the erection hook analysis. All checks passed. It was determined that a 3.00% sag for construction could be used, that the loading effects

would not affect the uplift and sliding, and that the construction winches and erection hooks have the capacity to hold a cable loading under this sag. The properties of the construction winch and erection hook were taken from the details in Appendices D.5 and D.6.

Full calculations for these and further analyses are provided in Appendix C and the calculation spreadsheet in the Review Call 2 folder.

Load Assumptions

The following loads and load combinations were calculated in accordance with Bridge Binder Volume 2 as well as the Structural Design and Advanced Structural Design courses.

Permanent Load:

Dead Load (DL): 1.04 kN/m

The dead load design requirement is not to exceed 1.04 kN/m. Taking the dead load as a combination of the decking, crossbeam and nailer, suspenders, fencing, and cables, it is 0.864 kN/m, meeting the requirement.

Transient Load:

Live Load (LL): 4.07 kN/m

Reduced Live Load (LL): 3.55 kN/m

Primary Load Combination:

Distributed, Wc Primary (DL + LL): 4.49 kN/m

Secondary Load Combination:

Point Load: 2.22 kN

5.7 EIA Drawings Selection

EIA Standard Drawings:

- A4 anchor detail
- T4 tower detail
- W3 decking detail
- C1 crossbeam detail
- F3 fencing detail

Non-standard Drawings created by team:

- BO-3G-60B abutment detail for left abutment (modified)
- BO-3G-60A abutment detail for right abutment (modified)



6.0 Bill of Quantities

6.1 Quantity Take-Off

The estimated Bill of Quantities (BOQ) for all variable construction materials is shown in Table 6.1.1 below. The quantity estimate for these variable materials, as outlined in this table, is considered preliminary and is dependent upon the approval of the final bridge design. The BOQ estimate for these construction materials was completed in accordance with the EIA Bridge Program: Volume 2 Design Manual and the corresponding BP-301 Construction Management course on BEDU.

Table 6.1.1. Variable Construction Material BOQ.

Bill of Quantities Summary (Variable Material List)									
Description		Left Abutment	Left Tower	Walkway	Right Abutment	Right Tower	Total Needed	Contingency Factor	TOTAL
CABLE 1-1/8"									
Cable de 1-1/8"	m			386.00			386.00	1	386
CLAMP 1-1/8"									
Abrazadera Forjado de 1-1/8"	unit			48.00			48.00	1.05	51
TIMBER									
Madera Dura (200x20x5cm)	unit			144.39			144.39	1.08	156
TIMBER NAILER									
Madera Dura (100x20x5cm)	unit			58.75			58.75	1.08	64
CROSSBEAM									
Perfil U 4x5, 4 lb/ft	6m bar			14.69			14.69	1.04	16
SCREW (timber)									
Tirafondo 3/8" x 3 1/2"	box (118 ea)			7.34			7.34	1.25	10
SCREW (timber nailer)									
Tiradondo 3/8" x 2"	box (118 ea)			1.99			1.99	1.18	3
FENCING									
Malla O Galv. N 10 Alt 1.2 m	m^2			138.61			138.61	1.05	146
ROCK									
Piedra Bolón	m^3	146.43			132.15		278.58	1.05	293
TUBING									
Manguera de Succion de 3"	m	10.00			10.00		20.00	1.1	22
CEMENT									
Cemento Portland (50 kg bolsa)	50kg bag	204.45	7.56		207.99	7.56	427.57	1.13	484
SAND									
Arena	m^3	55.96	0.65		52.98	0.65	110.23	1.09	121
GRAVEL									
Grava Lavada	m^3	5.33	0.65		6.20	0.65	12.83	1.05	13.47
REBAR (#4)									
Acero Corrugado 1/2" (12mmx12m)	12m bar	2.50			2.50		5.00	1.05	5
REBAR (#5)*									
Acero Corrugado 5/8" (16mmx12m)	12m bar	0.50	2.00		0.00	2.00	4.50	1.05	5
REBAR (#6)									
Acero Corrugado 3/4" (20mmx12m)	12m bar	1.00			1.00		2.00	1.05	3
REBAR (#3)									
Acero Corrugado 3/8" (10mmx12m)	12m bar		1.39	19.83		1.39	22.61	1.05	23
PLASTIC HOSE									
Tubería de Alta Densidad de 2"	m		2.20			2.20	4.40	1.1	5
BRICK									
Ladrillo Gambote 18H 25x12x6cm	unit		545.00			545.00	1090.00	1.02	1112
WHEEL CABLE SADDLE									
Rueda de la Silla del Cable (Aro N 14)	unit		2.00			2.00	4.00	1	4
GALVANIZED METAL CLIPS (1.5cm x 5.5 cm)									
Clips de Metal Galvanizado (1.5cm x 5.5cm)	unit			346.52			346.52	1.1	382
GALVANIZED TUBE (1-1/2")									
Tubo Galvanizado de 1-1/2"	m			64.13			64.13	1.1	71
GALVANIZED TUBE (1-1/4")									
Tubo Galvanizado de 1-1/4"	m			24.93			24.93	1.1	28

*Note: Given that our team has not previously completed an EIA bridge project and therefore lacks necessary contingency factor data, the contingency factors applied in Table 6.1.1 are those provided by EIA for a typical bridge project, as defined in the EIA Bridge Program: Volume 2 Design Manual



In addition to the estimated Bill of Quantities (BOQ) for variable construction materials shown above, the BOQ estimate for static construction materials is shown in Table 6.1.2 below. The quantity estimate for these materials are considered final and are not dependent on the approval of the final bridge design. The BOQ estimate for these construction materials was derived from an evaluation of previous EIA bridge projects, the in-country manager estimate for the Coilolo River Pedestrian Bridge, the EIA Bridge Program: Volume 2 Design Manual, and the Example Bolivia Student BOQ.

Table 6.1.2. Static Construction Material BOQ.

Additional Material Estimates (Static Material List)									
Description		Left Abutment	Left Tower	Walkway	Right Abutment	Right Tower	Total Needed	Contingency Factor	TOTAL
TIE WIRE									
Alambre De Amarre	kg	2.5	2.5		2.5	2.5	10	-	10
GALVANIZED TIE WIRE									
Alambre Galvanizado	kg			5			5	-	5
BARBED WIRE CLAMPS									
Grampas para Alambre de Puas	kg			2			2	-	2
NAIL									
Clavo 2-1/2"	kg			2			2	-	2
POLYURETHANE WATERPROOFING (5L)									
Impermeabilizante de poliuretano	unit	0.5			0.5		1	-	1
ROOFING TAR (ASPHALT PAINT)									
Pintura Asfáltica de 3.5 LTS Color Negro	Galon			2			2	-	2
RED ANTICORROSIVE PAINT									
Pintura Anticorrosiva de 3.5 LTS color rojo	Galon			2			2	-	2
YELLOW ANTICORROSIVE PAINT									
Pintura Anticorrosiva de 3.5 LTS color amarillo	Galon			2			2	-	2
GREEN ANTICORROSIVE PAINT									
Pintura Anticorrosiva de 3.5 LTS color verde	Galon			2			2	-	2
RED SPRAY PAINT									
Spray Rojo	unit	3			3		6	-	6
GASOLINE									
Gasolina	L			100			100	-	100
WOOD CONSTRUCTION MARKERS									
Marcadores de construcción para madera	unit			10			10	-	10
BRUSHES 4"									
Brochas 4"	unit			3			3	-	3
BRUSHES 3"									
Brochas 3"	unit			3			3	-	3
STEEL SANDPAPER									
Lija Para Acero	m			6			6	-	6
5 GALLON BUCKET									
Balde 5 gal	unit	7			7		14	-	14
PLASTIC WATER TANK (50 gal)									
Tanque plástico de Agua (50 gal)	unit	1			1		2	-	2
FINE MESH FOR STRAINING SAND									
Malla para colar arena (fina 1/8")	m	2			2		4	-	4
POLYESTER ROPE (20m)									
Cuerda Poliester (20m)	unit	2			2		4	-	4
WHEELBARROWS									
Carretillas	unit	2			2		4	-	4
WOODEN BOARDS 1" x 12" x 14"									
Tablas de Madera 1" x 12" x 14"	unit	6			6		12	-	12
PICKAXES									
Piochas	unit			4			4	-	4
FACE SHEILDS/VISORS									
Palas	unit			4			4	-	4
GLOVES									
Guantes	unit			40			40	-	40
Gafas									
Safety Glasses	unit			40			40	-	40
PLASTIC									
Plástico Negro	m			30			30	-	30



A direct comparison between the Variable Construction Material BOQ (shown in Table 6.1.1 above) and the in-country manager estimate for the Coilolo River Pedestrian Bridge (shown in Appendix B.1) is shown in Table 6.1.3 below.

Table 6.1.3. Material BOQ Discrepancy Report.

Calculated Material Estimates (Variable Material List)					
Description		UVA Team Estimate	In Country Manager Estimate	Difference (UVA - In Country)	Percentage Difference
CABLE 1-1/8"		386	392.26	-6	-1.6%
Cable de 1-1/8"	m				
CLAMP 1-1/8"		51	52	-1	-1.9%
Abrazadera Forjado de 1-1/8"	unit				
TIMBER		156	160	-4	-2.5%
Madera Dura (200x20x5cm)	unit				
TIMBER NAILER		64	65	-1	-1.5%
Madera Dura (100x20x5cm)	unit				
CROSSBEAM		16	16	0	0.0%
Perfil U 4x5, 4 lb/ft	6m bar				
SCREW (timber)		10	9	1	11.1%
Tirafondo 3/8" x 3 1/2"	box (118 ea)				
SCREW (timber nailer)		3	3	0	0.0%
Tiradondo 3/8" x 2"	box (118 ea)				
FENCING		146	156	-10	-6.4%
Malla O Galv. N 10 Alt 1.2 m	m^2				
ROCK		293	345	-52	-15.1%
Piedra Bolón	m^3				
TUBING		22	28	-6	-21.4%
Manguera de Succion de 3"	m				
CEMENT		484	455	29	6.4%
Cemento Portland (50 kg bolsa)	50kg bag				
SAND		121	140	-19	-13.6%
Arena	m^3				
GRAVEL		13	15	-2	-10.2%
Grava Lavada	m^3				
REBAR (#4)		5	7	-2	-28.6%
Acero Corrugado 1/2" (12mmx12m)	12m bar				
REBAR (#5)*		5	4	1	25.0%
Acero Corrugado 5/8" (16mmx12m)	12m bar				
REBAR (#6)		3	5	-2	-40.0%
Acero Corrugado 3/4" (20mmx12m)	12m bar				
REBAR (#3)		23	25	-2	-8.0%
Acero Corrugado 3/8" (10mmx12m)	12m bar				
PLASTIC HOSE		5	4.4	1	13.6%
Tubería de Alta Densidad de 2"	m				
BRICK		1112	960	152	15.8%
Ladrillo Gambote 18H 25x12x6cm	unit				
WHEEL CABLE SADDLE		4	NOT LISTED	-	-
Rueda de la Silla del Cable (Aro N 14)	unit				
GALVANIZED METAL CLIPS (1.5cm x 5.5 cm)		382	NOT LISTED	-	-
Clips de Metal Galvanizado (1.5cm x 5.5cm)	unit				
GALVANIZED TUBE (1-1/2")		71	DIFFERENT UNITS - LIKELY SIMILAR	-	-
Tubo Galvanizado de 1-1/2"	m				
GALVANIZED TUBE (1-1/4")		28	DIFFERENT UNITS - LIKELY SIMILAR	-	-
Tubo Galvanizado de 1-1/4"	m				

Major discrepancies between these two material estimates for the Coilolo River Pedestrian Bridge are shown below:

1) *Required Quantities of Rock:*

- a) The total required quantities of rock to be collected was determined by the UVA team to be 52 m³ (15.1%) less than that originally proposed by the in-country manager. This discrepancy can likely be explained by the UVA team's decision to utilize 1.5m tall foundations only on the bridge's left abutment, as opposed to



custom foundations on both abutments, resulting in an overall decrease in the total abutment volume (both in the foundation and approach ramp volumes).

2) *Required Quantities of Cement, Sand, and Gravel:*

- a) The total required quantities of cement, sand, and gravel was determined by the UVA team to be 29 bags (6.4%) greater than, 19 m³ (13.6%) less than, and 2 m³ (10.2%) less than the original estimate, respectively. Given that the estimated amount of required cement increased between the two estimates and that the estimated amount of required sand and gravel decreased, it is likely that either different volume ratios or contingency factors for concrete and slurry mix designs were used by the UVA team and the in-country manager. However, the UVA team is confident in their estimate for these construction materials, as we utilized the Bolivia-specific volume ratios provided by EIA in the BP-301 Construction Management course to determine component material quantities.

3) *Required Quantities of Rebar:*

- a) The total required quantities of #4, #5, and #6 rebar was determined by the UVA team to be 2 bars (28.6%) less than, 1 bar (25%) greater than, and 2 bars (40%) less than the original in-country manager estimate, respectively. This discrepancy can likely be explained by the difference in the standard anchor details used between the two designs, as the UVA team utilized standard detail A-4 (two walkway cables and a 20-60m span) while the in-country manager likely utilized standard detail A-5 (two walkway cables and a 60-100m span), resulting in slightly different rebar quantity requirements.
- b) In addition, the total required quantity of #3 rebar was determined by the UVA team to be 2 bars (8%) less than the original in-country manager estimate. This discrepancy can likely be explained by the difference in span lengths for the bridge design, as the in-country manager design calls for a span of 61m, while the updated final design calls for a span of 57.8 m.

4) *Required Quantities of Brick:*

- a) The total required quantities of brick was determined by the UVA team to be 152 ea (15.8%) greater than the in-country manager estimate. Although the UVA team is unaware of the reason for this discrepancy between the two estimates, the UVA team is confident in their estimate for brick masonry, as they utilized the guidelines set out in the BP-301 Construction Management course to determine the required material quantities for each tower.

6.2 Equipment and Tools

The suspended bridge construction process can be broken down into 10 steps as described in Volume 3: Field Operations of the Bridge Binder, provided by Engineers in Action: Construction Layout; Excavation; Foundation and Tiers; Towers; Anchor and Cable Preparation; Approach Ramp Stage I; Cable Hoisting; Approach Ramp Stage II; Construct Walkway, Grout Tubes and Construct Ramp Topping Slab; and Approach Ramp Stage III and Completion. Equipment and tools required for each step of this process are laid out in Table 6.2.1 below with the exception of Approach Ramp Stage III and Completion, which does not require any equipment to be used. Additionally, key equipment and tools needed every week will be listed on the full construction schedule provided in Appendix E.2.



Table 6.2.1. Equipment and Tool Requirements for Bridge Construction.

Construction Layout	<ul style="list-style-type: none"> ● 100 Meter Measuring Tape ● String Line ● Spray Paint ● Machete 	<ul style="list-style-type: none"> ● Level ● Plumb Bob ● Stakes ● Hammer ● Automatic level
Excavation	<ul style="list-style-type: none"> ● Measuring Tape ● String Line ● Plumb Bob ● Excavation Bars ● Shovels ● Hammer ● Buckets ● Water tube 	<ul style="list-style-type: none"> ● Level ● Automatic Level ● Survey Rod ● Spray Paint ● Picks ● Machete ● Carpentry Nails
Foundation and Tiers	<ul style="list-style-type: none"> ● Shovels ● Masonry Tools ● Level ● String Line ● Spray Paint ● Tamping Rod 	<ul style="list-style-type: none"> ● Buckets ● Construction Square ● Plumb Bob ● Tape Measure ● Stakes
Towers	<ul style="list-style-type: none"> ● Shovels ● Grinder ● Construction Square ● Plumb Bob ● Tape Measure ● Wire Cutters ● Saw Blades ● Angle Grinder ● Generator 	<ul style="list-style-type: none"> ● Buckets ● Masonry Tools ● Level ● String Line ● Spray Paint ● Saw ● Hacksaw ● Angle Grinder Discs
Anchor and Cable Preparation	<ul style="list-style-type: none"> ● Shovels ● Buckets ● Angle Grinder ● Construction Square ● Plumb Bob ● Tamping Rod ● Spray Paint ● Mallet 	<ul style="list-style-type: none"> ● Pickaxes ● Buckets ● Masonry Tools ● Level ● String Line ● Tape Measure ● Wire Cutters ● Cement Mixer
Approach Ramp Stage I	<ul style="list-style-type: none"> ● Shovels ● Masonry Tools ● Level ● String Line ● Tape Measure ● Hammer ● Scaffolding 	<ul style="list-style-type: none"> ● Pickaxe ● Buckets ● Construction Square ● Plumb Bob ● Tamping Rod ● Cement Mixer



Cable Hoisting	<ul style="list-style-type: none"> ● Winch ● Automatic Level and Tripod ● Sockets ● Measuring Tape ● Spray Paint ● Duct Tape 	<ul style="list-style-type: none"> ● Torque Wrench (small, medium and large) ● 4-foot Level ● String Line ● Permanent Marker ● Walkie Talkies
Approach Ramp Stage II	<ul style="list-style-type: none"> ● Shovels ● Construction Square ● Plumb Bob ● Tamping Rod ● Cement Mixer 	<ul style="list-style-type: none"> ● Buckets ● Level ● String Line ● Tape Measure
Construct Walkway, Grout Tubes and Construct Ramp Topping Slab	<ul style="list-style-type: none"> ● Masonry Tools ● Shovels ● Hack Saw ● Drill Press ● Impact Driver ● Drill Charger and Batteries ● Socket Wrench ● Measuring Tape ● Markers ● Cement Mixer 	<ul style="list-style-type: none"> ● Buckets ● Wood Saw ● Blades ● Drill ● Drill Bits ● Sockets ● Hammers ● Pipes for Bending ● Suspenders ● Wire Cutters

7.0 Construction Plan

Construction on site will be conducted according to the drawing set, as described above and as shown in Appendix D. Physical copies of this drawing set and any other documentation necessary for the successful construction of the Coilolo River Pedestrian Bridge will be available on site. The QC manager will hold responsibility for checking and documenting the as-built structure dimensions. In the sections that follow, a detailed description of the team’s construction plan is provided; these descriptions, in conjunction with the supporting appendices, will guide the project team in the implementation of the bridge design at the Coilolo site.

7.1 Excavation Drawings

Appendix E.1 contains the sample excavation drawings for both the left and right abutments. Excavation for each of the abutments is broken up into two phases: Phase I and Phase II. Phase I shows the excavation required to install the foundation, while Phase II shows the excavation required to install the ramp walls and anchor. For the left abutment, Phase I will involve excavating dirt to a depth of 1 m in the same footprint as the foundation. For the right abutment, excavation will involve digging a hole to the exact dimensions of the foundation. Benching is not required for either of the foundation excavations because excavation into the ground will not exceed 1.5 m. Because the ramp walls and anchor of the left abutment will not exceed 1.5 m below the surface, there is no benching required for this abutment. There are two access excavation shapes in the left abutment excavation drawing. The leftmost shape signifies excavation necessary to make the transition from the hillside to the left abutment smoother.



The rightmost access excavation shape is a 30 cm hole that will allow the access ramp to be anchored into the ground.

The right abutment, specifically the ramp wall and anchor, will be installed at a depth of greater than 1.5 m and, as a result, benching will need to be implemented during the excavation of this abutment. By creating a bench 1 m offset from the main excavation of Phase II, the risk of injury due to fall or soil cave-in is greatly reduced. Like the left abutment, the right abutment requires access excavation because the approach ramp will need to be extended to meet the grade of the existing surface. As such, a 30 cm deep access excavation is required to allow for this extension to be lodged into the ground.

7.2 Construction Schedule

A complete work breakdown structure (WBS) and detailed construction schedule for the Coilolo River Pedestrian Bridge are provided in Appendices E.3 and E.2, respectively. Table 7.2.1 below summarizes the detailed schedule and depicts all major construction activities and their corresponding durations. The assumption was made that site preparation and foundation excavation will commence on May 15 and will be completed by May 21, prior to the team's arrival. In addition, initial material collection was assumed to have been performed prior to the team's arrival and will continue throughout the duration of the project as needed. Note that excavations are expected to be completed by the community per the excavation drawings, included in Appendix E.1.

Table 7.2.1. Construction Schedule Summary.

Date	Activity
May 15 - May 21	Site Preparation, Mark Excavations, and Foundation Excavations
May 22 - June 4	Foundation and Tier Construction
June 5 - June 11	Tower Construction and Abutment/Ramp Wall Excavations
June 12 - June 18	Anchor and Approach Walls
June 19 - June 25	Cable Hoisting, Sag Set, and Begin Approach Fill
June 26 - July 2	Superstructure: Decking and Fencing
July 3 - July 7	Complete Approach Fill and Finishing
July 8	Bridge Inauguration

Following the arrival of the team, and prior to the commencement of foundation and tier construction, the Quality Control Manager is to ensure that all site preparation and excavation work has been completed in accordance with the QC sign offs for these activities, shown in Section 7.3. Proper site preparation and layout is critical to the successful construction of the Coilolo River Pedestrian Bridge; therefore, special attention should be paid to confirming the layout and dimensions of the bridge centerline, layout, and excavations.

Construction activity durations, relationships, and procedures were approximated through an analysis of several previous EIA bridge projects, and modifications were made to consider the unique characteristics of the Coilolo River Pedestrian Bridge. For example, excavation durations were approximated through the analysis of three previous EIA bridge projects, and the corresponding excavation rates were approximated and applied to the Coilolo bridge site (see Appendix E.4). A similar analysis was performed to approximate the durations of several other construction activities unique to the Coilolo River Pedestrian Bridge, including the construction of the 1.5m tall custom foundations and the 57.8 m span bridge deck. In terms of the construction procedures unique to the Coilolo bridge site, our team has determined that the cables can be walked across the Coilolo River during hand hoisting due to the flat nature of the site and the small depth of the HWL (approx. 0.5m) in relation to the river bed.

In addition to the construction activities listed on the critical path schedule shown in Appendix E.2, our team has identified several additional “float activities” that can be completed throughout the duration of the project (time permitting). However, these activities must be completed by certain dates, specified in Table 7.2.2 below, in order to avoid critical path delay.

Table 7.2.2. Float Activities.

Float Activities			
Task	First Start Date	Required Completion Date (EOD)	Number of Available Work Days
Prepare Tower Materials: Cut & Bend Rebar	May 22	June 5	13
Prepare Tower Materials: Attach Stirrups / Prepare Cage	May 22	June 5	13
Prepare Anchor Materials: Cut & Bend Rebar	May 22	June 13	20
Prepare Anchor Materials: Attach Stirrups / Prepare Cage	May 22	June 13	20
Decking Preparation: Cut, Drill, and Paint Crossbeams	May 22	June 25	30
Decking Preparation: Cut, Drill, and Attach Nailers	May 22	June 25	30
Decking Preparation: Cut & Bend Suspender Rebar	May 22	June 25	30
Decking Preparation: Sort & Drill Deck Boards	May 22	June 27	32
Decking Preparation: Paint Fences	May 22	June 29	34

The following description provides a explanation of the construction procedures and considerations necessary to complete each task listed in the detailed project schedule. This description is split into three sections: Site Preparation, Construction Phase 1, and Construction Phase 2.

Site Preparation

Site preparation involves completing the initial work that must be done prior to performing construction activities. It is pertinent that the site preparation activities are completed prior to bridge construction, as they will likely increase construction efficiency, productivity, and safety throughout the duration of the project.



Construction Phase 1

1. *Materials*

- a. Material Collection (2-6 weeks): Material collection involves collecting all materials necessary for construction that are not purchased and delivered to the jobsite. Given that the Coilolo bridge site is in Bolivia, it is likely that sand (in addition to materials such as cement, rebar, cables, etc.) will be sourced locally and delivered to the site via trucks.

2. *Foundations and Tiers*

- a. Site Layout and Preparation (1-2 days): The layout for bridge excavation and construction is one of the most crucial stages of all activities listed on the detailed project schedule. Site layout and preparation involves transferring critical design information from the drawings to the topography of the site. It is assumed that site layout and preparation will be completed prior to the arrival of the student team on-site.
- b. Foundation Excavations (1 week): Special considerations must be made for excavations that exceed 1.5 meters in depth, as benching/sloping is required for such a scenario. As mentioned, it is also assumed that foundation excavation will be completed prior to team arrival on-site. See Appendix E.1 for excavation drawings.
- c. Foundation/Tier Construction (2 weeks): For the Coilolo bridge site, foundation construction is expected to take longer than that for a traditional bridge, as the left abutment foundation is 33% larger than that typically constructed. Given that each abutment will require 3 tiers on each side, the utilization of scaffolding (fall protection) will be necessary for tier 3 and tower construction.

3. *Towers*

- a. Tower Construction (1 week): The construction of the abutment towers occurs in four steps, as defined in the EIA Bridge Program Volume 3: Field Operations Manual. Throughout this stage of construction, anchor, ramp wall, and cable area excavation should be completed in accordance with the excavation drawings.

Construction Phase 2

1. *Anchors & Approach Walls*

- a. Anchors (2 days): Prior to this stage of construction, the anchor reinforcing cage should have been assembled by the team. During this stage, the reinforcing cage should be placed in the anchor pit, and tubing should be wrapped around the cage.
- b. Construct Ramp Wall Foundation (2 days): During anchor placement and pouring, the construction of the ramp wall foundations should begin. It is critical that ramp wall foundations are constructed prior to cable hoisting to transfer cable load from the anchor to the tiers.
- c. Construct Approach Walls (3 days): While the anchors are curing prior to cable hoisting, the remainder of the approach walls should be constructed.

2. *Cable Hoisting and Sag Setting*

- a. Hand Hoisting and Hoisting Preparation (1 day): Following the curing of the anchor and the completion of the ramp wall foundation, cables should be hand-hoisted.



	<ul style="list-style-type: none"> ● Ensure that no ground water is entering excavation ● Check soil bearing capacity at base of excavation (if possible) ● Record all as-built dimensions and elevations
Foundations and Tiers	<ul style="list-style-type: none"> ● Ensure the excavation is free of standing/seeping water ● Confirm orientation with respect to centerline ● Ensure proper use of plan and elevation dimensions (including masonry wall thickness) ● Ensure interiors are filled with rock and grout (no soil) ● Ensure mortar and grout are placed within one hour of mixing ● Record all as-built elevations and dimensions
Towers	<ul style="list-style-type: none"> ● Confirm orientation with respect to centerline ● Confirm reinforcing bar size and placement ● Confirm sizing of concrete column ● Ensure saddle elevations are level with one another ● Ensure saddle alignment with bridge centerline ● Record all as-built elevations and dimensions
Anchors	<ul style="list-style-type: none"> ● Ensure the excavation is free of standing/seeping water ● Confirm orientation with respect to centerline ● Confirm reinforcing bar size, quantity, bends, and placement ● Ensure proper tubing and erection hook placement ● Record all as-built elevations and dimensions
Ramp Walls	<ul style="list-style-type: none"> ● Ensure the excavation is free of standing/seeping water ● Confirm masonry wall thickness ● Confirm top of wall elevations ● Ensure connection to both anchor and foundation/tiers ● Ensure mortar is used within one hour of mixing ● Record all as-built elevations and dimensions
Cable Hoisting	<ul style="list-style-type: none"> ● Ensure anchor has properly cured ● Verify span length and difference in elevation ● Inspect cable for wire damage/splices ● Ensure cable and clamp sizing ● Ensure handrail cables are in proper bearing position on tower saddles ● Ensure walkway cables are threaded through sleeve and between rebar guides on walkway hump ● Confirm calculated f-value ● Confirm number, spacing, and torquing of clamps



	<ul style="list-style-type: none">• Ensure cable tubing filled with grout and cables are coated in tar• Record all as-built dimensions
Back Wall and Ramps	<ul style="list-style-type: none">• Ensure the interior is filled with rock and grout (no soil)• Ensure tamping of fill material to minimize voids• Confirm concrete topping slab thickness• Ensure concrete and grout placed within one hour of mixing• Record all as-built dimensions
Walkway	<ul style="list-style-type: none">• Verify cables are level and at correct sag• Confirm cross beams dimensions and spacing• Ensure nailers and decking boards are dimensioned correctly and are properly fastened• Confirm proper vertical distance between handrail and walkway cables• Confirm suspenders are wrapped tightly around crossbeam and handrail cable• Confirm fencing is sufficiently attached to deck and handrail cables
Completion	<ul style="list-style-type: none">• Ensure bridge decking is free of debris• Clear work area• Ensure access to bridge is graded correctly• Mark handrail cables at centerline saddle

As noted in the table above, the QC manager must verify and record the as-built dimensions of the project at the various stages of construction directly on the design drawings. The as-built dimensions will be paired with a QC photo inventory to show the proper execution of the construction plan.

It will be key for the EIA and student team to stay vigilant during the construction process so that all QC issues can be addressed as soon as possible. The early identification and correction of QC errors are pertinent to minimize the need for costly bridge modifications or potential bridge component demolition and reconstruction. If procedural errors are discovered early in the process, correctional measures can be implemented to ensure that workers proceed with the correct techniques. If dimensional errors are identified during any stage of the construction process, corrective action must be taken immediately to avoid compounding effects. It is the responsibility of the QC manager and technical advisor to ensure that all physical dimensions are within a previously agreed-upon construction tolerance, or extent of variation from design specifications.

7.4 Challenging Design and Constructability Elements

The UVA team has identified the following critical design and constructability challenges that the Coilolo site presents:

Transportation of Materials and Tools: The team expects the materials provided by the community to be onsite prior to the team arrival. This material will be staged on both sides of the river to allow for greater ease of access during construction. Tools must be stored in a safe place overnight to ensure they are not damaged or stolen.

Increased Abutment Heights: The total height of all tiers for the left and right abutments will be 4.5m and 4.0m above existing grade, respectively. Per OSHA, in construction, any drop over 6 ft (1.8 m) requires fall protection. Due to the use of 3 tiers for both abutments, work on the upper tiers presents an increased fall hazard, requiring the need for scaffolding while constructing the third tier and tower for both abutments. It is important that all workers onsite understand the risks and how to prevent harm in their native language. The team, particularly the safety manager, will work with the local community to ensure understanding of this fall hazard.

Weather Challenges: Daytime temperatures in Coilolo, between May and September, are typically in the 70s, with nighttime temperatures in the 30s. Because of the wide range in daily temperatures, especially with colder temperatures at night, the team will need to take steps related to cold curing concrete. This includes pouring the concrete early in the day to take full advantage of the warmer temperatures before nightfall. Additionally, tarps can be positioned over the concrete to trap heat from escaping in order to maintain a higher temperature throughout the night.

Excavation: The Coilolo River bridge site is unique in that it is more characteristic of a flood plain than a gorge. During excavation, the team may experience difficulties related to high water tables and groundwater. In order to mitigate this issue, the team may need to use pumps during excavation to remove excess water from the area of excavation.

Drainage: Due to the steep slope on the left bank, the team will need to take caution when excavating and backfilling the hillside behind the left abutment. Care must be taken to ensure a smooth transition from existing grade to the back of the proposed abutment, and an effort must be made to minimize the likelihood of pooling water in this area. In order to avoid drainage issues, the team has reduced the difference between grades with a smooth transition. It is important that this condition is viewed in the field and any adjustments are made if water pools and is unable to drain.

Design and Construction Call Follow-Up

Table 7.4.1 – Action Items from Review Call 2

Action Item	Responsible Party	Status
1 General report revisions	Project Team	Complete
2 Adjust left abutment to improve efficiency and add concrete/masonry approach ramp	Design/Construction Managers	Complete
3 Adjust right abutment to improve efficiency (raise anchor)	Design Manager	Complete
4 Adjust BOQ to reflect #3 rebar unbending method	Construction Manager	Complete
5 Minor drawing set edits	Project Manager	Complete



Appendix A: Site Information

A.1 Maps

Community: COILOLO
District: ZUDÁÑEZ

Region: CHUQUISACA
Country: BOLIVIA

GPS Coordinates:
N/S $-19^{\circ}10'00.7''$
W/E $64^{\circ}40'12.5''$

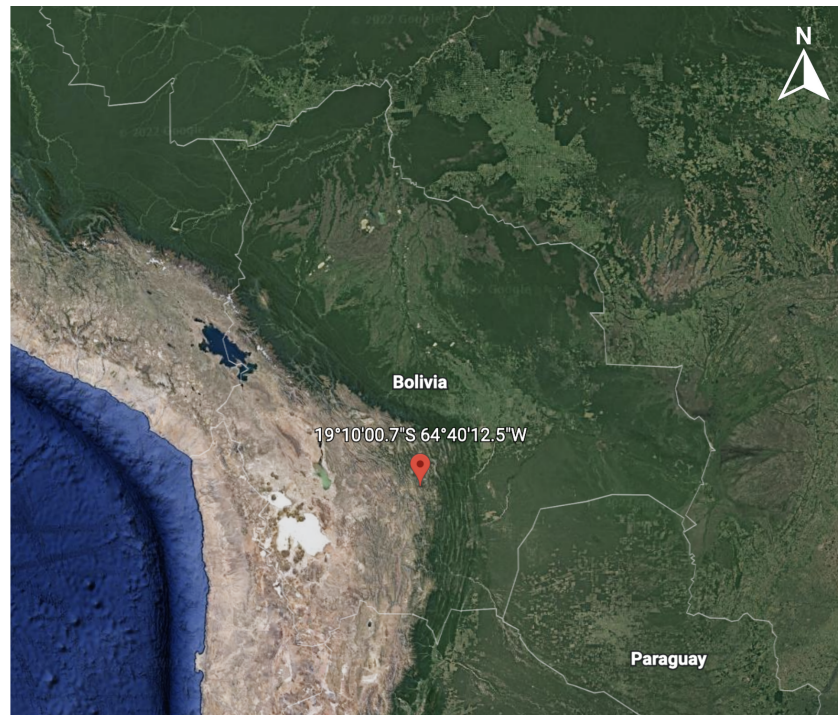
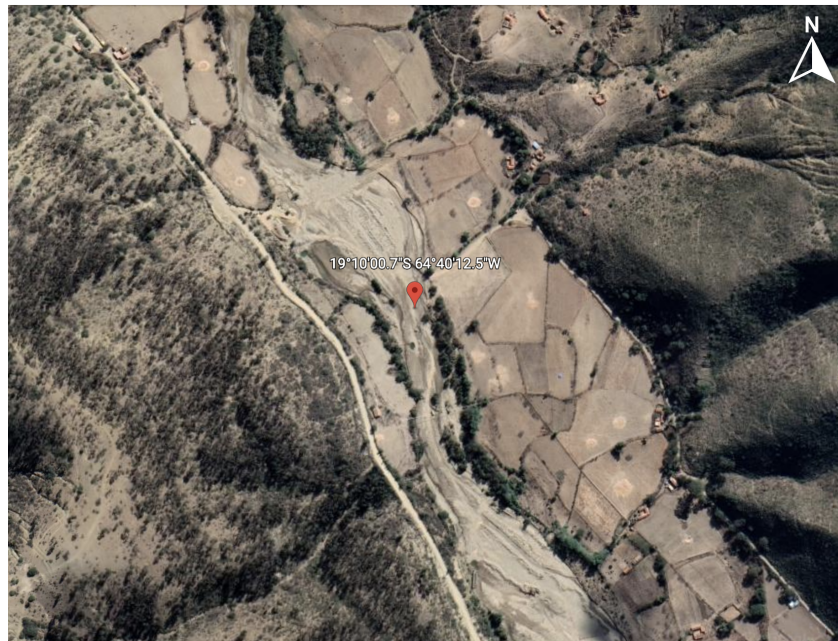



A.2 Media

A.2a Downstream





A.2b Upstream





A.2c Left Bank, Towards River





A.2d Left Bank, Away





A.2e Right Bank, Towards River





A.2f Right Bank, Away





A.3 Autocad Survey Profile





A.4 Project Assessment



Project Social Assessment

Advisor: Richar Galvez. Date: 8 de marzo de 2022.

[Full Name]

1. Location Information

Proposed Bridge Name: Puente Peatonal Río Coilolo. (Coilolo River Pedestrian Bridge)

[Must be a unique name for this crossing, not just the name of the river or community]

Name of the community or communities that are direct beneficiaries: Coilolo y Tipa Tipa.

Name of the municipality: Zudañez

Name of the department: Chuquisaca.

Name of the river: Río Coilolo.

Latitude: -19.166861° Longitude: -64.670142°

2. Information about the site

When is the site accessible in a light vehicle with 4x4 drive?

Never All year round Sometimes: _____

Name of the nearest paved or cobblestone road: Carretera Sucre - Monteagudo.

Name of the nearest town: Zudañez.

Travel time from the site to the nearest town: 15 Minutes by Light Vehicle

Quality of service cell: Non-existent In some places Good

Cell service companies: Entel

Describe the accesses for the transfer of materials to the right and left sides of the river:

Left: There is access to this place

Right: There is access to this place



What local materials exist in the river, in the community, or in nearby communities?

Stone Sand Fine wood Formwork Gravel Other: _____

Are there any trees, structures or property that would be affected by the construction of the bridge?

The bridge would affect part of the soccer field.

General site information and accessibility: _____

The houses are far from the site, there is little vegetation in the place, the climate is temperate, the road is passable dirt for Nissan Condor trucks and light vehicles.

3. Social Information

Number of direct beneficiaries of the bridge: **740 inhabitants.**
[People for whom access is consistently blocked]

Number of boys and girls who would benefit directly: **10**

Number of women of reproductive age (15 – 49) who would be beneficiaries: **0**

Population of all direct and indirect beneficiary communities: **800 inhabitants.**
[Total population of all communities that would potentially use the bridge, including those directly served]

Primary economic activities and high schools: **Agriculture and Breeding of Animals**

Main crops: **Potato, corn, wheat, peas, broad beans, barley, carrot, onion, oregano and peach.**

Animal husbandry: **Cows and Sheep**

What are the months of planting, harvesting and other activities in the field of agriculture or other temporary jobs where people spend all their time, which would make it impossible for them to fully participate in the construction of the bridge?

January February March April May June July August September October November December

Notes on the population: **The families in this population are dedicated to agriculture and the raising of domestic animals; the families live in different sectors of the community, their houses are built of adobe with thatch and corrugated iron roofs, in the community there is a school only up to 5th grade.**

How often and where do the community(ies) meet? *[Weekly, monthly, specific date]*

People meet every 20th of the month at their union headquarters.



4. Community Map

Include features such as location of community or major population centers, location of proposed bridge, major roads and paths, schools, health centers, markets, churches, bus stops, and community buildings or houses.

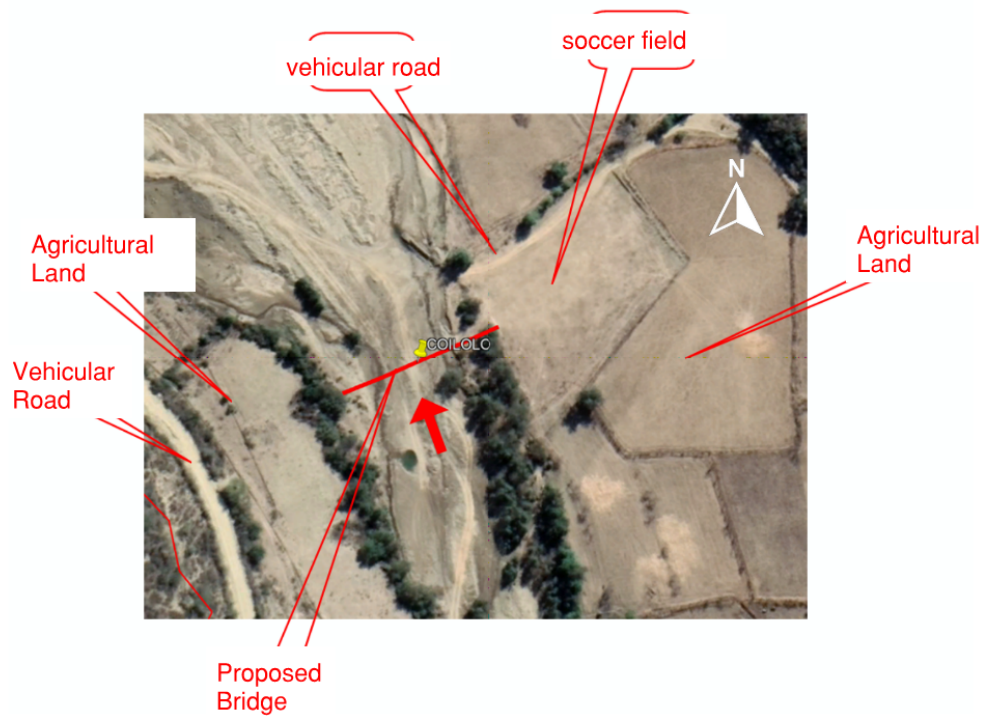



6. River Information

Description of important services, opportunities, or destinations that the river isolates:

U. E. Salvador Miranda (Coilolo), U. E. Federico Coli (Zudañez), U. E. Ignacio Prudencio Bustillo (Zudañez), U. E. Mixed Jaime Zudañez (Zudañez), Zudañez Health Center, Transportation, Sports, Social Events and Agriculture.

[This may include primary or secondary schools, clinics or hospitals, farms or markets, government services, churches or any other destination important to the community Be as detailed as possible and include the types of schools or health centers and how many people they serve, the size of markets and how often they occur, and other details that will help contextualize and particularize the needs of the community and, among them, that of a bridge]

Number of people injured when crossing the river in the last three years: _____ .

Number of people people who died crossing the river in the last three years: _____

Description of the accident or death of people when crossing the river, with dates:

[Include the number of accidents involving injuries or deaths. For example, if there was a major flood and three people were injured during this one event trying to cross, clear that up. It should be clear how many injuries or fatalities were single events]

Flood time during the rainy season: 1 day _____ *[When the river floods, how long does it last?]*

Current crossing method: By foot (walking) _____
[Swim, wooden bridge, etc. .]

Nearest crossing point: By different places of the river. _____

Information about property or land on both sides of the proposed bridge site

[Who owns the land, and whether they have expressed interest in supporting or concern about a bridge]:

Left side: Green Area _____

Right side: Soccer Field _____

Planned local and regional transportation infrastructure projects *[Include description and any known locations or dates]:*



6. Isolation

Number of days per year that the river is difficult or impossible to cross: **180 Days.**

Distance from the proposed bridge site to the nearest population center [km]: 7

Distance from the center of the beneficiary community to the proposed bridge site [km]: 1

Distance from the proposed bridge site to the main market [km]: 7

Distance from the bridge site to the nearest health center [km]: 7

Distance from the proposed bridge site to the high school [km]: 7

Travel time from the proposed bridge site to the main market [On foot, in minutes]:

120 min

7. Contacts, municipality and community

1. Name: Lucio Sandoval. Position:

Dirigente de Coilolo. (Leader of Coilolo.) Tel.:

73401334

CI: _____

E-mail: _____

2. Name and surname: Jaime Sandoval.

Position:

Autoridad de Agropecuaria y Riego (Agricultural and Irrigation Authority.) Tel.:

73442315

CI: _____

E-mail: _____

3. Name and surname: Eulogio Vargas.

Position: Strio. de Relaciones de Coilolo.

Tel.: 67639152 CI: _____



E-mail: _____



4. Name: _____

Position: _____

Phone: _____ CI: _____

E-mail: _____

5. Name: _____ Position: _____

_____ Phone: _____

_____ CI: _____

E-mail: _____

8. Bolivia addendum

Does the Municipality have a PTDI (Territorial Comprehensive Development Plan), a census or some other backup with data information from each community?

The municipality has the PTDI.

9. Rotary addendum

What other types of projects are needed?

School/Classroom(s) Health Post Restroom(s) Irrigation Potable Water Other:

Does the community/municipality already have final designs for some of these projects? If so, which ones?



10. Notes



A.5 Technical Survey Form



TECHNICAL EVALUATION

Name of the project: Const. Coilolo River Pedestrian Bridge.
 Location: Municipality of Zudañez. Assessor: Richar Galvez
 GPS: Latitude: -19.166861° and Longitude: -64.670142°. Date: March 8th, 2022

PROFILE DRAWING

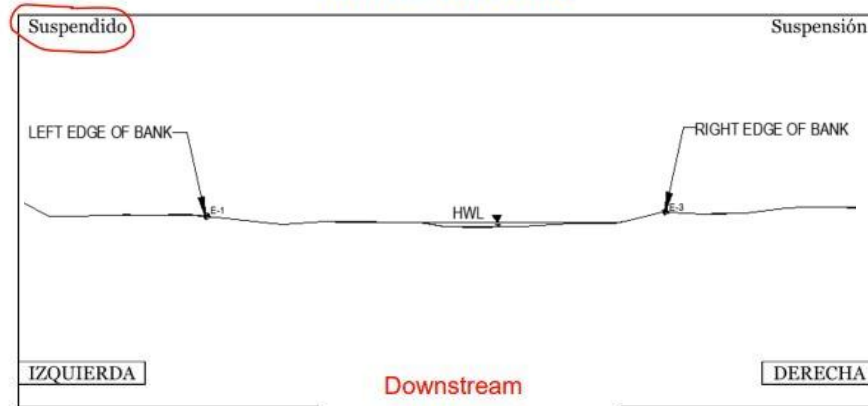

BM1	Height of inst.			
BM2	Height of inst.		Reference point	
BM3	Height of inst.		Reference point	
BM4	Height of inst.		Reference point	

POINT	REF.	DESCRIPTION *	ADEL (+) BACK (-)	LOW	MEDIUM	HIGH	NOTES or ANGLE
PE		POINT STATION					
PR		REFERENCE POINT					
E-1		STAKE 1					
E-2		STAKE 2					
E-3		STAKE 3					
PA-1		ARCH POST 1					
PA-2		ARCH POST 2					
HWL1							
HWL2							



SITE DESCRIPTION

• **LEFT SIDE:**

On this side the land is flat longitudinally and transversally, there is a temporary road, there is little vegetation.

• **RIGHT SIDE:**

On this side the land is flat longitudinally and transversally, there is a provisional road, there is a soccer field, there are two molle trees that must be cut before starting construction.

• **Obstructions (rocks, roads, canals, pipes, power lines, trees, drainage, erosion, crops, etc.):**

• **Access condition:**

Access reaches both sides of the river.

SOIL CLASSIFICATION

	Coarse-Grained	Fine-Grained	Rock
Left Side	<input checked="" type="checkbox"/> Gravel soil	<input type="checkbox"/> Silty Soil	<input type="checkbox"/> Bedrock (fractured: Y/N)
	<input checked="" type="checkbox"/> Sandy	<input type="checkbox"/> Clayey soil	<input type="checkbox"/> Soft rock (fractured: Y/N)
Right Side	<input type="checkbox"/> Gravel	<input type="checkbox"/> Silty Soil	<input type="checkbox"/> Bedrock (fractured: Y /N)
	<input checked="" type="checkbox"/> Sandy	<input checked="" type="checkbox"/> Clayey soil	<input type="checkbox"/> Soft rock (fractured: Y/N)

PHOTOS AND VIDEOS

<input checked="" type="checkbox"/> Left survey limit	<input checked="" type="checkbox"/> Left ravine top
<input checked="" type="checkbox"/> Right survey limit	<input checked="" type="checkbox"/> Right ravine top
<input type="checkbox"/> Riverbed	<input type="checkbox"/> Maximum water level
<input type="checkbox"/> Soil, left side	<input type="checkbox"/> Soil, right side
<input type="checkbox"/> Current crossing location	<input checked="" type="checkbox"/> Marked points
<input type="checkbox"/> Site access	<input checked="" type="checkbox"/> Site description
<input type="checkbox"/> Community	<input type="checkbox"/> Crew location



NOTES

TECHNICAL SURVEY CHECKLIST

- Walk 200 meters upstream and downstream from the site proposed or from the crossing point
- Measure 2 or 3 lines in the first visit
- Estimation of the length of the bridge: 20 m to 120 m
- Estimation of the “freeboard” (floodplain 2 m, gorge 3 m) with descent = 5%. Height difference between the lowest side and the maximum water level must be greater than $L/20$.
- Estimation of the height difference. Maximum 4% of length, ± 2 meters with levels
- Space 25 meters from ravines on both sides, width 5 meters
- Site access for both sides, especially during construction season?
- Ask about land ownership! Make sure the owners agree!
- Ask at least two people for the HWL! Measure 2 points, one on each side if possible. (Highest anticipated water level)
- Avoid utilities! Power lines, canals, light poles, roads, pipelines, etc.
- Avoid confluences and curves (hydrological consideration)
- Signs of erosion? Benches and surroundings
- Soil classification, dig 1 meter if suspicious
- Draw line on aerial view if necessary
- Suggest FFL and FFR on profile drawing
- Side slopes, steep?
- Do not forget about the height of the instrument!
- Don't forget about the HWL (2 points if possible) and the bottom of the river (right and left)!
- Leave stakes on the line, 4 if possible, or rocks with color
- Ask people in the community to remember and keep the points marked with stakes/rocks
- Someone or something for proportion/perspective in photos and videos + comments
- The following figure shows where to take photos and videos

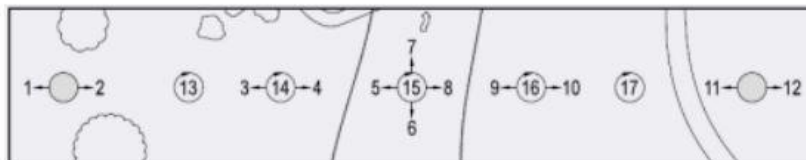



Appendix B: Draft Agreement for the Coilolo River Pedestrian Bridge

B.1 In Country Manager Material List

LISTA DE MATERIALES, SERVICIOS Y MONTOS TOTALES DE FINANCIAMIENTO DEL PROYECTO:

CONSTRUCCIÓN PUENTE PEATONAL RÍO COILOLO

MATERIALES:

Nº	DESCRIPCIÓN	UNIDAD DE MEDIDA	CANTIDAD CALCULADA	P. UNITARIO EN BS.	P. PARCIAL EN BS.
FUNDACIÓN INGENIEROS EN ACCIÓN					145,338.40
1	CABLE DE ACERO GALVANIZADO DE 1-1/8"	ML	392.26	330.00	129,445.80
2	ABRAZADERA FORJADA DE 1-1/8"	PZA	52.00	180.00	9,360.00
3	TUBO GALVANIZADO DE 1-1/2"	BARRA	14.00	170.00	2,380.00
4	TUBO GALVANIZADO DE 1-1/4"	BARRA	9.00	154.00	1,386.00
5	ELECTRODO E-6013	KG	9.00	25.00	225.00
6	ARO Nº 15	PZA	4.00	130.00	520.00
7	MANGUERA DE SUCCIÓN DE 3"	ML	28.00	70.00	1,960.00
8	POLITUBO DE 2"	ML	4.40	14.00	61.60
GOBIERNO AUTÓNOMO MUNICIPAL DE ZUDANEZ					98,281.00
1	CEMENTO PORTLAND	BOLSA	455.00	52.00	23,660.00
2	PERFIL UPN DE 4"x5.4 LB/FT Y L=6 M	BARRA	16.00	555.00	8,880.00
3	ACERO CORRUGADO DE 3/8" (10MM)	BARRA	25.00	58.00	1,450.00
4	ACERO CORRUGADO DE 1/2" (12MM)	BARRA	7.00	89.00	623.00
5	ACERO CORRUGADO DE 5/8" (16MM)	BARRA	4.00	155.00	620.00
6	ACERO CORRUGADO DE 3/4" (20MM)	BARRA	5.00	256.00	1,280.00
7	ALAMBRE DE AMARRE	KG	6.00	13.00	78.00
8	ALAMBRE GALVANIZADO Nº 14	KG	3.00	18.00	54.00
9	CLAVO 2-1/2"	KG	2.00	13.00	26.00
10	TIRAFONDO GALVANIZADO CABEZA HEXAGONAL DE 3/8"x2" Y GRADO 2	PZA	275.00	1.10	302.50
11	TIRAFONDO GALVANIZADO CABEZA HEXAGONAL DE 3/8"x3-1/2" Y GRADO 2	PZA	965.00	1.30	1,254.50
12	GRAPA PARA ALAMBRE DE PÚA	KG	2.00	16.00	32.00
13	MALLA OLÍMPICA GALV. Nº 10, ROMBOS DE 3-1/2"x3-1/2" Y H=1.20 M	M²	156.00	37.00	5,772.00
14	LIJA PARA ACERO	ML	6.00	9.00	54.00
15	ARENA COMÚN	M³	125.00	170.00	21,250.00
16	ARENA LAVADA	M³	15.00	270.00	4,050.00
17	GRAVA LAVADA	M³	15.00	270.00	4,050.00
18	LADRILLO GAMBOTE 18H DE 25x12x6 CM	PZA	960.00	1.10	1,056.00
19	MADERA DURA DE 100x20x5 CM	PZA	65.00	65.00	4,225.00
20	MADERA DURA DE 200x20x5 CM	PZA	160.00	113.00	18,080.00
21	PINTURA ANTICORROSIVA DE 3.5 LTS COLOR ROJO	GALÓN	2.00	125.00	250.00
22	PINTURA ANTICORROSIVA DE 3.5 LTS COLOR AMARILLO	GALÓN	2.00	125.00	250.00
23	PINTURA ANTICORROSIVA DE 3.5 LTS COLOR VERDE	GALÓN	2.00	125.00	250.00
24	PINTURA ASFÁLTICA DE 3.5 LTS COLOR NEGRO	GALÓN	2.00	180.00	360.00
25	GASOLINA	LTS	100.00	3.74	374.00
COMUNIDAD DE COILOLO					17,250.00
1	PIEDRA	M³	345.00	50.00	17,250.00



Appendix C: Design Calculations

C.1 Loads Calculations

Tier 1

Dead Load Distributed		
w	1.0	kN/m ²
tributary width	1.04	m
w_DL	1.04	kN/m

Distributed Live Load (metric)		
w(unreduced LL)=	4.07	kN/m ²
Bridge Area, A=	60.06	m ²
*reduced LL since A>37 m ²		
w(reduced LL)=	3.55	kN/m
*reduced LL greater than 3.14 kN/m ²		

Load Combinations		
Wtotal (reduced)	4.59	kN/m
Wtotal (nonreduced)	5.27	kN/m

Tier 2

GEOMETRY		
SPAN	57.8	YES
WIDTH	1.04	m
AREA	60.06	m ²
DEAD LOAD		
AREA DEAD LOAD	1	kN/m ²



LINE DEAD LOAD	1.04	kN/m
LIVE LOAD		
UNREDUCED LINE LIVE LOAD	4.07	kN/m
REDUCED LINE LIVE LOAD	3.55	kN/m
reduction factor	3.42	kN/m
reduction factor'	3.42	kN/m
UNREDUCED POINT LIVE LOAD	2.22	kN
TOTAL LOADS		
REDUCED LIVE TOTAL LOAD	4.59	kN/m
UNREDUCED LINE TOTAL LOAD	5.27	kN/m
Ph		
	Value	Units
Decking		
Deck Material	Timber	
Deck Density	900	kg/m ³
Deck Thickness	5	cm
Deck Width	1.04	m
W_Deck	0.46	kN/m
Crossbeam and Nailer		
Crossbeam Material	Steel	
Crossbeam Density	7850	kg/m ³
Crossbeam Cross Sectional Area	10	cm ²
Crossbeam Length	150	cm
Nailer Material	Timber	
Nailer Density	900	kg/m ³
Nailer Width	20	cm
Nailer Length	100	cm
Nailer Height	5	cm
Crossbeam Spacing, s	1	m
W_Cross	0.21	kN/m
Suspenders		
Suspender No.	3.00	
Suspender Cross Sectional Area	71.00	mm ²
Suspender Length	2.00	m



Suspender Steel Density	7850.00	kg/m ³
W_Suspender	0.02	kN/m
Fencing		
Fencing Density	4.06	kg/m
Fencing Height	1.20	m
W_Fence	0.04	kN/m
Cables		
Number of Cables	4.00	
Cable Diameter	1.125	
Cable Weight	3.49	kg/m
W_Cables	0.14	kN/m
Total Dead Load		
W_DeadLoad	0.864	kN/m
Design Dead Load	1.04	kN/m
OK?	YES	



C.2 Cable Analysis and Design

Table 3.3-1: Cable Properties (Hanes Supply Manual for galvanized 6x19 IWRC – 7x7 wire core rope)

Diameter		Area		Weight		Tensile Strength*	
in	mm	in ²	mm ²	lb/ft	kg/m	kip	kN
3/8	9.53	0.068	44.0	0.260	0.39	12.8	57.1
7/16	11.1	0.093	59.9	0.350	0.52	17.3	77.1
1/2	12.7	0.121	78.2	0.460	0.68	22.6	101
9/16	14.3	0.153	99.0	0.590	0.88	28.6	127
5/8	15.9	0.189	122	0.720	1.07	35.0	156
3/4	19.1	0.273	176	1.04	1.55	50.0	222
7/8	22.2	0.371	240	1.42	2.11	67.7	301
1	25.4	0.485	313	1.85	2.75	87.9	391
1-1/8	28.6	0.614	396	2.34	3.48	111	492
1-1/4	31.8	0.758	489	2.89	4.30	136	604
1-3/8	34.9	0.917	592	3.50	5.21	173	768
1-1/2	38.1	1.09	704	4.16	6.19	194	862

*Tabulated tensile strength is reduced to 85% from reported manual values because cable is used (not new), galvanized, and due to end condition (sheave size ratio).

Tier 1

Cable Analysis			
Ph	584.76	m	
Cable Sag	3.22	m	
dH	0.113	m	
Span Length	57.8	m	
value	Low Side (Left)	High Side (right)	units
angle to horizontal	12.58	12.80	degrees
Vertical Mainstay Pv	130.53	132.84	kN
Total Mainstay Pt	599.15	599.66	kN
Backstay angle	23.83	24.31	degrees
Pt back	639.25	641.65	kN
Pv back	258.27	264.15	kN
Tower reaction R	388.81	396.99	kN



Cable Analysis			
Ps Max	641.65	kN	
Factor of safety needed	3.0		
Cable diameter	Tensile Capacity	n exact	n decision
1-1/8"	492	3.91	4
Factor of Safety Achieved	3.07		

Tier 2

Unsplit Value			
Ph	589.100	kN	
Force Max (cable design)	641.121	kN	
	Left Side (High)	Right Side (Low)	Units
theta(hand)	0.23	0.22	rad
theta(hand)	13.04	12.32	degrees
Pt	604.70	602.99	kN
Pv	136.46	128.68	kN
Alpha (hand)	0.41	0.39	rad
Alpha (hand)	23.24	22.22	degrees
Pt,back	641.12	636.36	kN
Pv,back	252.98	240.65	kN
Rtower	389.44	369.33	kN
Split Cable Handrail			
	Left Side (High)	Right Side (Low)	Units
Pt_main_h	302.35	301.50	kN
Pv_main_h	68.23	64.34	kN



Ph_main_h	294.55	294.55	kN
mu hand	0.20	0.20	
Pt_back_h	264.26	265.12	kN
Pv_back_h	104.27	100.26	kN
Ph_back_h	242.82	245.43	kN
Pv_hand (1 column)	86.25	82.30	kN
Ph_hand (1 column)	25.87	24.56	kN
Split Cable Walkway			
	Left Side (High)	Right Side (Low)	Units
alpha (walkway)	0.321	0.307	rad
alpha (walkway)	18.42	17.57	degrees
Pt_main_w	302.35	301.50	kN
Pv_main_w	68.23	64.34	kN
Ph_main_w	294.55	294.55	kN
mu walk	0.23	0.23	
Pt_back_w	264.04	264.96	kN
Pv_back_w	83.43	79.98	kN
Ph_back_w	250.51	252.59	kN
Pv_back total	187.70	180.24	kN
Pv_walk total	151.66	144.32	kN
Ph_walk_total	44.04	41.96	kN



C.3 Walkway Analysis

Tier 1

Suspender Analysis		
n handrail	2	
n walkway	2	
n total	4	
Area cable	71	mm ²
P beam	5.27	kN/m
fy	275	Mpa
Psus	1.32	kN/m ²
Factor of Safety req	5.0	
actual factor of safety	14.81	

C.4 Tower and Foundation Analysis

Tier 1

Overturning Moment			
Value	Left side	Right Side	Unit
back angle alpha	23.83	24.31	degrees
Pback	560.01	559.81	kN
PvBack	226.26	230.45	kN
PhSaddle	72.49	74.59	kN
PvSaddle	356.79	363.30	kN
PhHand	36.24	37.29	kN
PhWalk	36.24	37.29	kN
Yhand	5.5	5.5	m
Ywalk	4.4	4.4	m
M_Overturning	358.81	369.21	kN-m



Restorative Moment			
Value	Left side	Right Side	Unit
P_foundation	249.08	249.08	kN
P_tier 1	193.52	193.52	kN
P_tier 2	142.81	142.81	kN
P_tier 3	96.93	96.93	kN
P_tower	30	30	kN
X_foundation	1.8	1.8	m
X_tier1	1.875	1.875	m
X_tier2	1.95	1.95	m
X_tier3	2.03	2.03	m
X_tower	2.1	2.1	m
X_saddle	2.2	2.2	m
M_Restorative	2133.88	2148.21	kN-m

Overturning Safety Check		
Value	Left side	Right Side
Required FS	1.5	1.5
Factor of Safety	5.95	5.82

Bearing Pressure			
Value	Left side	Right Side	Unit
q_u	286	286	kN-m
Mo	358.82	369.21	kN-m
Mr	2133.88	2148.21	kN



Ptotal	1069.12	1075.635	kN
B*	3.32	3.31	m
l	3.6	3.6	m
qs	89.44	90.33	kN-m
FS required	2		2
Factor of Safety	3.20		3.17

Tier 2

Over turning analysis			
	Left tower (high)	Right Tower (Low)	
Pv_hand_single	86.25	82.30	kN
Ph_hand_single	25.87	24.56	kN
Pv_walk	151.66	144.32	kN
Ph_hand	44.04	41.96	kN
Ptower	30	30	kN
Moverturning	95.21	90.46	kN-m
Mrestore	156.37	149.52	kN-m
FSrequired	1.5	1.5	
FS	1.64	1.65	
Flexural Capacity			
Factored loads			
PvLL	70.34	67.56	kN
PhLL	21.41	20.54	kN
MLL	20.80	19.95	kN-m
PvDL	20.65	19.84	kN
PhDL	6.29	6.03	kN
MDL	6.11	5.86	kN-m
M	40.61	38.94	kN-m



Tower Capacity			
As	0.0004	0.0004	m ²
fy	275	275	MPa
fc	10	10	MPa
b	0.4	0.4	m
a	0.0324	0.0324	m
d	0.625	0.625	m
Mn	66.97	66.97	kN-m
Cracking Moment			
S	0.0327	0.0327	m ³
Fr	242.75	242.75	psi
Fr	1.67	1.67	MPa
Mcr	54.69	54.69	kN-m
Check			
Factored M	54.02	51.79	kN-m
Factored Mcr	58.63	58.63	kN-m
Factored Mn	60.27	60.27	kN-m
Final check	OK	OK	
Tower Eccentricity			
Resultant	0.291	0.290	radian s
Resultant	16.69	16.62	degree s
E _{max}	0.45	0.45	m
E _{calc}	0.4498	0.4476	m
pass?	OK	OK	



C.5 Anchor Analysis

Tier 1

Anchor Sliding			
Value	Left side	Right Side	Unit
Panchor	67.03	67.03	kN
Mu_saddle	0.15	0.15	
Beta Soil	5	0	degrees
phi	30	30	degrees
H1	2.5	2.5	m
Pv Anchor	218.74	218.74	222.67
PhAnchor	495.26	492.93	kN
Ka	0.3385	0.333	
P active	55.98	55.13	kN
Rs	640.73	639.88	kN

Resisting force			
Value	Left side	Right Side	Unit
Ramp Wall	804.06	1082.92	kN
Ramp Fill	1087.04	1130.27	kN
Soil Area	134.4	441.24	kN
Concrete Cap	113.25	136.00	kN
Pt Main	599.15	599.66	kN
Rn	1760.08	2137.62	kN



Sliding Safety Check		
Value	Left side	Right Side
Required FS	1.5	1.5
Factor of Safety	2.75	3.34

Uplift			
Value	Left side	Right Side	Unit
Pvback/Vs	226.26	308.84	kN
Aanchor	0.95	0.95	m ²
Pvanchor	67.03	67.03	kN
Volume fill	12.31	12.99	m ³
Vn	296.20	230.46	kN
Fs required	1.5	1.5	
Factor of Safety	1.31	1.34	

Tier 2

Sliding			
Value	High Side	Low Side	Units
Sidewall Friction Forces			
Effective Internal Angle of Friction, Φ'	0.52	0.52	radians
Coeff. of Lateral Earth Pressure, K_0	0.5	0.5	
Soil Unit Weight	17.66	17.66	kN/m ³
Soil depth above front of foundation, D_{front}	0.7	0.7	m
Soil depth above back of anchor, D_{back}	2.7	1.83	m



Embedment below soil surface, H	1.7	1.265	m
Height of embedment wall, B	0.85	0.6325	m
Embedment wall length, t	13.7	15.2	m
Angle of friction between soil & surface	0.262	0.262	radians
Force of sidewall friction, F _s	93.67	57.54	kN
Ph tower			
Ph main	589.10	589.10	kN
Ph back walk	250.51	252.59	kN
Ph back hand	242.82	245.43	kN
Ph tower	95.77	91.07	kN
Additional Ramp Walls			
40 cm thick wall area	5.597	5.597	m ²
60 cm thick wall area	16.002	16.002	m ²
70 cm thick wall area	46.003	53.560	m ²
Backwall Cross-Sectional Area	0.428	0.354	m ²
Masonry Density	2100.000		kg/m ³
Precise Ramp Wall Masonry Weight, F _{ramp,masonry}	932.780	1037.118	kN
Undisturbed Soil Sliding Resistance/Updated Ramp Self-Weight			
Ramp Wall Area, A _{ramp}	32.47	37.85	m ²
Ramp Fill Area, A _{fill}	29.15	28.81	m ²
Undistrubed Soil Area, A _{soil}	3.33	9.04	m ²
Fill/Soil Width, w _{fill}	2.2	2.2	m
Fill Material Density	18.62	18.62	kN/m ³
Soil Density	17.66	17.66	kN/m ³
Undistruebd Soil Weight, W _{soil}	129.25	351.14	kN
Ramp Fill Weight, W _{ramp}	1193.98	1180.25	kN



Sliding Forces			
Precise Ramp Self-Weight	2126.94	2217.56	kN
Horizontal Sliding Force, R_s	617.66	642.49	kN
Horizontal Sliding Resistance, R_n	2292.45	2291.18	kN
Factor of Safety Achieved	3.71	3.57	
Greater than or Equal to 1.5?	Yes	Yes	

Sliding Check (metric)			
Value	High Side	Low Side	Units
Factor of Safety, FS		1.5	-
Internal Angle of Friction, Φ	0.524	0.524	radians
Soil Angle above Ground, β	0.404	0.000	radians
Soil density, γ		1800	kg/m ³
Sliding friction coefficient, μ	0.577	0.577	-
width of anchor beam, w		3.0	m
Soil Height, H	1.5	1.6	m
Ratio of Lateral to Vertical Pressure, K_a	0.456	0.333	
Active Lateral Earth Pressure, P_{active}	27.20	22.60	kN
Horizontal Force on the Anchor, $P_{h,anchor}$	986.65	996.05	kN
Tower Vertical Force, $P_{v,tower}$	648.33	617.85	kN
Tower Self-weight, P_{tower}		30	kN
Sum of the Tiers + Foundation Self Weights, P_{tiers}	806.85	682.23	kN



Anchor Self-weight, Panchor	67.0322		kN
Ramp Self-weight, Pramp	1720.49	2234.40	kN
Sliding Force coefficient	0.577		
Horizontal Sliding Force, Rs	1013.86	1018.65	kN
Horizontal resisting Force, Rn	1889.49	2168.60	kN
Factor of Safety Achieved	1.86	2.13	
Greater than or equal to 1.5?	Yes	Yes	

Uplift			
Value	High Side	Low Side	Units
Factor of Safety, FS	1.5		
Anchor Area, A_anchor	0.95		m ²
Concrete Density	2400		kg/m ³
Anchor beam width, w	3		m
Anchor Self-Weight, P_anchor	67.03	67.03	kN
Uplift Force, Pv back	187.70	180.24	kN
Overburden Fill Density	1900		kg/m ³
Anchor beam depth, b	1.1		m
Back wall height, H	3		m
Overburden top length, B	2.832		m
Volume of Fill, V_fill	6.896	6.447	m ³
Volume of Masonry, V_masonry	3.638	3.407	m ³
Volume of Cap Concrete, V_concrete	0.812	0.811	m ³
Density of Masonry Walls	2100		kg/m ³
Overburden Self-Weight, P_Overburden	222.37	209.23	kN



Vertical Uplift Force, V_s	187.70	180.24	kN
Vertical Resisting Force, V_n	289.40	276.27	kN
Factor of Safety Achieved	1.54	1.53	
Greater than or Equal to 1.5?	Yes	Yes	



C.6 Superstructure

Tier 2

SUSPENDER ANALYSIS			
GEOMETRY AND PROPERTIES			
CABLES			
HANDRAIL CABLES		2	
WALKWAY CABLES		2	
TOTAL CABLES		4	
REINFORCING			
DESIGNATION		No. 3	
SUSPENDER AREA		71	mm
REINFORCING YIELD STRESS		275	MPa
		275000	kN/m ²
LOADS + CHECKS			
TOTAL DISTRIBUTED BEAM LOAD		5.27	kN/m
AXIAL LOAD, P _{suspender}		1.32	kN
FoS REQUIRED		5	
FoS ACTUAL		14.81	GOOD

DECKING ANALYSIS			
SECTION/DETAIL	W3		
LOADS + GEOMETRY			
UNREDUCED AREA LOAD	4.07	kN/m ²	
UNREDUCED DISTRIBUTED LINE LOAD	0.81	kN/m	
UNREDUCED POINT LOAD	2.22	kN	
DECK WIDTH (b)	20	cm	
THICKNESS (d)	5	cm	
DECKING AREA (b*d)	100	cm ²	
MOMENT OF INERTIA	208.33	cm ⁴	
SECTION MODULUS	83.33	cm ³	



LOAD FACTORS		POINT LOAD	DIST. LOAD
BENDING + SHEAR	LOAD DURATION FACTOR	1.6	1
		SHEAR	BENDING
	WET USE FACTOR	0.97	0.85
	TEMPERATURE FACTOR	1	
	INCISING FACTOR	1	
BENDING ONLY	BEAM STABILITY FACTOR	1	
		DECKING	CROSS BEAMS
	SIZE FACTOR	1.2	1.5
	FLAT USE FACTOR	1.15	1.1
	REPETITIVE MEMBER FACTOR	1.15	1
CAPACITY VALUES FOR TIMBER DECKING			
	POINT LOAD	DIST. LOAD	
SHEAR STRESS (F _v)	1.44	1.44	MPa
BENDING STRESS (F _b)	3.96	3.96	MPa
SHEAR STRESS (F' _v)	2.23	1.40	MPa
BENDING STRESS (F' _b)	8.55	5.34	MPa

DECKING FORCES		POINT LOAD	DIST. LOAD	
FIRST BOARD	LENGTH	0.9		m
	BENDING MOMENT	0.500	0.082	kN-m
	SHEAR	1.11	0.37	kN
MIDDLE BOARDS	LENGTH	1.0		m
	BENDING MOMENT	0.45	0.10	kN-m
	SHEAR	1.32	0.51	kN
WHOLE BRIDGE	MAX. BENDING MOMENT	0.500	0.102	kN-m
	MAX. SHEAR	1.32	0.51	kN
	BENDING STRESS, F_b	5.99	1.22	MPa
	SHEAR STRESS, F_v	0.198	0.076	MPa



TIMBER DECKING CHECK		POINT LOAD	DIST.LOAD
CHECK BENDING MOMENT			
	FoS	1.43	4.37
CHECK SHEAR			
	FoS	11.30	18.30

CROSSBEAM ANALYSIS			
SECTION/DETAIL	C1		
GEOMETRY			
TIMBER			
CROSSBEAM SPACING		1	m
NAILER WIDTH		20	cm
NAILER THICKNESS		5	cm
DECK THICKNESS		5	cm
BRIDGE DECK WIDTH		1.04	m
TIMBER DENSITY		900	kg/m ³
STEEL			
SECTION	C4x5.4		
YIELD STRENGTH		240	MPa
ELASTIC SECTION MODULUS, S _y		4.54	cm ³
PLASTIC SECTION MODULUS, Z _y		9.26	cm ³
LOADING			
UNREDUCED AREA LOAD		4.07	kN/m ²
DIST. DECK LOAD		0.44	kN/m
DIST. NAILER LOAD		0.09	kN/m
TOTAL UNREDUCED LINE LOAD		4.76	kN/m
POINT LOAD		2.22	kN
CROSSBEAM CAPACITY			
NOMINAL MOMENT		1.74	kN-m
ALLOWABLE MOMENT		1.04	kN-m



CROSSBEAM DEMAND			
	POINT LOAD	DIST. LOAD	
BENDING MOMENT	0.577	0.644	kN-m
SHEAR	1.11	2.477	kN
CROSSBEAM CHECKS	POINT LOAD	DIST. LOAD	
CHECK BENDING MOMENT			
FoS	1.81	1.62	

FENCING ANALYSIS			
SECTION/DETAIL	F3		
LOADS			
DEAD LOAD			
STEEL UNIT WEIGHT		490	lb/ft ³
1.5" DIAMETER PIPE			
R1		0.75	in
R2		0.65	in
AREA		0.0031	ft ²
SECTION UNIT WEIGHT		1.50	lb/ft
1.25" DIAMETER PIPE			
R1		0.625	in
R2		0.525	in
AREA		0.0025	ft ²
SECTION UNIT WEIGHT		1.23	lb/ft
COMPONENTS DEAD LOAD			
POST SELF WEIGHT		6.87	lb
1.5" HANDRAIL LOAD		9.82	lb
1.25" GUARDRAIL LOAD		8.07	lb
TOTAL DEAD LOAD PER POST		24.76	lb
LIVE LOAD			
DISTRIBUTED LIVE LOAD		50	lb/ft
TOTAL LIVE LOAD PER POST		328.1	lb



POST CHECKS		
DEMAND		
AXIAL	24.76	lb
FLEXURAL	1076.50	lb-ft
CAPACITY		
COMPRESSION		
(KL)/r	1.10	
4.71(SQRT(E/Fy))	133.68	
	GOOD	
ELASTIC BUCKLING STRESS	235702410	lb
CRITICAL STRESS	235687342	lb
AXIAL CAPACITY	71986.60225	lb
FLEXURE		
BENDING COEFFICIENT, C _b	1	
NOMINAL MOMENT	62384.49	lb-ft
CHECKS		
AXIAL	2907.08	
FLEXURE	57.95	

GEOMETRY + MATERIAL PROPERTIES		
MAXIMUM TRIBUTARY LENGTH	6.56	ft
POST HEIGHT	3.28	ft
EMBEDMENT DEPTH	1.31	ft
1.5" DIAMETER PIPE		
R ₁	0.75	in
R ₂	0.65	in
AREA	0.0031	ft ²
SECTION UNIT WEIGHT	1.50	lb/ft
THICKNESS	0.1	in
WIDTH/THICKNESS RATIO	7.5	
RADIUS OF GYRATION	0.496	in
UNBRACED LENGTH	3.28	ft
EFFECTIVE LENGTH FACTOR	2	
YOUNG'S MODULUS	29000000	psi



	210000	MPa
YIELD STRENGTH	36000	psi
	248	MPa
PLASTIC SECTION MODULUS, Z	0.144	in ³
SLENDERNESS + COMPACTION CHECKS		
COMPRESSION	88.61	GOOD
	56.39	GOOD
FLEXURE	362.5	GOOD
EMBEDMENT CHECKS		
RAMP THICKNESS	10	cm
	3.94	in
CONCRETE STRENGTH	10	MPa
	1450.38	psi
BREAKOUT WIDTH	15	cm
	5.906	in
CONCRETE BEARING ON RAMP		
OVERTURNING MOMENT	1076.50	lb-ft
RESTORATIVE MOMENT	66487.15	lb-ft
CHECK	61.76	
POST BEARING ON CONCRETE		
OVERTURNING MOMENT	1076.50	lb-ft
RESTORATIVE MOMENT	22483.13	lb-ft
CHECK	20.89	



C.7 Construction

Tier 2

Early Strength Concrete		
	Value	Units
Final Concrete Compressive Strength	10	MPa
$f_c(t) = A \cdot \ln(t) + B$		
$A = 1.4035 \cdot \ln(B) + 2.9956$		2.67
$B = 0.005 \cdot (f_c^{2.2})$		0.79
Days, t	$f_c(t)$	
1	0.79	MPa
2	2.64	MPa
3	3.72	MPa
4	4.49	MPa
5	5.09	MPa
6	5.57	MPa
7	5.99	MPa
8	6.34	MPa
9	6.66	MPa
10	6.94	MPa
11	7.19	MPa
12	7.42	MPa
13	7.64	MPa
14	7.84	MPa
15	8.02	MPa
16	8.19	MPa
17	8.35	MPa
18	8.51	MPa
19	8.65	MPa
20	8.79	MPa
21	8.92	MPa
22	9.04	MPa
23	9.16	MPa
24	9.28	MPa



	25		9.38	MPa
	26		9.49	MPa
	27		9.59	MPa
	28		9.69	MPa
Flexure #1				
$f_c(3) =$			3.72	MPa
Steel Reinforcing Yield Strength, f_y			275	MPa
Effective width, b	0.4		0.4	m
Reinforcing Steel Area, A_s	0.00057		0.00057	m ²
Compressive Block Width, a	0.124		0.124	m
Reinforcing depth, d	0.625		0.625	m
Nominal Flexural Capacity, M_n	88.27		88.27	kN*m
Hoisting Sag, h_{hoist}	1.953		1.953	m
Mainspan angle, θ	0.23		0.22	radians
Handrail backstay angles	0.41		0.39	radians
P_h , cable weight	29.20		29.20	kN
P_h , hand, cable	25.87		24.56	kN
P_v , hand, cable	86.25		100.26	kN
Tower Offset	0.1		0.1	m
Tower Height	1.5		1.5	m
Factored Moment from Cable Load	8.56		8.20	kN*m
Reduction Factor, Φ	0.9		0.9	
$\Phi * M_n$ Reduced Moment Capacity	79.45		79.45	kN*m
LRFD Requirement Met?	YES		YES	
Reinforcement				
Modulus of Rupture, f_r			1.022	Mpa
$1.33 * M_u$	11.38		10.90	kN*m
Section Modulus, s			0.0327	m ³
Modified M_{cr}			35.78	kN*m
Sufficient Reduced Moment Capacity?	YES		YES	
Flexure #2				
$f_c(14) =$			7.84	MPa
Steel Reinforcing Yield Strength, f_y			275	MPa
Effective width, b	0.4		0.4	m



Reinforcing Steel Area, A_s	0.00057	0.00057	m ²
Compressive Block Width, a	0.059	0.059	m
Reinforcing depth, d	0.625	0.625	m
Nominal Flexural Capacity, M_n	93.36493611	93.36493611	kN*m
Hoisting Sag, h_{hoist}	1.953	1.953	m
Mainspan angle, θ	0.23	0.22	radians
Handrail backstay angles	0.41		radians
P_h , cable weight	29.20	29.20	kN
P_h , hand, cable	25.87	24.56	kN
P_v , hand, cable	86.25	100.26	kN
Tower Offset	0.1	0.1	m
Tower Height	1.5	1.5	m
Factored Moment from Cable Load	8.56	8.20	kN*m
Reduction Factor, Φ	0.9	0.9	
$\Phi * M_n$ Reduced Moment Capacity	84.03	84.03	kN*m
LRFD Requirement Met?	YES	YES	
Reinforcement			
Modulus of Rupture, f_r		1.48	Mpa
$1.33 * M_u$	11.38	10.90	kN*m
Section Modulus, s		0.0327	m ³
Modified M_{cr}		48.41	kN*m
Sufficient Reduced Moment Capacity?	YES	YES	

Construction Sag Calculation			
w_{cable}		0.14	kN/m
construction sag		0.03	%
construction ΔH		1.73	m
P_h		32.92	kN
P_{max_single}	8.96	8.23	kN
$P_{t_back_h}$	13.28	13.36	kN
$P_{v_back_h}$	5.24	5.05	kN
$P_{t_back_w}$	14.23	14.33	kN



Pv_back_w	4.88	4.91	kN
Pover	10.79	150.10	kN
Panchor	67.03	67.03	kN
Vs	10.12	9.97	kN
Vn	77.82	217.13	kN
FS	7.69	21.78	kN
FS req	1.5	1.5	
check	OK	OK	
Pramp	129.25	351.14	kN
Pactive	80.60	55.13	kN
Ph_tower	6.49	20.55	kN
Ph_anchor	26.43	12.37	kN
Rs	113.52	88.04	kN
Rn	196.29	418.18	kN
FS	1.73	4.75	kN
FS req	1.5	1.5	
check	OK	OK	

Winch Analysis			
P winch	29.4	29.4	kN
P single cable	8.96	8.23	kN
Winch/Cable	3.28	3.57	

Erection Hook Analysis			
As_#5	0.0002	0.0002	m ²
Fy	275000	275000	kpa
Hook capacity	110	110	kN
P single cable	8.96	8.23	kN
FS required	3	3	
FS actual	12.28	13.37	
Check	OK	OK	



C.8 Additional Checks

Tier 2

Water Buoyancy Effect on Uplift

Water Buoyancy considerations For Right Abutment		
HWL	100	elevation
Right Anchor	99.86	elevation
Volume of Anchor under HWL	0.4644	m ³
Volume Overburden under HWL	0.0267	m ³
bouyant force	10.6243956	kN
new resisting force	265.64	
Factor of Safety	1.47	
FS required	1.25	
Check	OK	



Appendix D: Drawing Set

D.1 Title + General Notes

RIO COILOLO SUSPENDED BRIDGE

GPS COORDINATES	19°10'0.70" S, 64°40'12.5" W	DESIGN DATA:
COUNTRY	BOLIVIA	ENGINEERS IN ACTION, 2022 BRIDGE BINDER VOLUME 2.
DEPARTMENT	CHUQUISACA	DESIGN LOADS:
MUNICIPALITY	ZUDANEZ	DEAD LOAD = 1.00 kN/m ²
COMMUNITY	COILOLO	LIVE LOAD _{PRIMARY} = 3.43 kN/m ²
SPAN	57.8 METERS	LIVE LOAD _{SECONDARY} = 4.07 kN/m ²
		WIND LOAD = 0.50 kN/m

GENERAL NOTES:

BRIDGE CONSTRUCTION SHALL BE EXECUTED BY THE MEANS AND METHODS STATED IN THE ENGINEERS IN ACTION, 2022 BRIDGE BINDER VOLUME 3.

CONCRETE:
 PORTLAND CEMENT (ASTM C150, TYPE I OR TYPE II) SHALL BE USED. CEMENT MUST BE USED WITHIN 60 DAYS OF PURCHASE.
 WATER SHALL BE CLEAN, CLEAR, AND FREE OF HARMFUL MATERIAL.
 COARSE AGGREGATE SHALL BE COMPRISED OF GRAVEL (CRUSHED LIMESTONE, GRANITE, OR GRAVEL), NO GREATER THAN 2.5 cm IN DIAMETER. MATERIAL SHALL BE CLEAN AND FREE OF DEBRIS.
 FINE AGGREGATE SHALL BE CLEAN, DRY SAND GRADED WITH A 4mm SIEVE BEFORE MIXING WITH CEMENT.

REINFORCEMENT:
 ALL REINFORCEMENT SHALL BE MINIMUM GRADE 280 (GRADE 40) WITH A YIELD STRENGTH OF 275 MPa (40 ksi).
 RIBBED STEEL SHALL BE USED FOR ALL REINFORCING BARS INCLUDING SUSPENDERS.
 ALL REINFORCEMENT SHALL BE SUPPORTED BY CONCRETE BLOCKS OR STEEL CHAIRS TO AVOID CONTACT WITH GROUND OR FORMS.

MASONRY:
 BLOCKS SHALL BE FREE OF CRACKS AND CHIPS. THERE SHALL BE NO DEFORMATIONS. USED BLOCK IS NOT PERMITTED.
 MASONRY UNITS SHALL BE WET BEFORE APPLYING MORTAR.
 MAINTAIN A CONSISTENT JOINT THICKNESS OF 15mm+- 5mm. JOINTS BETWEEN BLOCKS SHALL BE COMPLETELY FILLED.
 STAGGER BLOCKS IN RUNNING BOND PATTERN.

CABLE:
 CABLE IN PERMANENT CONTACT WITH THE GROUND SHALL BE COVERED WITH PLASTIC PIPE AND FILLED WITH GROUT OR COATED WITH TAR.
 CLAMPS SHALL BE DROP FORGED AND NOT MALLEABLE.

TIMBER:
 TIMBER SHALL BE FREE OF KNOTS, HOLES, AND SPLITS.
 WOOD SCREWS AND NAILS SHALL BE GALVANIZED.

UNIT WEIGHTS:
 STEEL = 7850 kg/m³ (490 lb/ft³)
 CONCRETE = 2400 kg/m³ (150 lb/ft³)
 TIMBER = 900 kg/m³ (56 lb/ft³)
 BROKEN ROCK = 1900 kg/m³ (119 lb/ft³)
 MASONRY = 2100 kg/m³ (131 lb/ft³)
 SOIL = 1800 kg/m³ (112 lb/ft³)

FACTOR OF SAFETY FOR SLIDING AND UPLIFT = 1.5
FACTOR OF SAFETY FOR CABLE CAPACITY = 3.0

DECK SHALL CLEAR FREEBOARD ENVELOPE WITH A MINIMUM FREEBOARD OF 2.00 METERS.

PROVIDE (6) DROP FORGED CABLE CLAMPS SPACED AT 15 cm OC. MAX TORQUE TO 225 ft-lb. PER HANDRAIL CABLE AT EACH ANCHOR.
 PROVIDE (6) DROP FORGED CABLE CLAMPS SPACED AT 15 cm OC. MAX TORQUE TO 225 ft-lb. FOR THE WALKWAY CABLE AT EACH ANCHOR.

INDEX:

- 1 TITLE + GENERAL NOTES
- 2 LAYOUT
- 3 B0-3G-60B LEFT ABUTMENT DETAILS (CUSTOM)
- 4 B0-3G-60A RIGHT ABUTMENT DETAILS (CUSTOM)
- 5 A4 ANCHOR DETAILS
- 6 T4 TOWER DETAILS
- 7 W3 WALKWAY DETAILS W/ TIMBER NAILER
- 8 C1 STEEL CROSSBEAM DETAILS
- 9 F3 APPROACH RAMP DETAILS

		REV	DESCRIPTION	DATE	ISSUED BY	<small> THESE DRAWINGS ARE PROVIDED FOR THE USE OF THIS PROJECT. ANY CONDITIONS THAT REQUIRE CHANGES FROM THE PLAN MUST BE COMMUNICATED TO THE ENGINEER FOR APPROVAL PRIOR TO CONSTRUCTION. ANY CHANGES MADE IN ANY MANNER MUST BE CALLED OUT AND ACCORDING TO THE SPECIFIC CONDITIONS AND LOCAL STANDARDS. </small>	<small> USE OF THESE PLANS FOR ANY OTHER PURPOSE SHALL BE AT THE USER'S RISK. ENGINEERS IN ACTION AND ITS OFFICES HOLD ENGINEERS IN ACTION LIABILITY TO THE USER AND ALL LIABILITY. </small>	<small> PROJECT: COILOLO RIVER BRIDGE COUNTRY: BOLIVIA DEPARTMENT: CHUQUISACA MUNICIPALITY: ZUDANEZ </small>	<small> PROGRAM MANAGER: ETHAN GINGERICH ENGINEERING RECORD DATE: 2/28/2023 DRAWN BY: GHF CHECKED BY: JCH APPROVED BY: XXX REVIEWED BY: XXX </small>	COILOLO RIVER BRIDGE SUSPENDED BRIDGE TITLE + GENERAL NOTES	<small> PROJECT NUMBER DRAWING NUMBER </small>



D.2 Layout

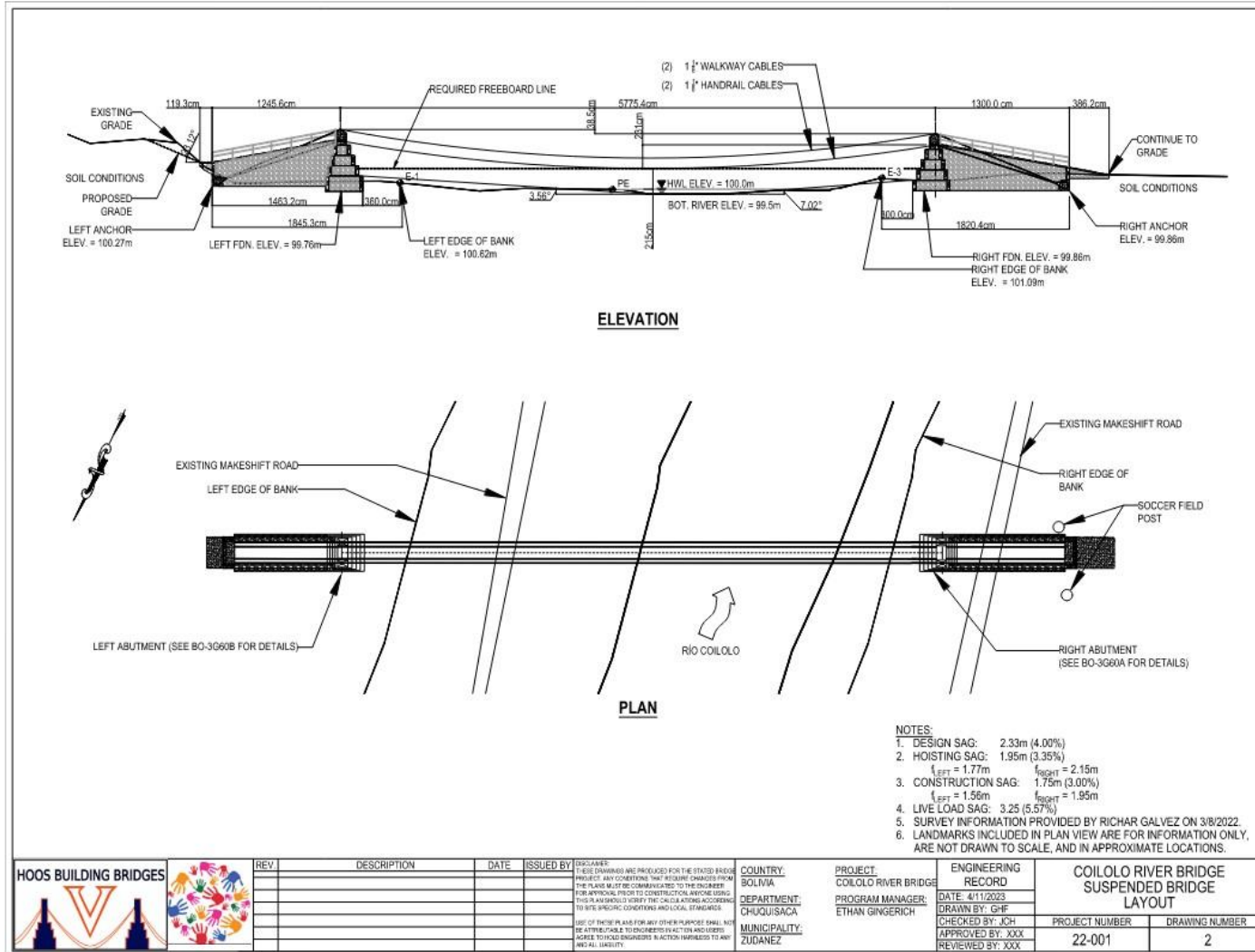



D.3 Left Abutment Details

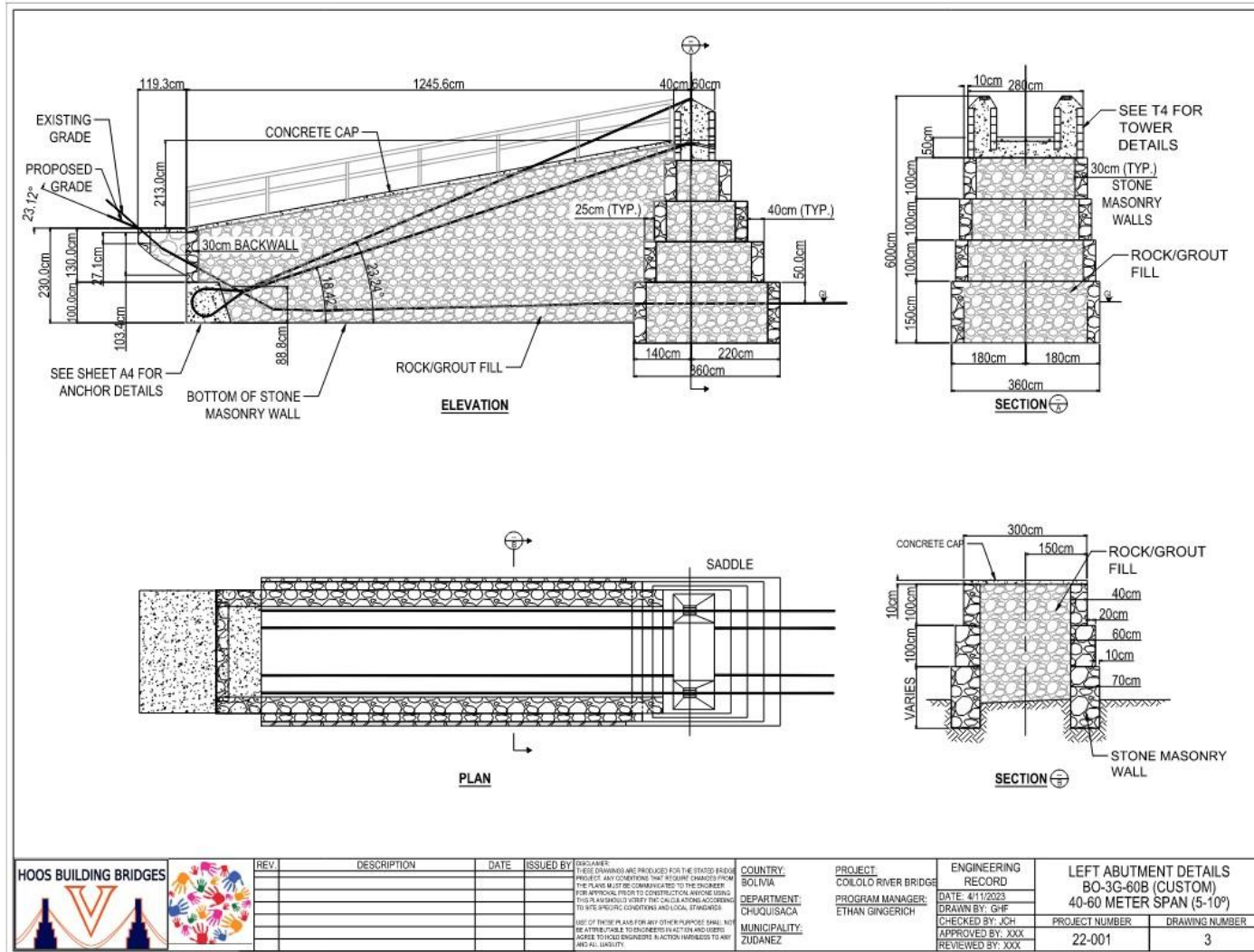

REV.	DESCRIPTION	DATE	ISSUED BY	ENGINEER

DESIGNER:
 THESE DRAWINGS ARE PRODUCED FOR THE STATED BRIDGE PROJECT. ANY CONDITIONS THAT REQUIRE CHANGES FROM THE PLANS MUST BE COMMUNICATED TO THE ENGINEER FOR APPROVAL PRIOR TO CONSTRUCTION. ANYONE USING THIS PLAN SHALL VERIFY THE CALCULATIONS ACCORDING TO SITE SPECIFIC CONDITIONS AND LOCAL STANDARDS.
 NONE OF THESE PLANS FOR ANY OTHER PURPOSE SHALL NOT BE ATTRIBUTED TO ENGINEERS IN ACTION AND USERS AGREE TO HOLD ENGINEERS IN ACTION HARMLESS TO ANY AND ALL LIABILITY.

COUNTRY:
 BOLIVIA
 DEPARTMENT:
 CHUQUISACA
 MUNICIPALITY:
 ZUDANEZ

PROJECT:
 COLOLO RIVER BRIDGE
 PROGRAM MANAGER:
 ETHAN GINGERICH

ENGINEERING
 RECORD
 DATE: 4/11/2023
 DRAWN BY: GHF
 CHECKED BY: JCH
 APPROVED BY: XXX
 REVIEWED BY: XXX

LEFT ABUTMENT DETAILS BO-3G-60B (CUSTOM) 40-60 METER SPAN (5-10°)	
PROJECT NUMBER	DRAWING NUMBER
22-001	3



D.4 Right Abutment Details

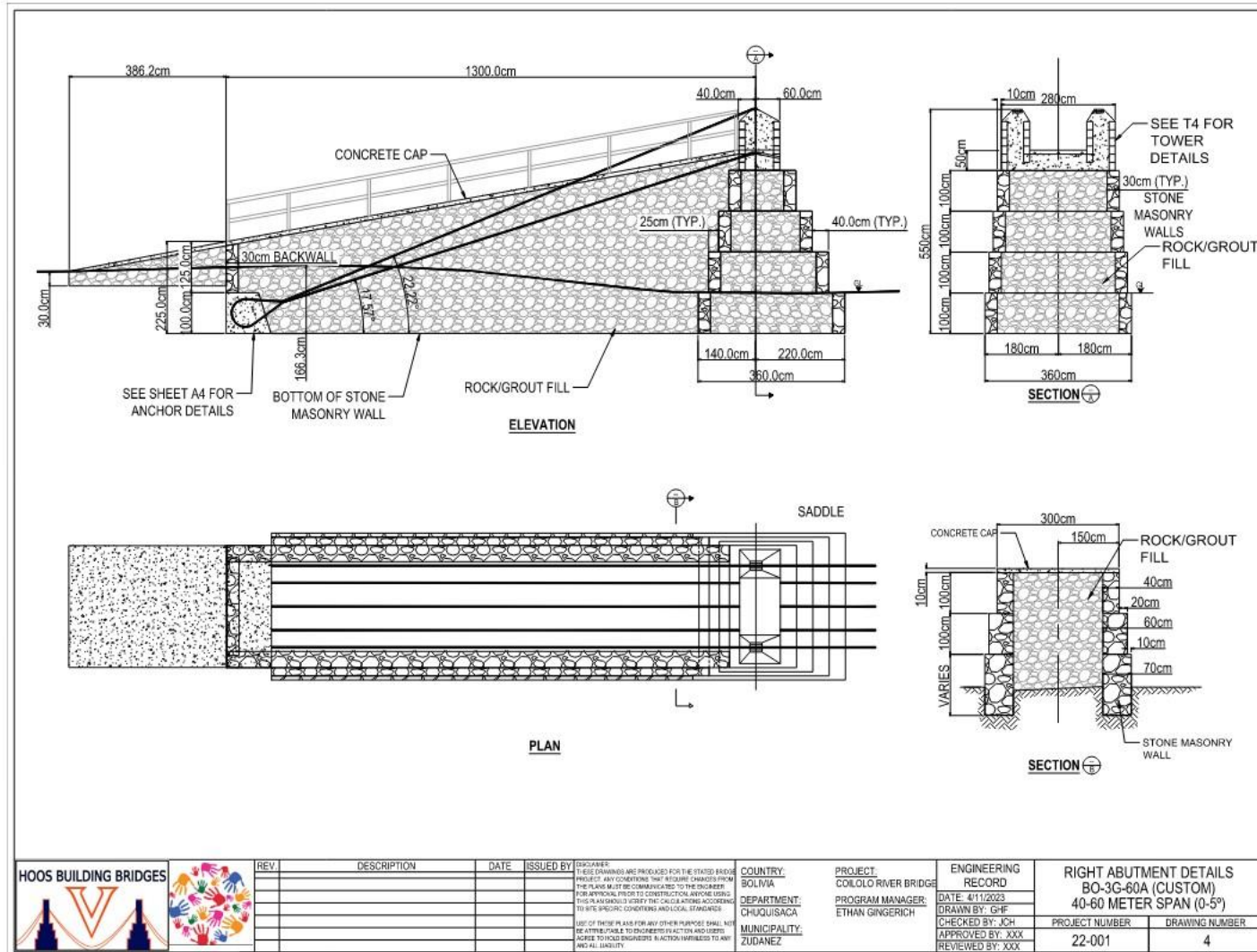



D.5 Anchor Details

PLAN

REINFORCING BARS (PER ANCHOR)				
NAME	BAR SIZE (mm)	LENGTH (cm)	QUANTITY	LENGTH (m)
A01	19 (#6)	285	4	11.4
A02	16 (#5)	220	2	4.4
A03	13 (#4)	225	10	22.5

ITEM	QUANTITY
CONCRETE	2.85m ³
FLEXIBLE PLASTIC TUBING x 250cm	VARIABLES

A02

A03

SECTION

NOTES:

- SEE ENGINEERS IN ACTION BRIDGE BINDER FOR CONSTRUCTION GUIDELINES.
- 7.5cm CLEAR COVER SHALL BE PROVIDED FOR ALL REINFORCING AND PLASTIC TUBING.
- ERECTION HOOK AND TUBING OPTIONAL FOR ANCHOR DETERMINED TO BE NON-ADJUSTABLE OR FIXED.
- REINFORCING BAR DIMENSIONS ARE TAKEN TO OUTSIDE OF BAR.

REV	DESCRIPTION	DATE	ISSUED BY	DESIGNER
0	ISSUED FOR CONSTRUCTION	04/11/2022	BKK	THESE DRAWINGS ARE PRODUCED FOR THE STATED BRIDGE PROJECT. ANY CONDITIONS THAT REQUIRE CHANGES FROM THIS PLAN MUST BE COMMUNICATED TO THE ENGINEER FOR APPROVAL PRIOR TO CONSTRUCTION. ANYONE USING THIS PLAN SHOULD VERIFY THE CALCULATIONS ACCORDING TO THE SPECIFIC CONDITIONS AND LOCAL STANDARDS.

COUNTRY:
BOLIVIA

DEPARTMENT:
CHUQUISACA

MUNICIPALITY:
ZUDANEZ

PROJECT:
COILOLO RIVER BRIDGE

PROGRAM MANAGER:
ETHAN GINGERICH

ENGINEERING RECORD

DATE: 04/11/2022
DRAWN BY: BKK

CHECKED BY:	PROJECT NUMBER	DRAWING NUMBER
APPROVED BY:	22-001	5 - A4
REVIEWED BY:		



D.6 Tower Details

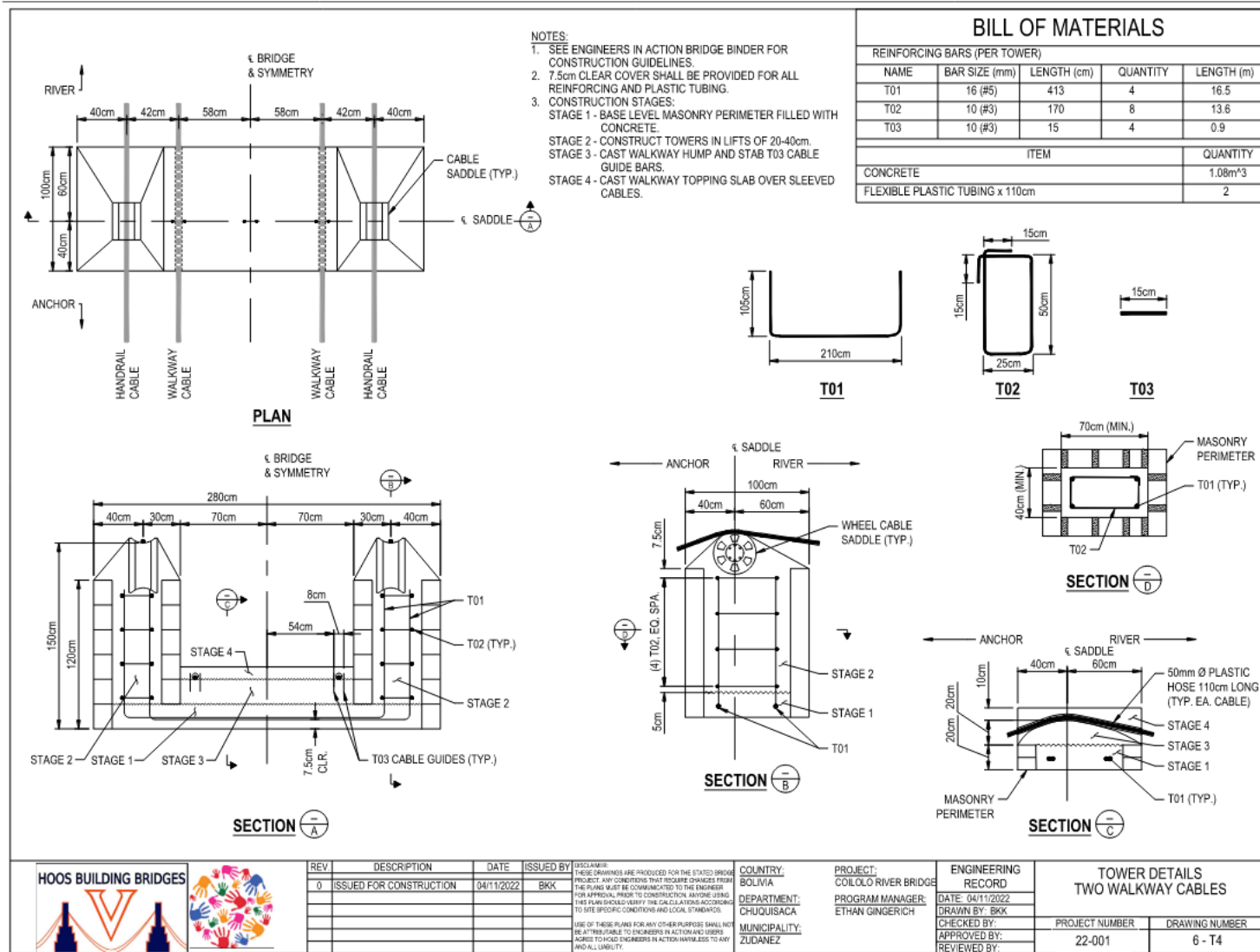



D.7 Walkway Details

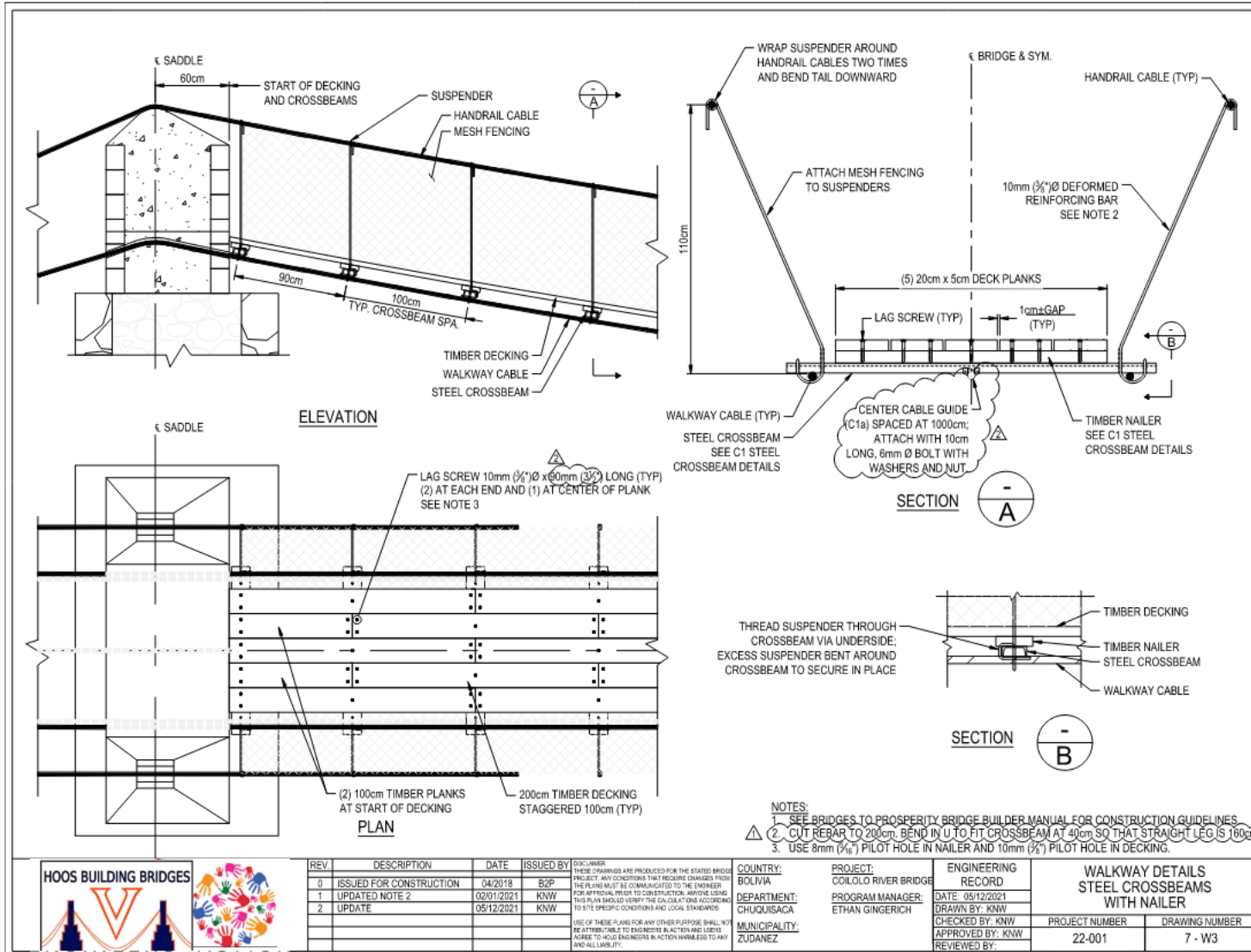



D.8 Steel Crossbeam Details

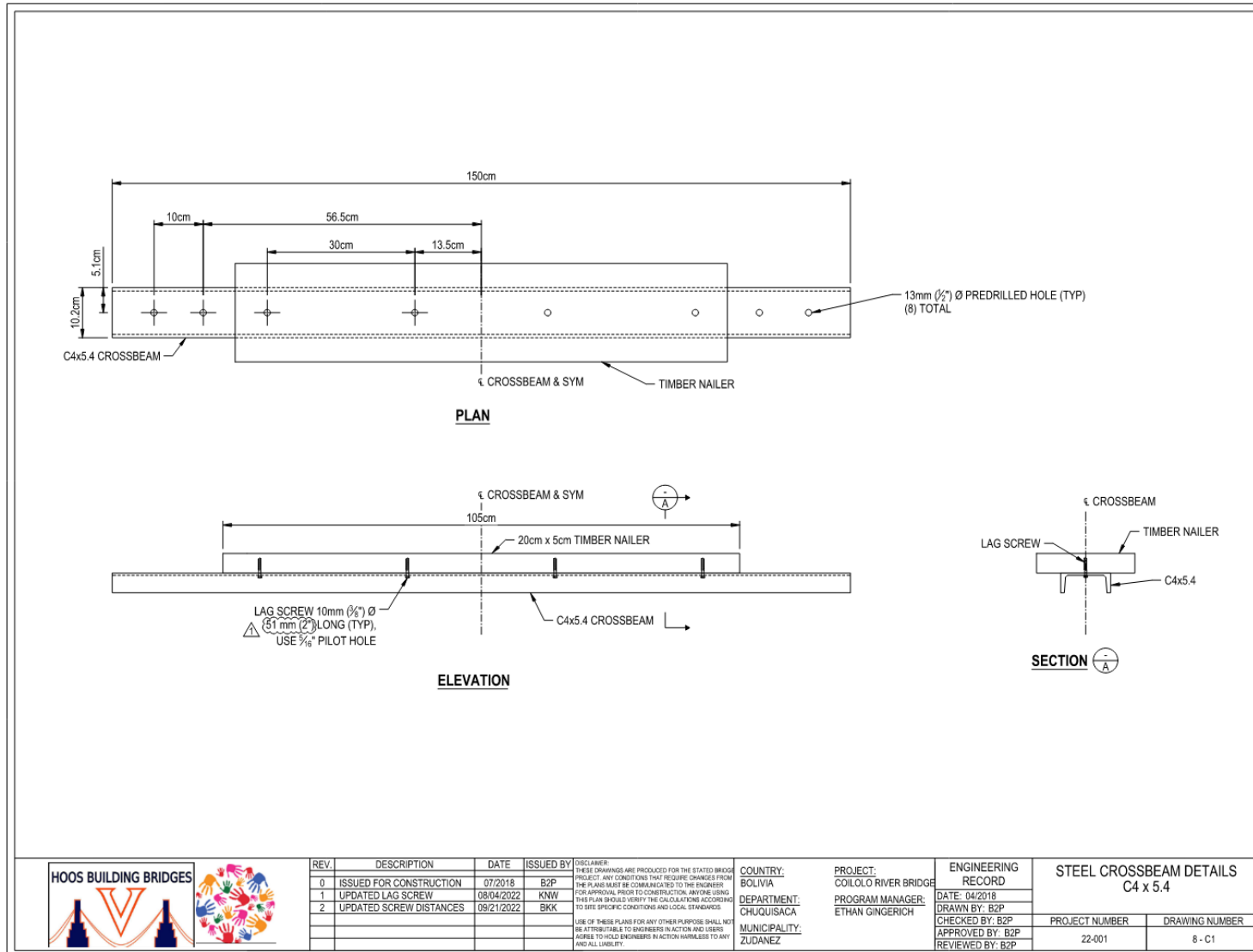



D.9 Approach Ramp Details

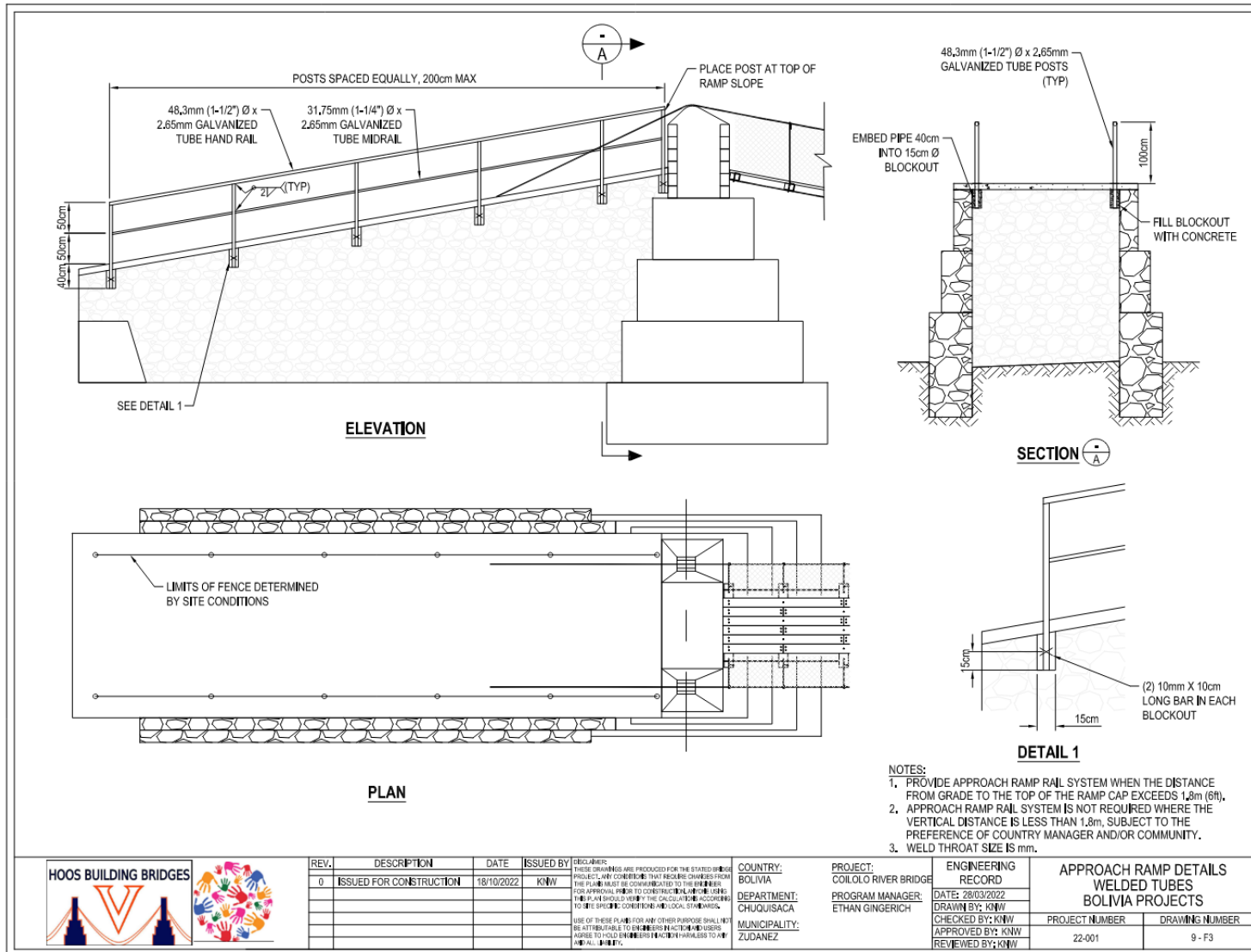



Appendix E: Construction Plan

E.1 Excavation Drawings

PHASE I: FOUNDATION

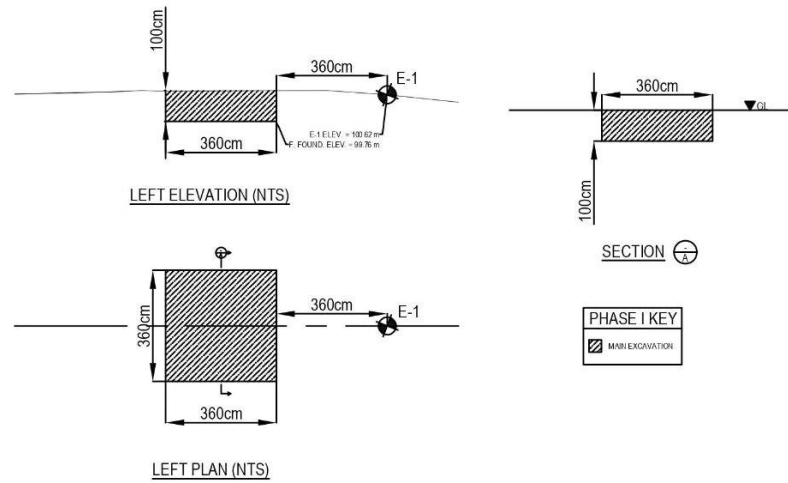

PHASE II: APPROACH WALLS AND ANCHOR

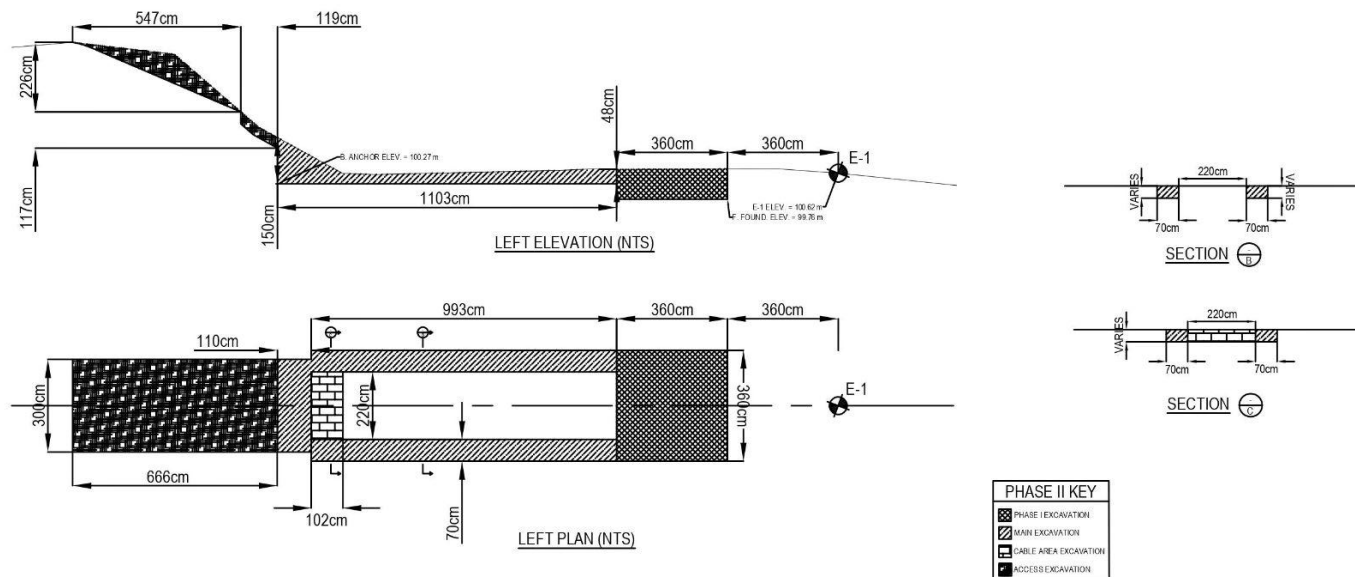



PHASE I: FOUNDATION

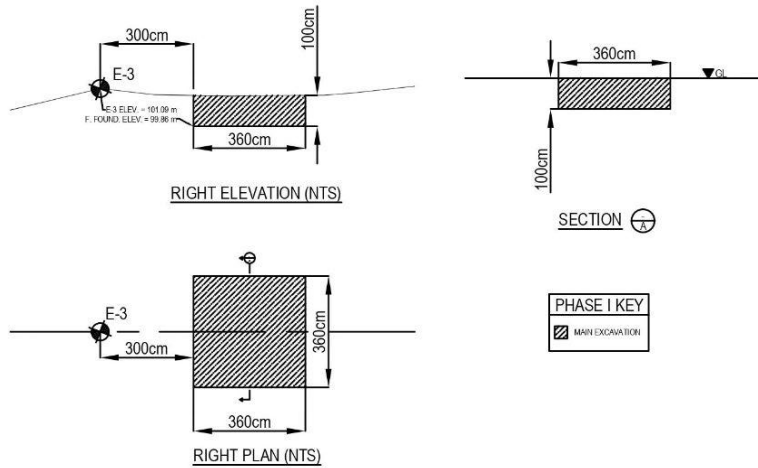

PHASE II: APPROACH WALLS AND ANCHOR

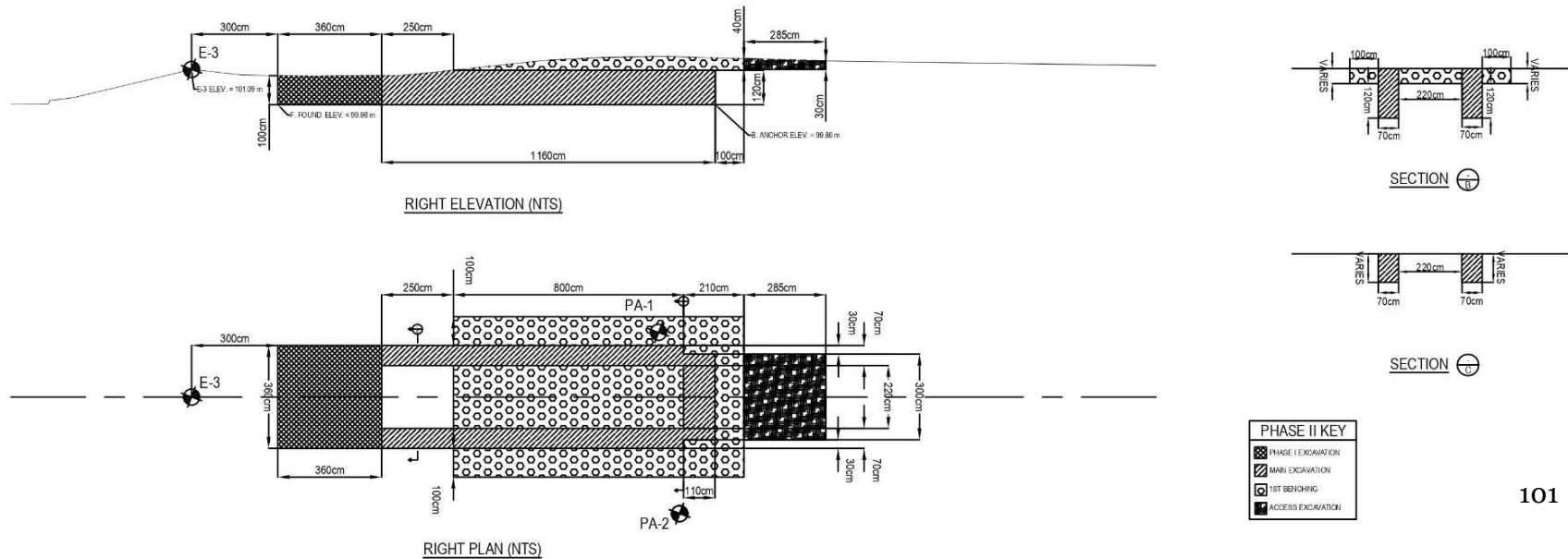

E.2 Construction Schedule

Float Activities			
Task	First Start Date	Required Completion Date (EOD)	Number of Available Work Days
Prepare Tower Materials: Cut & Bend Rebar	May 22	June 5	13
Prepare Tower Materials: Attach Stirrups / Prepare Cage	May 22	June 5	13
Prepare Anchor Materials: Cut & Bend Rebar	May 22	June 13	20
Prepare Anchor Materials: Attach Stirrups / Prepare Cage	May 22	June 13	20
Decking Preparation: Cut, Drill, and Paint Crossbeams	May 22	June 25	30
Decking Preparation: Cut, Drill, and Attach Nailers	May 22	June 25	30
Decking Preparation: Cut & Bend Suspender Rebar	May 22	June 25	30
Decking Preparation: Sort & Drill Deck Boards	May 22	June 27	32
Decking Preparation: Paint Fences	May 22	June 29	34



WEEKLY CONSTRUCTION SCHEDULE: COILOLO RIVER PEDESTRIAN BRIDGE									
Project Week #		1 (May 15 - May 21)		Primary Tasks:					Site Prep / Excavation
Key Equipment:		100 meter measuring tape, level, automatic level, string line, plumb bob, spray paint, stakes, hammer, machete, tripod, survey rod, excavation bars, picks, shovels, carpentry nails, buckets, water tube, PPE							
		MON	TUES	WED	THURS	FRI	SAT	SUN	
		May 15	May 16	May 17	May 18	May 19	May 20	May 21	
T A S K S	Site Clearing/Mark Layout								
	Left Foundation Excavation								
	Right Foundation Excavation								
P E R S O N N E L	EIA Mason 1								
	EIA Mason 2								
	Hold Point								
	Community Forepersons								
	# Community Laborers (Heavy Const.)								
	# Community Laborers (Site Prep)								
	Total Hours Worked								
U V A R O L E S	Project Manager								
	Cultural Relations Manager								
	Bridge Designer								
	Construction Manager								
	Safety Manager								
	Quality Control Manager								
	Fundraising Manager								
	Media Manager								
Bridge Corps Member									



WEEKLY CONSTRUCTION SCHEDULE: COILOLO RIVER PEDESTRIAN BRIDGE									
Project Week #		2 (May 22 - May 28)			Primary Tasks:				Foundation / Tiers
Key Equipment:		Shovels, buckets, masonry tools, construction square, level, plumb bob, string line, tape measure, spray paint, stakes, truck, drum mixer, generator, shovels, wheelbarrow, concrete blanket, tamping rod, PPE							
		MON	TUES	WED	THURS	FRI	SAT	SUN	
		May 22	May 23	May 24	May 25	May 26	May 27	May 28	
T A S K S	Left Foundation Masonry								
	Left Foundation Fill/Cap								
	Right Foundation Masonry								
	Right Foundation Fill/Cap								
	Left Tier 1 Masonry						Half-Day		
	Left Tier 1 Fill/Cap								
P E R S O N N E L	EIA Mason 1								
	EIA Mason 2								
	Hold Point								
	Community Forepersons								
	# Community Laborers (Heavy Const.)								
	# Community Laborers (Site Prep)								
	Total Hours Worked								
U V A R O L E S	Project Manager								
	Cultural Relations Manager								
	Bridge Designer								
	Construction Manager								
	Safety Manager								
	Quality Control Manager								
	Fundraising Manager								
	Media Manager								
Bridge Corps Member									



WEEKLY CONSTRUCTION SCHEDULE: COILOLO RIVER PEDESTRIAN BRIDGE								
Project Week #		3 (May 29 - June 4)			Primary Tasks: Tiers			
Key Equipment:		Shovels, buckets, masonry tools, construction square, level, plumb bob, string line, tape measure, spray paint, stakes, truck, drum mixer, generator, wheelbarrow, concrete blankets, tamping rod, scaffolding, PPE						
		MON	TUES	WED	THURS	FRI	SAT	SUN
		May 29	May 30	May 31	June 1	June 2	June 3	June 4
T A S K S	Right Tier 1 Masonry		Half-Day					
	Right Tier 1 Fill/Cap							
	Left Tier 2 Masonry			Half-Day				
	Left Tier 2 Fill/Cap							
	Right Tier 2 Masonry				Half-Day			
	Right Tier 2 Fill/Cap							
	Left Tier 3 Masonry					Half-Day		
	Left Tier 3 Fill/Cap							
	Right Tier 3 Masonry						Half-Day	
	Right Tier 3 Fill/Cap							
P E R S O N N E L	EIA Mason 1							
	EIA Mason 2							
	Hold Point							
	Community Forepersons							
	# Community Laborers (Heavy Const.)							
	# Community Laborers (Site Prep)							
	Total Hours Worked							
U V A R O L E S	Project Manager							
	Cultural Relations Manager							
	Bridge Designer							
	Construction Manager							
	Safety Manager							
	Quality Control Manager							
	Fundraising Manager							
	Media Manager							
Bridge Corps Member								



WEEKLY CONSTRUCTION SCHEDULE: COILOLO RIVER PEDESTRIAN BRIDGE									
Project Week #		4 (June 5 - June 11)		Primary Tasks:		Towers / Excavation			
Key Equipment:		Shovels, buckets, masonry tools, construction square, level, plumb bob, string line, tape measure, spray paint, wire cutters, saw, saw blades, hacksaw, stakes, truck, drum mixer, generator, wheelbarrow, concrete blankets, grinder, jig, pipe, angle grinder, angle grinder discs, scaffolding, PPE							
		MON	TUES	WED	THURS	FRI	SAT	SUN	
		June 5	June 6	June 7	June 8	June 9	June 10	June 11	
T A S K S	Left Anchor, Ramp Wall, & Cable Area Excavation								
	Right Anchor, Ramp Wall, & Cable Area Excavation								
	Left Tower - Complete Base						Flex Day		
	Right Tower - Complete Base								
	Left Tower - Place Brick Formwork & Rebar								
	Right Tower - Place Brick Formwork & Rebar								
	Left Tower - Pour Concrete Fill								
	Right Tower - Pour Concrete Fill								
	Left Tower - Embed Saddles / Walkway Hump								
	Right Tower - Embed Saddles / Walkway Hump								
P E R S O N N E L	EIA Mason 1								
	EIA Mason 2								
	Hold Point								
	Community Forepersons								
	# Community Laborers (Heavy Const.)								
	# Community Laborers (Site Prep)								
	Total Hours Worked								
U V A R O L E S	Project Manager								
	Cultural Relations Manager								
	Bridge Designer								
	Construction Manager								
	Safety Manager								
	Quality Control Manager								
	Fundraising Manager								
	Media Manager								
Bridge Corps Member									



WEEKLY CONSTRUCTION SCHEDULE: COILOLO RIVER PEDESTRIAN BRIDGE									
Project Week #		5 (June 12 - June 18)		Primary Tasks:					Anchor / Approach Walls
Key Equipment:		Shovels, pickaxes, buckets, angle grinder, masonry tools, construction square, level, plumb bob, string line, tamping rod, tape measure, spray paint, wire cutters, concrete blankets, truck, slump cone, wheelbarrow, mallet, cement mixer, hammer, scaffolding, PPE							
		MON	TUES	WED	THURS	FRI	SAT	SUN	
		June 12	June 13	June 14	June 15	June 16	June 17	June 18	
T A S K S	Left Abutment - Construct Ramp Wall Foundations								
	Right Abutment - Construct Ramp Wall Foundations								
	Left (Adjustable) Anchor - Place Cage & Pour				Concrete Curing				
	Right (Fixed) Anchor - Place Cage & Pour					Concrete Curing			
	Left Abutment - Approach Walls								
	Right Abutment - Approach Walls								
P E R S O N N E L	EIA Mason 1								
	EIA Mason 2								
	Hold Point								
	Community Forepersons								
	# Community Laborers (Heavy Const.)								
	# Community Laborers (Site Prep)								
	Total Hours Worked								
U V A R O L E S	Project Manager								
	Cultural Relations Manager								
	Bridge Designer								
	Construction Manager								
	Safety Manager								
	Quality Control Manager								
	Fundraising Manager								
	Media Manager								
	Bridge Corps Member								



WEEKLY CONSTRUCTION SCHEDULE: COILOLO RIVER PEDESTRIAN BRIDGE									
Project Week #		6 (June 19 - June 25)			Primary Tasks:				Cables / Approaches
Key Equipment:		Cable Hoisting: winch, torque wrench (small, medium and large), sockets, automatic level, tripod, 4-foot level, measuring tape, string line, permanent marker, spray paint, duct tape, generator, grinder, clamps, walkie talkies, PPE Ramp Construction: shovels, buckets, construction square, level, plumb bob, string line, tamping rod, tape measure, truck, concrete blankets, cement mixer, PPE							
		MON	TUES	WED	THURS	FRI	SAT	SUN	
		June 19	June 20	June 21	June 22	June 23	June 24	June 25	
T A S K S	Drape Cables, Hand Hoist, and Clamp								
	Cable Hoisting Preparation (f-value & autolevel)								
	Hoist Cables			Relax Cables					
	Right Abutment - Tar/Coat Cables and Clamps								
	Right Abutment - Grout Tubes								
	Set Cable Sag & Clamp					Observe & Adjust Cables			
	Right Abutment - Ramp Fill								
	Left Abutment - Ramp Fill (Part 1)*								
	Final Sag Set Cable Clamping								
P E R S O N N E L	EIA Mason 1								
	EIA Mason 2								
	Hold Point								
	Community Forepersons								
	# Community Laborers (Heavy Const.)								
	# Community Laborers (Site Prep)								
	Total Hours Worked								
U V A R O L E S	Project Manager								
	Cultural Relations Manager								
	Bridge Designer								
	Construction Manager								
	Safety Manager								
	Quality Control Manager								
	Fundraising Manager								
	Media Manager								
	Bridge Corps Member								



WEEKLY CONSTRUCTION SCHEDULE: COILOLO RIVER PEDESTRIAN BRIDGE								
Project Week #		7 (June 26 - July 2)			Primary Tasks: Decking / Cables			
Key Equipment:		Masonry tools, buckets, shovels, wood saw, hack saw, blades, drill press, drill bits, drill charger and batteries, impact driver, sockets, socket wrench, hammers, measuring tape, pipes for bending suspenders, markers, wire cutters, harness, fall protection, wire cutters, pliers, cement mixer, PPE						
		MON	TUES	WED	THURS	FRI	SAT	SUN
		June 26	June 27	June 28	June 29	June 30	July 1	July 2
T A S K S	Assemble & Launch Swings							
	Install Decking							
	Wrap Suspenders							
	Install Fencing							
	Confirm Dead Load Sag							
	Left Abutment - Tar/Coat Cables and Clamps							
	Left Abutment - Grout Tubes							
P E R S O N N E L	EIA Mason 1							
	EIA Mason 2							
	Hold Point							
	Community Forepersons							
	# Community Laborers (Heavy Const.)							
	# Community Laborers (Site Prep)							
	Total Hours Worked							
U V A R O L E S	Project Manager							
	Cultural Relations Manager							
	Bridge Designer							
	Construction Manager							
	Safety Manager							
	Quality Control Manager							
	Fundraising Manager							
	Media Manager							
Bridge Corps Member								



WEEKLY CONSTRUCTION SCHEDULE: COILOLO RIVER PEDESTRIAN BRIDGE								
Project Week #		8 (July 3 - July 9)		Primary Tasks: Approaches				
Key Equipment:		Masonry tools, buckets, shovels, wood saw, hack saw, blades, drill, drill bits, impact driver, sockets, socket wrench, two-pound pipe hammers, markers, measuring tape, wire cutters, PPE						
		MON	TUES	WED	THURS	FRI	SAT	SUN
		July 3	July 4	July 5	July 6	July 7	July 8	July 9
T A S K S	Left Abutment - Ramp Fill (Part 2)							
	Left Abutment - Hillside Excavation and Access Ramp							
	Right Abutment - Access Ramp							
	Right Approach - Topping Slab				Concrete Curing			
	Right Approach - Install Handrail Posts							
	Left Approach - Topping Slab					Concrete Curing		
	Left Approach - Install Handrail Posts							
	Left & Right Approach - Paint Handrail Posts							
	Bridge Inauguration/Opening							
P E R S O N N E L	EIA Mason 1							
	EIA Mason 2							
	Hold Point							
	Community Forepersons							
	# Community Laborers (Heavy Const.)							
	# Community Laborers (Site Prep)							
	Total Hours Worked							
U V A R O L E S	Project Manager							
	Cultural Relations Manager							
	Bridge Designer							
	Construction Manager							
	Safety Manager							
	Quality Control Manager							
	Fundraising Manager							
	Media Manager							
	Bridge Corps Member							



E.3 Work Breakdown Structure

Category	Task	Duration
Material Collection		2 weeks to Several Months
Construction Layout		2 Days
	Site Clearing/Preparations	1 Day
	Mark Excavation	1 Day
Excavation		1 to 3 Weeks
	Left Foundation Excavation	3 Days
	Right Foundation Excavation	3 Days
	Left Anchor, Ramp Wall, & Cable Area Excavation	3 Days
	Right Anchor, Ramp Wall, & Cable Area Excavation	3 Days
	Left Hillside Excavation and Backfill	2 Days
Foundation and Tiers		1 to 4 Weeks
	Left Foundation Construction	4 Days
	Right Foundation Construction	4 Days
	Left Tier 1 Construction	2 Days
	Right Tier 1 Construction	2 Days
	Left Tier 2 Construction	2 Days
	Right Tier 2 Construction	2 Days
	Left Tier 3 Construction	2 Days
	Right Tier 3 Construction	2 Days
Towers		1 Week
	Prepare Tower Materials: Cut & Bend Rebar	N/a
	Prepare Tower Materials: Attach Stirrups / Prepare Cage	N/a
	Left Tower - Complete Base	1 Day
	Right Tower - Complete Base	1 Day
1 day delay between masonry and po	Left Tower - Place Brick Formwork & Rebar	1 Day
1 day delay between masonry and po	Right Tower - Place Brick Formwork & Rebar	1 Day
	Left Tower - Pour Concrete Fill	1 Day
	Right Tower - Pour Concrete Fill	1 Day
	Left Tower - Embed Saddles / Walkway Hump	1 Day
	Right Tower - Embed Saddles / Walkway Hump	1 Day
Anchors		3 to 5 Days
	Prepare Anchor Materials: Cut & Bend Rebar	N/A
	Prepare Anchor Materials: Attach Stirrups / Prepare Cage	N/A
Ensure 3 day cure time prior to hoisti	Left (Adjustable) Anchor - Place Cage & Pour	1 Day
	Right (Fixed) Anchor - Place Cage & Pour	1 Day
Begin Ramp Walls		1 to 3 Days
	Left Abutment - Construct Ramp Wall Foundations	1 Day
	Right Abutment - Construct Ramp Wall Foundations	1 Day
Cable Hoisting		4 Days
	Drape Cables, Hand Hoist, and Clamp	1 Day
	Cable Hoisting Preparation (f-value, autolevel, winch)	1 Day
	Hoist Cables	1 Day
	Relax Cables	1 Day
	Set Cable Sag & Clamp	1 Day
	Observe & Adjust Cables (24hr waiting period)	1 Day
	Final Sag Set Cable Clamping	1 Day
After Decking is Installed	Left Abutment - Tar/Coat Cables and Clamps	1 Day
Immediately	Right (Fixed) Abutment - Tar/Coat Cables and Clamps	1 Day
After Decking is installed	Confirm Dead Load Sag	1 Day
After Decking is Installed	Left Abutment - Grout Tubes	1 Day
	Right Abutment - Grout Tubes	1 Day
Approach Ramp Construction		4 Days to 2 Weeks
	Left Abutment (Adjustable) - Approach Walls	2 Days
	Right Abutment (Fixed) - Approach Walls	2 Days
	Left Abutment (Adjustable) - Ramp Fill (Part 1)	1 Day
	Right Abutment (Fixed) - Ramp Fill	2 Days
After Decking is Installed	Left Abutment (Adjustable) - Ramp Fill (Part 2)	2 Days
	Left Approach - Topping Slab	1 Day
	Right Approach - Topping Slab	1 Day
	Left Approach - Install Handrail Posts	1 Day
	Right Approach - Install Handrail Posts	1 Day
	Right Abutment - Access Ramp	1 Day
	Left & Right Approach - Paint Handrail Posts	1 Day
	Walkway Slab Curing	2 Days
Walkway Finishes		1 to 3 Weeks
	Decking Preparation: Cut, Drill, and Paint Crossbeams	N/a
	Decking Preparation: Cut, Drill, and Attach Nailers	N/a
	Decking Preparation: Cut & Bend Suspender Rebar	N/a
	Decking Preparation: Sort & Drill Deck Boards	N/a
	Decking Preparation: Paint Fences	N/a
	Assemble & Launch Swings	3 Days
	Install Decking	3 Days
	Wrap Suspenders	1 Day
	Install Fencing	2 Days
	Bridge Inauguration / Opening Ceremony	1 Day



E.4 EIA Bridge Project Comparisons - Activity Duration Estimates

Uruchini Suspended Bridge	
Span Length	86 m
Approx. Total Excavation	110 m ³
Activity	
Duration	
Crossbeam Installation	3 days
Decking Installation	3 days
Fencing Installation	2 days
Excavation	10 days
Crossbeam Ratio	28.7 m/day
Decking Ratio	28.7 m/day
Fencing Ratio	43 m/day
Excavation Ratio	11 m ³ /day

Maphoveleni Suspended Footbridge	
Span Length	111 m
Approx. Total Excavation	75 m ³
Activity	
Duration	
Crossbeam Installation	5 days
Decking Installation	5 days
Fencing Installation	3 days
Excavation	12 days
Crossbeam Ratio	22.2 m/day
Decking Ratio	22.2 m/day
Fencing Ratio	37.0 m/day
Excavation Ratio	6.3 m ³ /day

Tfutfuka-Mvubula Suspended Footbridge	
Span Length	32 m
Approx. Total Excavation	76 m ³
Activity	
Duration	
Crossbeam Installation	2 days
Decking Installation	2 days
Fencing Installation	4 days
Excavation	13 days
Crossbeam Ratio	16.0 m/day
Decking Ratio	16.0 m/day
Fencing Ratio	8.0 m/day
Excavation Ratio	5.8 m ³ /day