

Technical Report

Nutritional Protein: Plant Based Chicken Nuggets

Avery Baker, Brett Hogan, Tayler Newton, & Isabelle Sowers

Advisor: Eric Anderson

CHE 4474: Process Synthesis, Modelling, and Control

April 5, 2024

On our honor, we have neither given nor received unauthorized aid on this
assignment.

Table Of Contents

SECTION 1: EXECUTIVE SUMMARY	5
SECTION 2: INTRODUCTION	6
2.1 Background	6
SECTION 3: DISCUSSION	8
3.1 Design Basis and Method	8
3.2 Block 1: Sesame Oil Extraction	12
3.2.1 Material Balance	12
3.2.2 Seed Preparation Equipment Design	16
3.2.3 Oil Extraction Design	20
3.2.4 Pump Design	22
3.2.5 Heat Exchanger Design	23
3.2.6 Ancillary Equipment Design	24
3.2.7 Energy Requirements	25
3.3 Block 2: Seed Cake Fermentation and Lactic Acid Extraction	30
3.3.1 Material Balance	30
3.3.2 Fermenter Design	35
3.3.3 Separations Design	38
3.3.4 Grinding Equipment Design	43
3.3.5 Tank Sizing	44
3.3.6 Pump Design	45
3.3.7 Energy Requirements	46
3.3.8 Heat Exchanger Design	47
3.4 Block 3: Yeast Extract Production	49
3.4.1 Material Balance	49
3.4.2 Yeast Extract Fermenter Design	52
3.4.3 Autolysis Design	60
3.4.4 Separations design	61
3.4.5 Pump Design	63
3.4.6 Heat Exchange Design	65
3.5 Block 4: Final Mixing	69
3.5.1 Material Balance	69
3.5.2 Equipment Design	71
3.5.3 Pump Design	73
3.5.4 Energy Requirements	74
SECTION 4: FINAL DESIGN RECOMMENDATION	77
4.1 Sesame Oil Extraction Final Design	77

4.1.1 Final Product Specifications	77
4.1.2 Equipment	78
4.1.2 Stream Table	81
4.1.3 Energy Demand	83
4.2 Sesame Cake Fermentation Final Design	85
4.2.1 Final Product Specifications	85
4.2.2 Equipment	86
4.2.3 Stream Table	88
4.2.4 Energy Demand	90
4.3 Yeast Extract Fermentation Final Design	91
4.3.1 Final Product Specifications	91
4.3.2 Equipment	91
4.3.3 Stream Table	93
4.3.4 Energy Demand	95
4.4 Mixing and Product Formation Final Design	96
4.4.1 Final Product Specifications	96
4.4.2 Block 4 Equipment	97
4.4.3 Stream Table	99
4.4.4 Energy Demand	101
SECTION 5: ECONOMICS	103
5.1 Fixed Capital Investment	103
5.2 Variable Operating Costs	111
5.3 Fixed Operating Costs	115
5.4 Revenues	116
5.5 Cash Flow Analysis	117
5.5.1 Scenario 1: Baseline	117
5.5.2 Scenario 2: No lactic acid recovery	118
5.5.3 Scenario 3: Sesame seed oil production only	119
5.5.4 Scenario 4: No yeast extract block	121
SECTION 6: ENVIRONMENTAL, HEALTH, AND SOCIAL CONSIDERATIONS	123
6.1 Chemical Hazards and Compatibility	123
6.2 Equipment Failure	129
6.3 Environmental Concerns, Inherently Safer Design	132
6.4 Waste Management	133
6.5 Social Considerations	136
SECTION 7: CONCLUSION AND RECOMMENDATIONS	138
7.1 Go/No Go Decision	138
7.2 Future Work	139

7.3 Acknowledgement	140
SECTION 8: TABLE OF NOMENCLATURE	141
SECTION 9: REFERENCES	142
SECTION 10: APPENDIX	158
Appendix 3.1.01 Sedimentation Tank Calculations	158
Appendix 3.2.01 Power Requirements Calculation for Sesame Cake Digestor	161
Appendix 3.2.02 Sample Calculation for centrifuge for fermented seed cake	163
Appendix 3.2.03 Van't Hoff Osmotic Pressure Calculation	164
Appendix 3.2.04 Example Flooding Velocity Calculation	165
Appendix 3.4.01. Sample calculation using Arrhenius rule for liquid mixture viscosity of seed fermenter feed	166
Appendix 3.4.02. Sample calculation of mixture density for feed into seed fermenter	167
Appendix 3.4.03. Sample calculation of target kLa for seed fermenter	168
Appendix 3.4.04. Sample calculation of design kLa and power requirements for seed fermenter	169
Appendix 3.4.05 Mixing Tank Energy Calculation	171
Appendix 3.5.01. Frying Oil Uptake Calculation	172
Appendix 5.1.01 Pricing of Aerobic Yeast Fermenters	173

SECTION 1: EXECUTIVE SUMMARY

As concerns over climate change have grown, so has the market of plant-based meats. Plant-based meats require less water and energy to produce per pound compared to meats such as beef and poultry, making them a favorable alternative. The majority of existing plant-based meats are soy-based, which is an allergen concern. This report details the design of a manufacturing plant to produce plant-based chicken nuggets using sesame seeds as the feedstock in place of soy. Oil pressing and solvent extraction is used to remove the oil from the seeds, and the remaining seed cake is fermented to improve flavor and nutritional value. A side product of this process is toasted sesame seed oil. The final product is fried nuggets that are packaged in bulk, and sold wholesale at \$4 per pound. They are composed of fermented sesame seed cake, yeast extract, hydrogenated vegetable oil, seasoning, methylcellulose, batter, breading, and canola oil. Each year, 3.3MM pounds of plant-based nuggets are produced, along with 900,000 pounds of sesame oil. Sesame oil is also sold wholesale at \$7.40 per pound. The total capital cost of this project is \$4.9MM, and annual operating cash flows are \$2.9MM in the first ten years and \$2.8MM in the final ten years of the expected plant lifetime. Additional economic scenarios are outlined in this report that led to the final design decision. The proposed final design eliminates the yeast extract fermentation and lactic acid recovery processes because of high expenses associated with these sections. This is a moderate to high risk project, since the vegan chicken nugget market is small and success heavily relies on customer approval. The final design is viable, with a gross profit of \$3.76MM per year and 65.70% internal rate of return.

SECTION 2: INTRODUCTION

2.1 Background

An increasing number of individuals in the U.S. are actively seeking ways to help the environment. Research conducted by the Pew Research Center highlights this growing concern, revealing that 83% of U.S. adults are making conscious efforts to reduce the impacts of climate change (Funk, 2016). One notable approach gaining popularity is the transition from a meat-containing diet to a plant-based diet, with nearly 6% of people in the U.S. now identifying as vegetarian, a significant increase from the 1% who did in 1994 (Visé, 2022).

While many associate the proliferation of plant-based products with new-age diets, plant-based meats are far from new. Tofu, tempeh, and seitan were used as a high-protein ingredient for many dishes as early as the second century (Butz, 2021). However, these products do not attempt to replicate traditional meats, which is a major complaint for those moving towards a plant-based diet (Ignaszewski & Pierce, 2023). Companies have recently begun to develop meat substitutes that more closely replicate the textures and tastes of meats, many of which have become household names, such as Beyond or Impossible Burgers. While beef has been the focus for many companies, mainly to replicate burgers, other products are being made by manufacturers such as Amy's Kitchen, MorningStar, and Gardein. They offer a wide range of plant-based products, from chicken nuggets to fish, and even cheeses (IMARC, 2022).

Industry projections within the chicken analog commercial space are optimistic, as the plant-based chicken market alone is projected to grow 18.4% in the next 10 years (Choudhury, 2023). Since the market is heavily soy-based, the proposed alternative protein source can be derived through extraction of sesame seed media (Krososky, 2023). Although sesame and soy

are now both major food allergens in the U.S. (Califf, 2023), there are limited meat alternatives that are not soy-based, restricting options for people with plant-based diets and a soy allergy.

Currently, the majority of sesame seeds produced are extracted for oil, leaving a protein rich sesame meal byproduct that has been historically and primarily used as animal feedstock. The byproduct sesame meal is roughly 50% protein and is considered a complete protein, and the ratio of amino acids mimic those found in the human body (Wei et al., 2022). In the proposed process, this side product may be used to generate a high-protein product that can fill a gap within the plant-based industry.

Furthermore, plant-based meats are often criticized for their high cost, with the average plant-based protein being 38% more expensive than traditional meats (Rogers, 2023). Chicken analogs in particular exhibit a substantial price increase, soaring up to 104% when compared to traditional chicken products. To address this economic disparity, there is a pressing need for the development of a cost-effective alternative. The proposed approach entails leveraging high-value byproducts to mitigate the overall expenses associated with the production process.

SECTION 3: DISCUSSION

3.1 Design Basis and Method

The process can be split into four main blocks: seed oil extraction, seed cake fermentation and lactic acid separation, yeast extract processing, and mixing to create the end protein product. Each of these blocks can be further divided into a series of unit operations to produce the necessary physical, chemical, and purifications required to produce value added food products (Figure 3.1.1). After a brief overview of all blocks, each block will be described in detail individually.

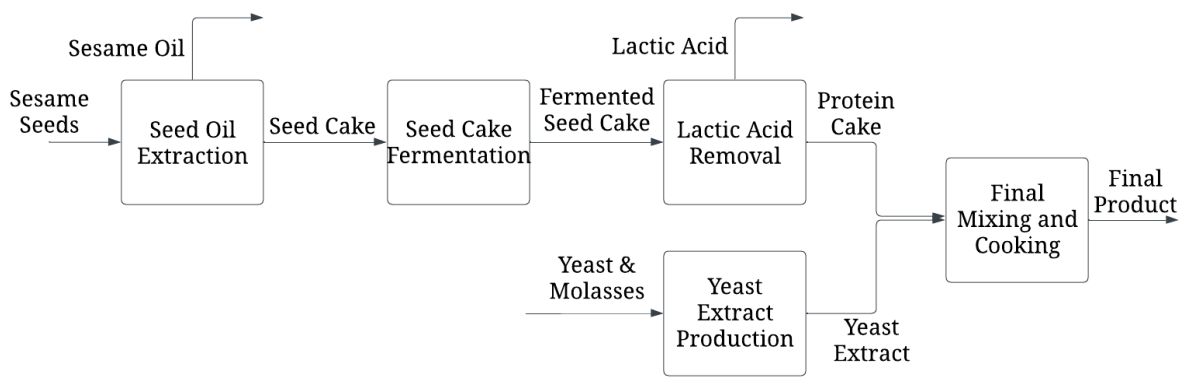

Figure 3.1.1. Overview of General Process

The first block will process raw sesame seeds and separate them into oil and seed cake. This process utilizes solvent-based extraction to gain the highest yield of sesame seed oil. A pretreatment consisting of toasting and grinding enhances the flavor and increases yield. Toasting the seeds is a batch process, typically done in a rotating drum oven, with seeds requiring approximately 1.5-3 hrs of roasting time at 100-150°C (Demirbas Machine, n.d.). The

seeds are then mechanically ground into smaller pieces before proceeding to the solvent extraction. Grinding releases much of the oils from the seeds, so oil will be collected at this point.

The ground seeds are added in batches to a vessel containing approximately a 6:1 mass ratio of butane to seeds and constantly stirred for optimal yield (Elkhaleefa & Shigidi, 2015). Models for this reaction are provided by Osman et al. (1984) where various methods were used to model the reaction. Yields for a solvent based extraction of sesame oils are typically around half the dried seed mass (Mujtaba et al., 2020). To remove the butane from the oil, flash separation is used, where the butane can be recycled. Given the potentially harmful properties of butane, safety measures and regulations have been put in place. Specifically, the World Health Organization (WHO) has set a limit of 500 mg/kg as the acceptable threshold and therefore, the primary objective of the separation process will be to maintain levels significantly below this established limit (Cravotto et al., 2022). The seed solids that are also produced from this product are then sent to the second block.

The leftover seed cake will be used in the protein product, but must undergo additional processing to improve flavor and digestibility. This is the primary task of the second block. Experiments have shown that *Lactobacillus plantarum*, a fermentable bacterium typically found in milk and other fermented food products, can be cultured in seed cake in reasonable timeframes (12-24 hrs) (Khalfallah et al., 2022). The results of said fermentation greatly reduce fiber and sugar content, while only resulting in small protein losses in the medium. To ferment sesame cake with *Lactobacillus plantarum*, the seed cake must be clarified through centrifugation, and is then inoculated with the bacterium for 12-24 hours. Because the fermentation occurs with

Lactobacillus, lactic acid is produced as a significant byproduct. This chemical is flavor active and must be separated from the final product.

Following the fermentation, downstream processing is needed to reduce this lactic acid produced, and further improve the consumer experience. A study in consumer reactions to chicken preservation techniques found that the upper limit of preference of lactic acid concentration in chicken products is 1 g/L. (Van der Marel et al., 1989). The expected lactic acid output from fermentation is roughly 6 g/L, so any removal process must yield 85% of the lactic acid (Khalfallah et al., 2022). Acidic centrifugation was found to remove the majority of solids from a fermentation broth with minimal lactic acid entrainment within the pellet (Kumar et al., 2020). The outputs of this separation are a protein rich solid which can be neutralized to form the base of the nugget and a solution containing lactic acid.

Lactic acid itself is a valuable waste product, and an investigation was conducted on isolating this compound as an additional product. A summary of lactic acid retrieval methods recommended an extraction as the most scalable option (Li et al., 2021). This purification involves two steps, with ultrafiltration to remove the remaining proteins, and a reactive extraction of the lactic acid binding to amine groups in an organic solution. This extraction separates the lactic acid from sugars and salts also found in the fermentation broth. By using this method, the common pitfall of other precipitation separations producing useless gypsum waste can be avoided (Kumar et al., 2020). Extraction solvents can be reused once purged of lactic acid, which allows for a significantly reduced environmental footprint compared to precipitation methods. Small amounts of solvent mixing inhibit the waste water from the extraction from being reused as fermentation broth. Once the lactic acid is removed from the organic solvent, it is

concentrated using an evaporator. Lactic acid is heat stable at boiling temperatures, so no degradation of lactic acid product will occur during this phase (Komesu et al., 2017).

Yeast extract will be added to the fermented sesame product to enhance the savory or “umami” flavor, similar to traditional meats (Tomé, 2021). To create yeast extract, brewer’s yeast, or *Saccharomyces cerevisiae* is used. The yeast is subjected to a fermentation process in which sugar cane molasses is added as a carbon source to increase the number of yeast cells (Win et al., 1996). Once the culture has reached its desired biomass, the yeast cells are centrifuged to remove the liquid medium. Subsequently, they undergo disruption and separation to eliminate their cell walls (Tao et al., 2023). To maintain the flavor profile of the yeast extract, an autolysis of the yeast will be used. An increase in temperature will begin the autolysis process, and after the release of yeast extract, another centrifuge will be used to remove the debris (Tanguler & Erten, 2008). This solution is then sent to the final mixing stage.

Fermented sesame cake and yeast extract from the process is combined with methylcellulose, hydrogenated oil and a seasoning blend. Hydroxypropyl-Methylcellulose (HPMC) serves as a thickening agent in the nuggets. In food products, the methoxy fraction of HPMC should be 26-33% (Chemical Book, 2023). The recommended maximum intake of HPMC is 5 mg/kg of body weight per day (Burdock, 2007). This mixture is extruded to create a chicken substitute that is then battered, breaded, and fried to form a final plant-based meat product, a nugget analog. The nuggets pass through a cooling tunnel and blast freeze tunnel to increase shelf life before being packaged.

3.2 Block 1: Sesame Oil Extraction

3.2.1 Material Balance

The first block removes oil from sesame seeds through both mechanical and extractive methods to produce a seed cake for further processing. Figure 3.2.1 illustrates the overall process for this block. Imported whole sesame seeds are fed into an Air Screen Cleaner (X1.01), which has a capacity of approximately 11,000 lb/hour and results in a purity of 98-99% for the output seeds. Only a small fraction of the initial seeds should need to be removed in this cleaning step (Harden,1983). The Air Screen cleaner can remove up to 90% of the impurities, resulting in 99% purity of the sesame seeds Julite (n.d.). Using 425 lbs/hour of sesame seeds as the feed, the flow of impurities in the waste stream and of cleaned seeds into the process can be estimated.

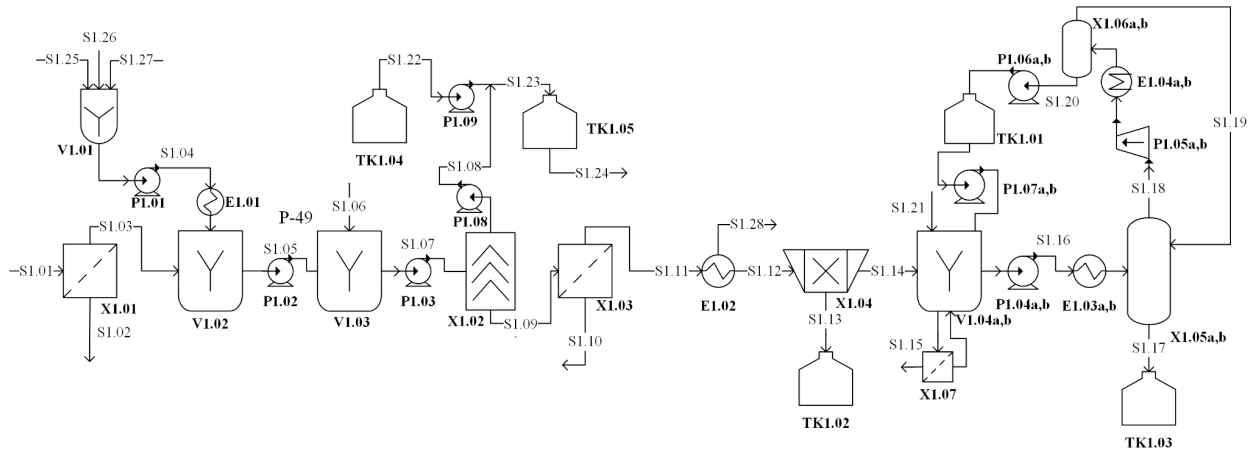

Figure 3.2.1 Process flow diagram for the seed oil extraction block

The clean seeds must be soaked in lye to soften and loosen the hulls, making the physical hulling process easier. The lye soaking process is completed batch wise in a mixing tank (V1.02), with a soaking time of 40 minutes at 35°C (Moharram, et al., 1984.). The lye in this process will be heated to 30°C utilizing a heat exchanger (E1.01), and it is assumed that the energy from the impeller is enough to maintain the temperature at 30°C throughout the soaking process. The lye

mixture (3% Na_2CO_3 and 0.04% NaOH) is prepared in tank V1.01 and pumped (P1.01) into the mixing tank where it is agitated with the whole sesame seeds. Based on experimentation by Gojiya and Gohil, the seeds absorb moisture such that the moisture content of the seed after soaking is approximately 40% (Gojiya & Gohil, 2022). Additionally, it was assumed that the seeds absorbed the lye solution in the same concentration as the surrounding solution. Dissolving the NaOH and Na_2CO_3 is an exothermic reaction, which is leveraged to achieve the desired 30°C for soaking. This process will be completed once every hour to soak the seeds that have accumulated since the previous batch.

The seeds/lye stream is then washed with water in a mixing tank (V1.03). Process water will be used to uphold the food grade standards. It is assumed that equal masses of water and seeds will be used, and that the mass of the seeds and water are not significantly affected by their interaction. This seed slurry is then fed through a sedimentation tank (X1.02) to isolate the seeds. Recycling the lye would require an intermediate reheating step before the next batch, therefore lye will not be recycled. It is assumed that any remaining lye will be sufficiently removed from the product upon hull removal. The lye waste stream is then combined with 96% sulfuric acid from a holding tank, TK1.04 via turbulent flow to neutralize the waste stream, making it non-hazardous waste. The resulting acid base reactions decompose the sodium bicarbonate within the lye solution producing water and sodium sulfate $\text{Na}_2\text{SO}_4(\text{aq})$ as a wastewater stream which is held in a holding tank, TK1.05, until disposal.

Sesame seeds hulls contain a significant amount of oxalates, and Americans have a preference for sesame oil produced from hulled seeds (Carbonell et al., 2009). The physical process to remove the hull utilizes a mechanical rotary sieve, X1.03, to scalp the hull from the seed (Rotary Sifters, n.d.). Sieving also acts as an additional cleaning step, as the sifting action

can remove undesired foreign objects that may still be present. The hull accounts for 15-29% of the whole sesame seed (Güngör, 2004); 22% weight loss is used for this process.

The seeds are then toasted (E1.02) to enhance the flavor of the sesame seeds and subsequent products. The toasting also acts to reduce the water content of the sesame seeds to approximately 1%. Additionally, toasting increases the oil yield in the solvent extraction phase. The oil yield continues to increase as the roasting temperature increases, however, the seeds become brittle and fragile when roasted at high temperatures ($>200^{\circ}\text{C}$) and the oil quality noticeably decreases. Prioritizing the oil yield through manipulation of roasting time and temperature indicates a maximum yield when the sesame seeds are roasted for 10 minutes at 180°C . The seeds are roasted continuously via a conveyor belt that feeds the seeds through the toaster for a 10 minute residence time.

The toasted seeds are then mechanically pressed to extract the sesame oil (X1.04). Elkhaleefa & Shigidi (2015) found the initial mechanical extraction of sesame oil typically results in a 33.5% yield after the seeds are cleaned, hulled, and toasted. The remaining sesame meal is fed into the process for further oil extraction with butane and the extracted sesame oil feeds into a holding tank, TK1.02.

The butane extraction process and following flash separation are both completed batchwise. A conservative estimate for the required contact time between the sesame meal and butane is 6 hours with a butane to seed mass ratio of 6:1 and a stirring speed of 700 RPM (Elkhaleefa & Shigidi, 2015). The exact oil yield for these conditions is not reported, but extrapolation of provided graphs provides a conservative estimate of a 35% yield again, after the seeds are processed. After the sesame meal has been extracted with butane, the remaining seed cake is filtered from the butane/oil mixture, X1.07, and moved to the second block for further

processing. The butane/sesame oil mixture passes through a heat exchanger to reach roughly 180°C (E1.03a,b), and is then separated through adiabatic flash at a pressure of 0.4 atm (X1.05a,b). The vaporized butane is collected and condensed for recycling by utilizing a system of compressors (P1.05a,b) and secondary flash drums (X1.06a,b). The recovered butane flows into a storage tank (TK1.01) where it will be utilized in the process. The separated oil is stored in a holding tank, TK1.03, where it awaits shipping. The two processes are run simultaneously, so the butane inventory must be double the butane required for the extraction process.

Table 3.2.1 shows the overall material balance for the block. The main inlets consist of the seeds, lye, and water; sesame hulls, oils, and seed cake are the main outlets.

Table 3.2.1 Seed oil block Stream Table

Component	In (lb/hr)	Out (lb/hr)
Sesame Seeds (Whole)	423.97	
Impurities		4.00
Lye	1297.47	
Wastewater		2180.73
Water	839.46	
96% Sulfuric Acid	43.8	
Hulls		92.34
Sesame Oil (grade 1)		102.64
Seed cake		135
Sesame Oil (grade 2)		72.93
Water (toaster)		16.37
Total	2604.70	2604.01

3.2.2 Seed Preparation Equipment Design

Air Screen Cleaner

Sesame seeds will be fed into the process on a conveyor belt where they are first processed by Julite's Air Screen Cleaner with Gravity Table and Vibration Grading (X1.01) to remove debris and underdeveloped/damaged seeds. A pneumatic elevator lifts the seeds into the air screen where they are filtered and dust is removed. The gravity table separates out heavy and light impurities, employing differences in density as indicated by either settling rate or terminal velocity. The seeds are screen cleaned again to remove remaining impurities (Bestsort Technology, n.d.). Vibration grading removes impurities based on differences in size (Lin, 2023). A screw feeder is then used to transport the seeds to the next step in the process. This runs nearly constantly, but has 2 weeks of downtime built in for the year.

Mixers

The first mixing tank (V1.01) dissolves NaOH and Na₂CO₃ in cooling water, creating the lye solution. The seeds soak in the lye solution for roughly 40 min, and because the lye is not recycled, a new batch of lye must be prepared hourly. The quantities of NaOH and Na₂CO₃ added are small enough that it is expected that an employee can add the solids to the mixer. The mixture requires 151 gal of process water to be combined with 38 lbs Na₂CO₃ and 0.5 lbs NaOH to reach the desired lye concentration. A 215 gal stainless steel mixing tank from Perry Biehler (n.d.) is used, and a marine propeller will be used for agitation/mixing. The tank diameter is 2.95 ft, and the impeller diameter is 11.8 inches with a blade width of 2.4 inches and length of 3 inches. The propeller operates at 50 rpm and the power required is 777 W. The rotational was chosen based on 2018 FDA regulations for dissolution testing via the paddle method.

The next stage in the process is the submersion of the hull-on sesame seeds in the lye solution (V1.02). The lye is pumped into the mixing tank for this step and the seeds are fed with a screw feeder. Another 215 gal stainless steel mixing tank from Perry Biehler is used; because solid suspension is required, a pitch blade turbine with 4 blades at a 45° angle is used. The tank and impeller dimensions are otherwise identical. This pitch blade turbine operates with a rotational speed of 73 RPM, the minimum impeller speed as calculated utilizing the Zwietering constant for solid suspension (Appendix 3.1.02). This impeller has a power requirement of 1.4 kW. The seeds remain in the lye solution for further processing, and are separated using a filter (X1.07) after the mechanical oil extraction step.

A third mixing tank (V1.03) is used for solid suspension as the lye soaked seeds are washed with process water. The process water is added all at once at a quantity of 1260 lb, bringing the mixture to 1.5% Na₂CO₃ and 0.02% NaOH. Assuming a batch size of approximately 300 gal to meet production goals, a stainless steel tank of that size from Heritage Equipment (n.d.) with a pitch blade turbine, with 4 blades at a 45° angle was utilized. This tank has a reported diameter of 3.9 feet, and the impeller diameter is 1.3 feet with turbine blades 3.1 inches in width and 3.9 inches in length. This runs nearly constantly, but has 2 weeks of downtime built in. This pitch blade turbine operates with a rotational speed of 48 RPM, the minimum impeller speed as calculated utilizing the Zwietering constant for solid suspension (Appendix 3.1.02) and requires 5.2 kW of power. The basic water/seed slurry is then pumped into a sedimentation tank to remove excess lye solution from the seeds.

The last mixing tank (V1.04 a,b) involves contacting immiscible materials, namely butane and seed meal, and requires a contact time of 6 hours. The butane is pumped into the mixer from the butane storage tank and the seed meal is screw fed. High shear rates are required

to blend immiscible liquids, so a disk turbine will be used with another 300 gal stainless steel mixing tank from Heritage Equipment (n.d.). The dimensions of this tank and impeller combination are identical to the previous tank. This disk turbine operates at 100 RPM and subsequently requires 40 kW of power. 100 RPM was chosen because it supplies sufficient mixing for this step. The sesame cake is separated from the oil/butane mixture by a filter (X1.07). Because of the volatility of the hexane and its affinity to the extracted sesame oils, it was assumed that negligible amounts of butane exited with the sesame cake. Additionally, due to the limited data available for physical properties of the seed cake, design of the filter was determined to be out of scope, and thus a system of 2 bag filters designed for benzene/hydrocarbons will be utilized (C1D1 Labs, 2023).

Holding Tanks

Two holding tanks (TK1.04-5) are required for the neutralization process of the lye waste stream from the sedimentation tank, one for storing the sulfuric acid used to neutralize and one for holding the neutralized stream. The first holding tank is for storage of the 96% sulfuric acid. The tank volume should hold 2 months worth of the necessary sulfuric acid (4,227 gal). The sulfuric acid is only used to neutralize the lye waste and is not in contact with either edible products, so the tank does not need to be food grade. While sulfuric acid is corrosive, a 5,000 gal resin polyethylene tank plastic holding tank can resist this degradation and can be used for this application (National Tank Outlet, n.d.-a).

The acid and base are first combined in the piping and neutralized via turbulent flow. The second holding tank collects the neutralized lye waste stream for testing to ensure that the sulfuric acid successfully lowers the pH of the stream to a neutral pH before waste disposal. To collect a day's worth of this waste stream, the holding tank needs to have a capacity of 6,000 gal .

A 6,000 gal storage tank made of UV stabilized resin from National Tank Outlet (n.d.-b) can be used for this process.

Sedimentation Tanks

After soaking in lye, the seeds/lye stream is washed with process water. This seeds/lye slurry is pumped into a sedimentation tank (X1.02) to isolate the seeds from the diluted lye solution. The settling tank is sourced from Alibaba (n.d.-f), and is assumed to be 100% efficient. The settling speed for the seeds, assuming a 0.0098 ft seed diameter (Darvishi, 2012), is 3.6 ft/s, and the flow speed for the tank is $2.7 * 10^{-4}$ ft/s. The seeds sink in the sedimentation tank because they are more dense than the dilute solution; the lye solution is assumed to have the same density as water, and the seeds have a density of 10.21lb/gal (Taheri-Garavand, 2009) The hydraulic retention time is expected to be 6.8 hours. See *Appendix 3.1.01* for the calculations regarding the sedimentation tank. The seeds exiting the sedimentation tank will be fed into the rotary sieve used for dehulling via conveyor belt. This runs nearly constantly, but has 2 weeks of downtime built in. The seeds absorb some of the lye solution, and it was assumed that the moisture content of the sesame seeds after soaking is approximately 40% (Gojiya & Gohil, 2022).

Rotary Sieve

The rotary sieve (X1.04) is a mechanical step that physically removes the hull from the seed after toasting/drying. The Prater Rotary Sifter from Prater Industries (n.d.) utilizes centrifugal force along with paddles and a screen to remove the sesame seed hull. Based on this model, the rotary sieve has an effective screen area of 410 in². The hulled seeds will be dispensed onto a conveyor belt to be toasted. This runs nearly constantly, but has 2 weeks of downtime built in.

Toaster

The toaster (E1.02) will toast the seeds at 180°C for 10 minutes. The toaster removes any remaining liquid from the dehulling process. The toaster will be sourced from Alibaba (n.d.-a) and has a capacity of 330 lb/hr. The toaster operates close to capacity because 310 lb/hr needs to be toasted to meet production goals. This runs nearly constantly, but has 2 weeks of downtime built in.

Oil Mill

The toasted seeds are conveyed to the mechanical oil press (X1.03) for the primary extraction of sesame oil. The Sesame Oil Expeller from Mini Oil Mills (n.d.) will be in this step. This oil mill is specifically designed for use on sesame seeds and has a capacity ranging from 1-5 tons/day, which indicates it should be suitable for this process. To meet the production targets, the oil mill will process roughly 3 tons/day of toasted sesame seeds. The resulting sesame meal is screw fed to the next processing step. This runs nearly constantly, but has 2 weeks of downtime built in.

3.2.3 Oil Extraction Design

Flash Drum

After the sesame meal is contacted with butane for a secondary oil extraction and heated to 175°C, a pressure differential will transport the butane and oil phase into the flash drum (X1.05 a,b). The flash drum, modeled using Aspen Plus, operates at 0.4 atm and will adiabatically flash separate the butane and sesame oil. A horizontal flash drum from ALSCO is used; based on the condensate load of approximately 1322 lb/hour, the VAFT-6 model will be utilized. Based on the flow rate, this extraction takes approximately 10 minutes per batch of contacted sesame meal. This flash drum is made from carbon steel, which is food safe, but has a

shorter life span than a stainless steel counterpart would. After the seed meal is removed from the pressurized extraction loop, it is assumed that the excess butane will evaporate off at the standard temperature of 25°C.

A second flash drum (X1.06 a,b) is used in the butane extraction process after the butane is compressed and cooled to ensure only liquid butane is pumped into the holding tank. The expected output of the flash drum is 100% liquid, meaning there is no top product, only a bottoms product. The butane is compressed to 5 atm and leaves the cooler at 40°C. To limit the energy required to heat the butane, the liquid butane must leave the flash at 40°C, so the flash will be isothermal. This drum and surrounding equipment was modeled in Aspen Plus, specifying the product stream conditions as 40°C and 5 atm.

Holding Tank

In this process, there are two full volumes of butane available for extraction. Because butane batches are alternated, only one extraction volume is needed to be held at a time (TK1.01). A 3,000 gal stainless steel holding tank will be sourced from DK Tank & Pipe (n.d.) to be used as the holding tank for both butane extraction volumes.

A holding tank is required for the storage of the primary sesame oil extracted mechanically (TK1.02). The process is expected to need enough storage to contain 2 weeks worth of the primary oil produced, which is roughly 34,600 lbs of sesame oil. According to Chemical Book's Sesame Oil Product Description (n.d.-b), the density of the oil is 7.67 lb/gal, storage for up to 4,520 gal of primary sesame oil will be required. A 5,000 gal HDPE holding tank will be sourced from National Tank Outlet (n.d.-a).

Another holding tank is required to store two weeks of production worth of the secondary sesame oil produced by butane extraction (TK1.03). A storage tank with roughly 3,300 gal of

sesame oil capacity is required (Chemical Book, n.d.-b). A 4,000 gallon HDPE storage tank will be sourced from Plastic-Mart (n.d).

3.2.4 Pump Design

In block 1, there are a total of 24 pumps; there are 12 primary pumps, each with a backup pump. The first four (P1.01-P1.04 a,b) are rotary pumps made of food grade stainless steel to transport slurries and higher viscosity fluids. Peristaltic pumps (P1.06a,b & P1.07a,b) are used to handle low flow. The three pumps used as part of the lye neutralization process can be made of cast iron because none of the involved streams are part of the food production system. All pumps operate under the assumption that the pump efficiency is 90%.

Pump P1.01 does not handle a slurry, nor a high viscosity liquid, yet a stainless steel rotary pump was chosen to ensure a consistent flow rate. Due to low concentrations of NaOH and Na₂CO (0.04% NaOH and 3% Na₂CO₃), it was assumed that the lye solution has a density and viscosity similar to that of water. This pump needs to produce a pressure differential of 1 atm due to the piping and heat exchanger and uses 18.22 W of power. The cost for this is \$5,700 per pump (Peters et al., 2003).

Pump P1.02 is a rotary stainless steel pump that handles a slurry of seeds and lye. The density of the solution is assumed to be 9.28 lb/gal, and a 0.5 atm pressure drop is assumed from piping. This pump uses 10.5 W of power and will cost \$5,700 per pump (Peters et al., 2003).

Pump P1.03 also handles a seed slurry, so another stainless steel rotary pump will be required. The concentration of seeds is lower, so the density is assumed to be 8.79 lb/gal and the differential pressure is 0.5 atm due to piping. This pump uses 17.78 W of power and costs about \$5,700 per pump (Peters et al., 2003).

Pump P1.04 a,b is the last stainless steel rotary pump. It transports a viscous oil/butane mixture to the flash drum for separation. The pressure differential is 1 atm due to the piping and heat exchanger. The density of this mixture is assumed to be 4.94 lb/gal which gives a power requirement of 31.11 W and a cost of about \$5,700 per pump (Peters et al., 2003).

Pumps P1.06 a,b and P1.07 a,b transport butane to and from the butane holding tank (TK1.01). The flow rate and density (4.78 lb/gal) is the same for both. Peristaltic pumps are used because the flow rate is lower than 1 GPM. Neoprene is a compatible material of construction for pumps handling butane (Mykin, n.d.), so pumps of this material are used. Each pump has a pressure differential of 0.5 atm due to the process piping. Each pump uses 15.28 W of power and is priced at \$1,800 per pump (Lab 1st n.d.).

P1.08 pumps the high concentration lye to be combined with the low concentration lye and sulfuric acid. This is a cast iron rotary pump that accounts for a 0.5 atm pressure differential due to piping. The power required is 6.11 W, and each pump costs \$3,640 (Peters et al., 2003).

P1.09 pumps the low concentration lye to be combined with the high concentration lye and sulfuric acid. This is a cast iron rotary pump that accounts for a 0.5 atm pressure differential due to piping. The power required is 8.78 W, and each pump costs \$3,640 (Peters et al., 2003).

P1.10 pumps 96% sulfuric acid to neutralize the lye waste streams. A peristaltic pump is used because of the low flow rate. This pump has a pressure differential of 0.5 atm due to the process piping. P1.10 requires 0.167 W of power and costs \$1,800 per pump (Lab 1st n.d.).

3.2.5 Heat Exchanger Design

For all heat exchangers the overall heat transfer coefficient is assumed to be 850 W/(m²K). The first heat exchanger, E1.01, is used to heat the lye solution to 30°C from 26.9°C.

The concentration of the lye is very low, so the density and heat capacity are assumed to be that of water. This heat exchanger is sourced from Grainger (n.d.-a) and has 70.3 kW water heat dissipation, a 2.4 ft² area, and can handle 12 GPM. The heat required to raise the temperature of the lye is 4.25 kW. To heat to the desired temperature, 0.23 GPM of heated water at 100°C from the block 3 production fermenter heat exchanger is used and exits at roughly 31°C. The calculations assume a residence time of 30 minutes each batch.

E1.03 heats the butane/oil mixture to 175°C for flash separation. The heat capacity is assumed to be 0.317 kJ/(kg°C). The heat exchanger will be sourced from Grainger and has 674 kW water heat dissipation and a 45.6 ft² area. The power necessary to heat the mixture from 40°C to 175°C is 14265 W. 170 lb/hour of medium pressure steam at 200°C and 15 bar is used, and the steam exits the exchanger as water at 40°C. The calculations assume a residence time of 30 minutes.

The final heat exchanger, E1.04a,b is discussed in the Compressor section, as it was designed as a necessary addition to the compressor in Aspen Plus V14.

3.2.6 Ancillary Equipment Design

Compressor Design

After the butane and oil mixture is adiabatically flashed at 0.4 atm, the butane is gaseous and needs to be cooled. To liquify the butane, the gas must be compressed to 5 atm and then cooled (P1.05a,b & E1.04a,b) to 40°C. The compressor (P1.05 a,b) for this stage in the process is modeled in AspenPlusV14, and the price is estimated at \$40,440 for a two stage air cooled compressor; this price estimate includes the price of the heat exchanger (E1.04 a,b). The two-stage compressor is modeled as polytropic using GPSA method with a fixed discharge

pressure of 5 atm. Aspen assumes an efficiency of 72% for the compressor and the compressor will run for 10 minutes for each batch.

Air cooling is used to cool the butane post-compression. The cooler has a specified output temperature of 40°C and accounts for a pressure drop of 0.5 atm. The power requirement for the compressor is 37 kW with a total cooling duty of 135 kW. The cooler is assumed to be 100% efficient.

Screw Feeders

Screw feeders are used throughout this block to transport solids. All 3 of the screw feeders assume a standard pitch, that the solid is free flowing, and that the screw feeder has a 0° incline.

The first screw feeder is used to transport the sesame seeds from the Air Screen Cleaner to the mixing tank where they will be soaked in lye. The second screw feeder transports the seeds from the centrifuge to the rotary sifter for hulling. Because the flow rate and density of the seeds is the same for the first and second screw feeders, the design requirements will also be the same. The first two screw feeders will have a diameter of 2.75 inches and a screw speed of 24 RPM. The third screw feeder moves the remaining sesame meal to the extraction setup after the seeds are mechanically ground for primary oil extraction. This screw feeder requires a diameter of 2 inches and a screw speed of 27 RPM.

3.2.7 Energy Requirements

The air screen cleaner (X1.01) in this block reportedly uses 8.5 kW of power (Julite, n.d.).

To soak the hull-on sesame seeds in the lye solution, the NaOH and Na₂CO₃ pellets must first be mixed into water to form a 3% Na₂CO₃ & 0.04% NaOH solution (V1.01). The specific heat of this solution was determined using the rule of mixtures and a weighted average of component heat capacities. Assuming the water supply is at ambient temperature (25°C) and atmospheric pressure, the exothermic dissolution can be expected to raise the temperature of the solution to 27°C. The Na₂CO₃ and NaOH will be dissolved in the cooling water in a 215 gallon stainless steel mixing tank with a marine impeller ($N_Q = 0.5$) at a mixing speed of 50 RPM, which is required to maintain particle suspension of the sodium hydroxide pellets. Assuming the solution has a density similar to that of water, the power required for dissolving the solids to make the lye solution is 160 W.

Additional heat must be added to the lye solution to reach a temperature of 30°C and minimize the necessary soaking time without requiring significant energy to heat the lye. The expected energy required to heat the lye to the desired 30°C is roughly 0.35 kW (E1.01). After the lye solution is prepared and heated, it is pumped to an identical 215 gallon stainless steel mixing tank (V1.02) and combined with the hull-on seeds. Because the goal in this mixing tank is solid suspension, a pitch blade turbine with 4 blades at a 45° angle is used as the impeller ($N_Q = 0.87$) with a mixing speed of 73 RPM, resulting in a mixing power requirement of 1.4 kW. The sesame seeds soak in the lye solution for approximately 40 minutes, and the energy required to maintain the temperature at 30°C for the duration of the soak is 13 kW. It is assumed that any losses are due to forced convection, so a heat transfer of 500 W/(m²-K) was used for calculations as a conservative estimate (Engineering ToolBox, n.d.). The energy put into the solution from the impeller is nearly equal to the energy required to maintain the temperature of the lye, so this can be considered thermally neutral and no additional heat is necessary to maintain the temperature.

The water washing of the lye soaked seeds feeds approximately 0.68 GPM of seeds with a density of 10.21 lb/gal (Sesame Oil Product Description, n.d.) and 2.5 GPM of lye solution (density assumed to be that of water). Roughly 100 gal/hr of washing water to achieve equal parts water to seeds. The 300 gallon mixing tank (V1.03) has a pitch blade turbine with 4 blades at a 45° angle ($N_Q = 0.87$) with a mixing speed of 48 RPM, resulting in a power requirement of 5.2 kW. This assumes a velocity to tip speed ratio of 0.95, and a density of 8.76 lb/gal. After the water washing, separation of the seeds is completed using a sedimentation tank.

The heat duty of toasting sesame seeds was found to be 69,300 W based on the heat capacity of the sesame seeds and the evaporation of the water in the seeds. Optimal conditions are toasting the seeds at 180°C for 10 minutes. It is assumed that the sesame seeds fed to the seed toaster are stored at ambient temperature (25°C). Target product outputs require 402 lbs/hr of sesame seeds to be fed to the process. The specific heat capacity of white sesame seeds is 3 kJ/kg-°C at 20% dry basis moisture content (Ashtiana et al., 2014). A 20% moisture content was assumed for the heat capacity because this allows for an average heat capacity of the seeds throughout the heating process. The heat of vaporization of water was assumed to be 2256 kJ/kg. For simplification purposes, the lye existing in the sesame seeds was assumed to evaporate to negligible amounts.

For the grinding step, a sesame grinder from Mini Oil Mills is sourced using 7.5 kW of energy.

The remaining sesame seed meal is contacted with butane for 6 hours at 40°C to produce a second grade sesame oil and the seed cake. The energy required to heat the butane to 40°C is 39 W. Assuming the heat transfer coefficient is 500 W/(m²*K) and that energy losses are a direct result of forced convection, the power required to maintain the butane/oil mixture at 40°C in the

mixing tank for 6 hours is roughly 80 kW. An impeller with high shear strength is ideal for the two immiscible liquids, so a disk turbine will be utilized at 100 RPM. This calculation assumes that the density of the solution is 4.94 lb/gal, resulting in a mixing power requirement of 16 kW.

The desired temperature for extraction of the oil is 40°C for the conservative contact time of 6 hours (Elkhaleefa & Shigidi, 2015). In order for the butane to remain liquid at this temperature, the butane must be pressurized to 5 atm. It is assumed that the butane heat transfer coefficient is 500 W/(m²-K), and any losses are due to forced convection. This extraction is performed batchwise, and double the required volume of butane for extraction is housed within the process, meaning the butane in the butane storage tank is assumed to reach ambient temperature (25°C) while not in use. Two extraction setups are needed, and to produce the desired output 1,550 batches will need to be run per year, which provides plenty of downtime. Fewer batches are used at this stage than at the beginning of block 1. This allows for sufficient contact area and contact time between the butane and sesame seeds to meet production targets.

After 6 hours, the butane and sesame seed meal produce an additional 35% yield of oil. The oil/butane mixture is then fed to a heat exchanger with an output temperature of 175°C. This temperature is below the seed roasting temperature (180°C) and should not alter the flavor of the oil nor denature any proteins. The mixture is then fed into an adiabatic flash drum (X1.05 a,b) at a pressure of 0.4 atm where the desired 500 mg/kg separation is reached. This is a 0 duty flash, so the energy requirement for separation is solely that of the heat exchanger.

The final heat exchanger (E1.04a,b) is a cooler and requires the removal of 135 kW of energy. This cooler was modeled in conjunction with the compressor in Aspen Plus V14; the compressor pressurizes the butane to 5 atm which allows the butane to be liquified at 40°C. Cooling water at 25°C will be used in this shell and tube heat exchanger, which has a contact

area of 45.6 ft^2 . The required flow rate for cooling water is 9.47 GPM, and the cooling water will exit the heat exchanger at 45°C .

The first phase of processing involves the grinding of the defatted cake into a finer flour that can more easily be suspended in a solution. Typical milling sizes achieve a final particle average of 70 micrometers (Pang et al., 2021). Because primary milling has already occurred, and milling is a physical rather than chemical process, the product losses during this step are deemed negligible. The flour will then be combined with water and lactobacillus inoculum to conduct the primary fermentation. Water is mixed with the flour to provide the solution needed for anaerobic digestion.

The anaerobic digester unit (R2.02) represents the greatest chemical change in the sesame cake as it is processed. The defatted sesame meal flour is mixed with lactobacillus cultures and is heated to 37°C. During this period, organic molecules undergo catabolic reactions with a net result of partial conversions of proteins to free amino acids, fibers to oligosaccharides, and sugars to lactic acids. Energy is harnessed in this process to increase the lactobacillus biomass, but this remains minimal compared to the solids mass within the tank. As fermentation progresses, the loss in fiber and sugar are more rapid than that of proteins (Nayak et al., 2022). This results in a relative concentration of protein density and decrease in total solid mass. The time limit of the fermentation is related to a critical concentration of lactic acid. Lactic acid is an acidulant, and too high of a concentration could result in negative consumer taste experiences. The upper limit of acceptable lactic acid concentration in the product is dependent on both the natural chicken concentration of sodium lactate and the separation efficiency of the coagulation phase. A study of lactic acid injections for chicken preservation determined that customer preferences are unaffected up to 1wt% lactic acid (Van de Marel et al., 1989). A secondary study of lactic acid separation from organic solids at low ph resulted in only 15% of lactic acid remaining with the solid components (Kumar et al., 2020). This resulted in a final lactic acid

limit of 6g/L solids leaving the digester. The corresponding fermentation time to achieve this limit is 12 hours of active fermentation (Khalfallah et al., 2022). The decomposition of condensable organic molecules into non-condensable products for this fermentation time is 20% of the total sesame cake mass.

The primary separation exiting the reactor is achieved through acid catalyzed coagulation and centrifugation (X2.02). Due to the high throughput needs of this unit, a continuous centrifuge will be used. Hydrochloric acid (HCl) is used to adjust the pH of the fermentation broth to 2.5. Using the strongest commercial solution (37 wt%) of HCl as an acidifier, a material balance can be used to determine the needs at 23.7 lbs/hr. A major factor resisting this pH change is the natural buffering capacity of proteins, which may adopt formal charges to absorb this additional hydronium concentration (Dipak et al., 1986). These alterations to the structure denature the proteins, which are then stabilized by forming large aggregates. The aggregates can be condensed with the fiber to form a solid. This occurs more rapidly under centrifugation. Additionally, this centrifugation removes the less dense oils and fats which can be skimmed from the top of this setup with a three phase centrifuge decanter. There are sufficient oils and fats to form a separate phase. While fibers and fats can be hydrolyzed under acidic conditions, they are much less reactive than proteins. This allows the acid coagulation to occur at room temperature in short periods of time, preventing the degradation of the fibers and fats. Due to emulsifiers being largely sedimented, skimming of the organic layer is assumed to be a near complete separation. Other outputs include the sedimented proteins and fibers, and an aqueous phase containing most of the lactic acid, partial metabolites, and sugars. The water content of the cake is expected to be 40 wt% (Zheng et al., 2020). This will be reduced with manual compression (X2.03) to a more concentrated 25 wt%. The pore size of this solid network is loose, so the

concentration of smaller solutes can freely diffuse. This leads to the expelled water being useful for lactic acid extraction and combined with the main supernatant.

Following this compression the seed cake must be pH balanced, to reduce the hydronium ion concentration and therefore the chance of perceived sour flavors. This is done using a small addition of a 40 wt% caustic soda solution. The buffering capacity of the protein matrix does provide some pH resistance, and as a result the stream volume is slightly higher than the entrained water alone would suggest. This adjusted protein slurry is the primary ingredient for the formation of the nugget “meat” and is sent to the final mixing block.

The liquid phase of the coagulation process contains oligosaccharides, free sugars, lactic acid, highly soluble proteins, and ammonium and chloride ions. The first step of the lactic acid recovery is removing the large molecules of oligosaccharides and proteins via reverse osmosis using a nanofilter (X2.04). The pores of the filter are too small for the larger molecules to pass through, and the filtrate contains the ions, free sugars and lactic acid. The condensed protein oligosaccharide mix is highly bioavailable, and could be used as a fermentation feedstock if properly pH balanced.

Following the size exclusion membrane, it was determined that liquid-liquid extraction (X2.05 and X2.06) was the best means of recovering lactic acid. This is due largely to the low concentration of lactic acid within the solution (0.5 wt%). Typical means of concentration such as evaporation would be highly energy intensive, and would not be economically feasible. Highly nonpolar solvents reduce the material losses during the extraction, and the overall energy needs of the extraction process are much lower. Additionally the high distribution coefficients of the extraction allow for reduced volumes of solvent to be used with each washing, and this represents a means of concentrating the lactic acid in solution. Before extraction can begin, lactic

acid must be converted fully from its highly polar sodium lactate form to the protonated lactic acid form (Lan et al., 2019). This is achieved through a second pH adjustment to lower the acidity to 1.5. The second pH adjustment results in nearly all lactic acid remaining in its undissociated nonpolar form, and a subsequent increase in extraction efficiency from 45% to 85% (Lan et al., 2019). Fuming sulfuric acid is the cheapest means of altering the pH, but the low value does result in a large mass being added to this stream. The temperature increase from the acid-base interactions does not damage any of the remaining molecules in solution and allows for greater extraction coefficients, so no cooling will be conducted during this process. Extraction is conducted using a 2:1 aqueous organic ratio of 1-octanol, with 10 wt% trioctylamine being used to stabilize the lactic acid. A re-extraction with a weak caustic soda solution can regenerate the organic solution with only minor readjustments needed during operation. This results in the secondary product of this block as a lactic acid solution that can be dried to a final product. An overall material balance of the block can be found in Table 3.3.1.

Table 3.3.1 Sesame Cake Block Material Balance

Component	In (lbs/hr)	Out (lbs/hr)
Water	1614	1628
Sesame Cake*	131.5	
Live Lactobacillus	0.13	
Misc. Protein		45.96
Misc. Fiber		37.39
Misc. Fats		12.00
Misc. Sugar		0.77
Lactic Acid		7.81
Additional Organics		14.00
HCl/ Cl-	8.77	8.36
H2SO4/HSO4-/SO4-2	162.80	159.45
Trioctylamine	7.48E-4	7.48 E-4
1-Octanol	0.448	0.448
NaOH/ Na+	1.85	1.816
CO2		3.05
Total	1919.16	1919.15

*Water within sesame cake mass (3.5lbs/hr) included within water row

3.3.2 Fermenter Design

The anaerobic fermentation (R2.01 and R2.02) is important to improve the digestibility of the sesame cake. To prepare for the anaerobic fermentation, a starter culture of lactobacillus needs to be introduced to the medium. The means of producing the necessary biomass can be achieved using a seed reactor (not shown on BFD). Beet molasses in an anaerobic fed batch

reactor allows for high conversion of substrate into biomass (Figueredo et al., 2020). Based on the requirements of the seed fermenter, a 26 gal fed batch reactor (R2.01) can produce the necessary biomass and have enough left over as a self starter culture if a starting volume of 2.7 gal water and a molasses feed rate of 0.54 gal/hour is used. Seed batches take 10 hours to achieve their full size in agitated anaerobic conditions at 37°C, and can be loaded ahead of a scheduled fermentation. The products entering the main digester (R2.02) are primarily inoculum and water, as the beet substrate is consumed as it is fed.

Fermentation and the subsequent coagulation separation represents the biggest loss is sesame solids and is used as the main means of determining total processing rates. The sesame cake component of the final product corresponds to a mass flow of 1.95×10^6 lb/yr. The mass of this component is the primary bulk solid of the “meat”. To determine the total solids production requirement, this was divided into solid and liquid components for balancing purposes. The water mass was approximated using a soy-based nugget as a reference, resulting in a breakdown of 50 wt% water and 50 wt% solids. The composition of water in the nuggets affects texture and cooking; the desired moisture content of the nuggets before they are fried is 50 wt% (Sun & Carrascal, 2023). Because the water expulsion costs are higher for the yeast extract component, the seed cake slurry leaving this unit operation will be the minimum 25 wt% water (Jones, 2023). To hit the nugget product output target, an average solids mass flow rate of 78 lb/hr is required to supply Block 4 with the needed materials. When solid losses from the coagulation are accounted for, an organic solids mass of 86 lb/hr needs to be produced. Using the output concentration of the fermentation setup, general water demands were determined with a continuous flow of 1300 lb/hr. Anaerobic digesters do not have the same size limits that aerobic systems do, but inoculum and spoilage considerations result in penalties for systems that are too large. The short

timeframes of digestion do incentivize the rapid cycling of a smaller reactor. Due to the short digestion time frame of 12 hours, it is reasonable to assume that the reloading and sterilization processes can be completed for an overall batch time of 24 hours (Alonso, 1998). To balance the concerns of inoculum, space considerations and labor costs, a single 5300 gal reactor (R2.02) can be used to fulfill the cake fermentation requirements. The overall solids output needs require a batch to occur an average of once every 34 hours, and a schedule of three daily fermentations followed by a longer maintenance day can effectively convert this need and account for total plant downtime. The sizing of this reactor is the standard geometry of a 9 foot 8 inch cylinder in both diameter and height and an impeller half the diameter of the tank. Stirring within the reactor is essential to prevent solid settling and ensure mixing of solution. The suspension requirements of a uniform powder can be expressed by using Equation 3.3.1, where D is the tank diameter, n is the impeller rotation speed (rad/s), rho is the densities of either the liquid or particle components, mu is the viscosity of solution, k is a reactor orientation property, and d is the average particle diameter (Nagata, 1975).

Equation 3.3.1

$$\frac{D^2 n \rho_l}{\mu} = k \left(\frac{dn^2}{g} \right)^5 \left(\frac{\rho_l - \rho_s}{\rho_l} \right)^{-6} \left(\frac{d}{D} \right)^{-8}$$

When physical properties are inserted into this function, the stirring needs of the impeller are determined to be trivial (Appendix 3.2.01). Partial mixing can be achieved with an impeller velocity of 0.74 rad/s and an impeller power consumption of 5.5 kW. Power consumption was calculated using the dimensionless constants of Power number and Reynolds number. The low angular speed of the impeller is a tradeoff between power consumption and impeller force, as the impeller speeds required to create a truly well mixed solution are both beyond realistic mixing energies and have tip velocities that would destroy a live bacteria through collisions. The source

data for digestion kinetics was at an unmixed lab scale, so partial mixing should not greatly affect kinetics.

3.3.3 Separations Design

With the central reactions and material balances covered, additional attention now needs to be paid to the separation processes within the block. The fermentation broth undergoes three main separation processes to reach the final product streams. Solids are first condensed using acid coagulation and centrifugation (X2.02). During this phase the remaining lipids are also removed. After this, noncondensable proteins are removed from the raffinate using ultrafiltration (X2.04). Lastly, pH swing extraction (X2.05 and X2.06) is used to separate lactic acid from ionic compounds and sugars. This process results in three product streams of the solid cake, recovered oil stream, and purified lactic acid and two waste streams of acidic solutions with organic molecules.

Centrifugation uses rotational motion to exacerbate differences in component density and increase the settling rate of a solution. While density is the driving force behind this separation, particle size plays a much larger role in determining the settling time and centrifuge demands. As a result of this, individual proteins, despite being denser than the surrounding water, cannot be centrifuged at significant throughput without long operating times and high energy usage. To increase this settling rate, acidic conditions are used to denature the proteins in the fermentation broth. The denaturing process changes the conformation of the proteins, which exposes hydrophobic and thiol surfaces for adhesion to other proteins. Acidification of this broth will be provided by azeotropic concentration of hydrochloric acid solution. The net result of this acidification is the formation of protein flocs between 1-20 micrometers in size. The

centrifugation demands are based on the hardest to separate component, which is the one micrometer protein flocks. Oil globules have a minimum significant particle size of 1.5 micrometers and starch granules have a minimum particle size of 2 micrometers (Fujii, 2017). The density driving forces for separation of these components still render the one micrometer protein flocs the limiting component for the separation. The most common centrifuge type for food processes is a disc stack centrifuge. This type uses a series of angled discs to generate additional separation surfaces for larger volume streams. Some disc stack centrifuges also have multiple supernatant options for liquid-liquid separations. A three phase disc stack centrifuge will be used.

A three phase disc stack centrifuge is a continuous operation while the fermentation that feeds it is a batch process. Because the cost of the fermenter is low compared to a similar sized tank, two redundant main fermenters will be used, with one being drained by the centrifuge (X2.02) while the other is prepared for a fermentation. To minimize startup and shutdown of the centrifuge, the processing rate will be aligned so that the batch processing time is the same as the batch production time. This means that the centrifuge (X2.02) will process 20,000 L/day at full capacity, and can be shut down and recalibrated once every four days. The necessary throughput for this stream can be achieved using a LHC 270 three phase centrifuge from Liaoning Fuyi Machinery Co (n.d.) operating at 6,858 RPM (Appendix 3.2.02). The output flow rates while the centrifuge is in operation are slightly higher than the normalized average. To maintain this continuous operation and reduce the number of storage tanks needed for the plant, downstream components will be sized to this alternate flow rate. The three outputs of the centrifuge are a nonpolar oil stream with a yearly average flow rate of 12 lbs/hr (16.8 lbs/hr actual), an aqueous

stream with a yearly average flow rate of 1331 lbs/hr (1848 lbs/hr actual), and a solids stream with a yearly average flow rate of 104 lbs/hr (146.33 lbs/hr actual).

The next major separation process following the centrifugation is an ultrafiltration of the supernatant (X2.04). This separation is size exclusionary, so particles larger than the pore diameter will remain in the retentate. This allows for the small particles of saccharides, free salts, and lactic acid to be separated from the larger non-condensable proteins. The acidic environment of this separation requires the use of inert polyfluorinated mesh filters, but PTFE filters can be doped to be hydrophilic or hydrophobic, leading to a slight increase in filter cost. A study into ultrafiltration optimization for a lactic acid fermentation broth determined that a filter pore size of 20 kDa resulted in a high degree of separation without a significant pressure drop (Torang et al., 1999). The low amount of protein concentration within the broth also incentivized the usage of a spiral filter to reduce the overall number of modules to complete the filtration process. The filter module V6-1-1812TM from Synder Filtration (2024) can be set up in series to concentrate the proteins. Proteins will be concentrated until 90% of the original water content exits through the pores. Because the final protein concentration is still less than 5wt%, it is assumed that precipitation will not be an issue that cannot be overcome with backwashing. Based on the permeate flow rate per unit filter area, filter area of a module, and centrifuge output rate, 34 modules are required to achieve this separation if no retentate recycling occurs. The maximum filter entry pressure is 8 bar and the minimum exit pressure is 0.7 bar. Redundancy and downtime due to backwashing can be accounted for by having three groups of 17 modules in series. One group will receive backflow while the others process material. This switch off will occur at hourly intervals to keep the level of fouling low. To ensure that the driving force does not decrease due to osmotic pressures, a simple Van't Hoff calculation was used to approximate the

protein concentration that flux would be greatly reduced (Appendix 3.2.03). The approximation does not take into account the molecular size and therefore may be an underapproximation of osmotic pressure.

The last major separation method within the sesame cake block is a pH swing extraction (X2.05 and X2.06). This separates the lactic acid from the remaining small molecules using polarity. Trioctylamine is the major stabilizing agent of the lactic acid partition, with 1-octanol used as a diluent for the organic phase. The major small molecules in solution are oligosaccharides, monosaccharides, lactic acid, other organic acids, and amine chloride and sulfide salts. In the highly acidic environment, organic acids will be protonated and partitioned in the organic phase. Sugars will remain in the aqueous phase. Lastly, the amine chloride and sulfide salts increase the polarity of the aqueous phase and provide a significant salting out driving force to the extraction. This additional driving force allows for the ability to downsize the organic layer compared to the aqueous phase and increase the concentration of lactic acid. The solubilities of both octanol in water and water in octanol are less than 1g/L, so mixing effects were ignored (Lang, 2012). Similarly, because the lactic acid concentrations in both solutions are minimal, the volume component of lactic acid is assumed to be irrelevant and therefore the relative ratio of aqueous to organic phase is maintained. A prediction equation was used to find the number of stages the countercurrent extractor would need to operate (Treybal, 1951), but it was determined that a McCabe-Thiele approach would be easier. Using the extraction coefficient from literature (6.4) as an equilibrium line, and the ratio of aqueous to organic phase as the operating line, it was determined that four stages would be needed to recover 99% of the lactic acid from the aqueous phase (Lan, 2019). Due to the favorable partition coefficients, it was determined that a solvent to extractant ratio of 2:1 could be used to reduce column size and

power demands. Actual liquid-liquid extractions are heavily diffusion limited, so the assumed tray efficiency was 40% for both extraction (X2.05) and re-extraction (X2.06) using a York-Scheibel column. A similar approach was used with the re-extraction column (X2.06), but with a differing extraction coefficient (10.35 from experimental data) and a higher recovery requirement (99.8%) to ensure that lactic acid entrainment was minimized (Lan, 2019). The organic solution after re-extraction has a lactic acid concentration of 2.35×10^{-3} wt%. Due to this low value, the recycled organic solution was assumed to have a lactic acid concentration of 0. This operation uses a basic solution of 6 g/L sodium hydroxide to deprotonate the lactic acid and bring it to its more polarized form. Tray efficiency was used to determine the actual number of trays required, with an actual tray number of 10 for the extractor (X2.05) and 13 for the re-extractor (X2.06). This corresponds to an actual length of 10 and 13 ft, respectively. The flooding parameters were used to determine the flow velocity through the column. A simple flow rate conversion was then used to determine the required diameter for the column (Appendix 3.2.04) (Seader). This resulted in a diameter of 8 inches for the extractor, and 6 inches for the re-extractor. The output after the re-extraction is a sodium lactate solution at 2wt%. An aqueous waste stream is also generated from this separation

Important factors to consider within this product stream are the contaminants within it. Other organic acids have similar properties, so small amounts of citric, acetic, and propanoic acid produced during the fermentation will exist as contaminants. This prevents it from achieving a status of premium biopolymer feedstock. Additional contamination includes small amounts of trioctylamine and octanol. While octanol is deemed safe for human consumption in low quantities by the FDA, trioctylamine is strongly hazardous in aquatic environments and shows moderate bioaccumulation (FDA, 2023). This renders this product stream unlikely to be food

grade, and therefore it will need to be dried and sold as sodium lactate monomer. Sodium lactate will not significantly crystallize in water and therefore a large evaporator unit would be needed to concentrate this stream (Sigma Aldrich, 2024). An evaporator (X2.06) with a duty of 89 kW could provide the necessary energy. Some of this heat could be integrated to reduce energy costs, but this presents a large increase in power expenditure. A reverse osmosis process could also reduce the water content, but this represents a high capital and operating cost to maintain the membranes. Neither process would remove the remaining contaminants from the solution. An additional nonpolar extraction could result in the removal of remaining solvent, but the purification would have issues removing octanol and trioctylamine from the organic solvent after washing.

3.3.4 Grinding Equipment Design

Two major physical operations are present within this block. The first of these is the milling of seed cake (X2.01) to present a finer consistency for fermentation. This is accomplished using a 12 in diameter granite mill from Pleasant Hill Grain Products (n.d.). Each of these devices has a maximum throughput of 190 lbs of grain per hour. Because each batch requires 4500 lbs of seed cake, it is necessary to begin preparing flour several hours before fermentation occurs. A single mill at maximum capacity could narrowly provide the necessary throughput, but redundancy with two devices results in a more realistic operating window for the type of machine. A third spare device allows for additional resilience to account for equipment downtimes and maintain production quotas.

The second primary physical operation is the dewatering of the coagulated solids of centrifugation (X2.03). This is accomplished with a screw press produced by Henen Kelefu

Equipment Technology Co (n.d). This device has an operational range of 100-150 lbs/hr of solids and is constructed of stainless steel. After dewatering, the sesame slurry is reduced from 41wt% to 25wt% water. The water output from this process is mixed with the centrifuge supernatant and the combined stream passes through the lactic acid recovery pipeline.

3.3.5 Tank Sizing

Storage tanks allow for reduced labor costs and waste transit costs, and serve as storage to interface batch and continuous processes. All tanks are simple storage with the exception of the caustic soda tank (Tk 2.07), which requires an impeller to dissolve the sodium hydroxide pellets. Storage tanks for reagents and waste were sized based on the assumption of weekly deliveries of supplies and the capacity to hold a second week of material if needed. The results of these are shown in Table 3.3.2.

Table 3.3.2 Storage Tank Sizing - Block 2

Tank Number	Tank Contents	Tanks Size (gal)
2.02	Fermentation Broth	5,300
2.03	Hydrochloric Acid	850
2.04	Sesame Oil	700
2.05	Protein Slurry Waste	5,000
2.06	Sulfuric Acid	3,700
2.07	Caustic Soda	150
2.08	Acid Aqueous Waste	60,000
2.09	Organic Solution	30

The remaining tanks' sizing was determined through the batch demand that a tank would realistically encounter. Because the centrifugation processing speed is the same as the average fermentation broth volume produced per hour, an equivalent tank size would meet requirements. As a result tank 2.02 is 5,300 gal in volume. For the sesame flour storage, the ideal tank storage would hold the volume required for all three fermentations of the main scheduling cycle. As a

result, tank 2.01 needs to hold 13,500 lbs or 350 cubic feet of flour. Due to the constant cycling of inventory, super sacks are the ideal intermediate storage. This also allows for ease of transportation using forklifts.

3.3.6 Pump Design

Transport of product throughout the unit operations requires the usage of multiple pumps. Pumps were placed in regions with high pressure drops where hydrostatic head could not be used to deliver the required force. This required five main pumping zones. The first of these transports live cells from the seed fermenter to the main fermenter (P2.01). Because the shear of centrifugal pumps can damage live cells, a positive displacement gear pump was used. This pump needs to empty the seed tank in five minutes, and to overcome the pressure drop corresponding to the friction of the pipes and the height differential of the output. The power requirement from these conditions amounted to 12.45 W during operations.

A second pump (P2.02) located on the main tank draws broth into the centrifuge. Due to the low peak flow rate the maximum wattage required is 37 W. The pressure drop for this sector is small and a reinforced slurry centrifugal pump is cheaper than a gear pump. These two pumps comprise the major components of the upstream sector.

For the downstream sector, an area of high pressure drop within the system is the ultrafiltration modules. The fermentation broth post centrifugation is effectively water, so centrifugal pumps are the choice when moderate flow rates are needed for the entire lactic acid recovery sector. The ultrafiltration modules have a maximum operating pressure of 8 bar and an assumed pressure drop per element of 0.85 bar. This means that a single stream will need to be repressurized as it passes through the filter series. This is achieved by a pump on the 9th (not shown on PFD) and 17th stages of each filter line. Because volume is ejected as permeate

throughout this process, the volume demand of the stage 9 pump is larger than the stage 17 pump. As solution passes through the 18th to 34th modules, the pumps at these pressure checkpoints will need to be throttled to prevent filter blowout. The energy demand of the first checkpoint (P2.05) is 264W and the energy demand of the second checkpoint is 210W. Buying identical pumps for the entire UF setup can reduce the number of required pumps in reserve. The last two pumps (P2.03 and P2.04) move basic solutions to the re-extraction column and balance the pH of the fermentation solids. Both require precise flow rates, so metering pumps are used. The moderate flow to the re-extraction column requires a diaphragm pump with a peak power requirement of 6.01 W, while the smaller flowrate of the solids balance uses a peristaltic pump with a negligible power requirement of 1.13 mW.

3.3.7 Energy Requirements

Heating requirements were determined for the inflows to the fermenters, liquid-liquid extraction, and the lactic acid concentration evaporator. Fermentation requires the liquid to be heated from 25°C to 37°C. Heating loads were determined using the heat capacity, mass flows, and temperature shifts required for the unit operation. Heat demand focused on providing initial temperatures rather than maintaining certain temperatures. The seed fermenter (R2.01) requires an energy flow of 2,644 kJ to maintain this metric. The heat capacity used for water was 4.184 kJ/kg and the heat capacity used for molasses was 2.162 kJ/kg (Dodo et al., 2016). A similar setup was used for the main seed cake fermenter (R2.02), with the same heat capacity for water and a value of 1.59 kJ/kg for the heat capacity of the sesame flour (Engineering Toolbox, 2003). It was assumed that the heat capacity of sesame and wheat flour were similar due to a lack of data. This resulted in an energy requirement of 1.059 GJ for the primary fermenter per batch. The liquid-liquid extractions require a temperature of 70°C. Because the organic phase is recycled,

the energy demands of heating this stream were not considered. Using the same heat capacity value for water as earlier it was determined that the overall energy required is 20.8 kW. The mineral acids used for preparation of this step have exothermic enthalpies of mixing, and this was considered as a form of heating the solution. Based on data from *Elementary Principles of Chemical Processes* (Felder, Rousseau, & Bullard, 2016), it was determined that 11.9 of the 20.8 kW required for heating can be provided by mineral acid introduction. This results in a real heating demand of 8.9 kW. The re-extraction aqueous stream also needs to be heated, and was assumed to have the heat capacity of pure water. This stream required heating from 25 to 70°C and an energy demand of 25.5 kW.

For the lactic acid solution evaporator (X2.07), stream 2.19 is raised from 70°C to 100°C and vaporized. The most significant energy cost is the vaporization itself at 2256 kJ/kg (Engineering Toolbox, 2004). The energy demand of this step is 88.8 kW. To reduce the overall cost, steam produced by this evaporator provides the other energy demands of this block.

3.3.8 Heat Exchanger Design

Several reactions such as the fermentation and extractions are temperature specific. Heating is required to prepare the streams for their alterations. This is accomplished through the usage of double pipe heat exchangers. The five major heating concerns for this section of the process are evaporation of water from the final lactic acid product (X2.07), heating of seed fermenter broth from 25 to 37°C (R2.01), heating of the lactic acid solution from 37 to 70°C (E2.01), heating of the re-extraction solution 25 to 70°C (E2.02), and heating of the main fermenter broth from 25 to 37°C (R2.02). The evaporation of the lactic acid solution (X2.07) uses a natural gas heater to evaporate water from the solution. Heat integration from the steam

generated provides 84 kW of condensable steam energy. This steam is used for heating systems within the block. For the seed fermenter (R2.01), it was determined that 4.41kW of condensable steam energy would heat the tank contents in 10 minutes. The means of heating was determined to be a jacketing system with an estimated heat transfer coefficient of $2 \text{ kW} \cdot \text{m}^2/\text{K}$. This was used to find a predicted jacketing area of $.34 \text{ ft}^2$. All steam power is assumed to be explicitly due to steam condensation, and no cooling of steam water afterwards. This was done to maintain a thermal driving force and reduce exchanger size. Heat losses to the environment were also ignored. The heat duty and driving force of the extraction heat exchangers were known and produced a necessary area of 1.08 and 2.80 ft^2 for the aqueous phase entering the extractor and re-extractor, respectively. For the heating of the primary fermenter (R2.02), it was assumed that nearly the entire stock of remaining condensable steam energy (48.5 kW) would be used for heating the tank. This would accomplish the task in 6 hours. While this is a significant heating time, the thermal mass of the tank is high, and this still allows for the batching schedule to continue as planned. The required heat exchange area for this heating would be 3.79 ft^2 , and stirring would be needed to prevent localized heating of the tank.

3.4 Block 3: Yeast Extract Production

3.4.1 Material Balance

Yeast extract, utilized as a flavoring agent in the final nugget product, requires a multi-step production process involving the extraction of internal yeast cell components, shown in Figure 3.4.1. Initially, aerobic fermentation of brewer's yeast is conducted to increase biomass, utilizing two fermenters, R3.01 and R3.02. The process begins with heating molasses, water, and yeast in a shell and tube heat exchanger, E3.01, before feeding them into the first bioreactor. The molasses fed to the process comes from a set storage tanks, TK3.01a-b, and is pumped using a rotary pump, P3.01. Subsequently, water and molasses are heated by a shell and tube heat exchanger, E3.02, mixed in a mixing vessel, V3.01a-d and continuously added to the reactor at a controlled rate via peristaltic pumps, P3.02a-d. Oxygen, crucial for aerobic fermentation, is introduced to both the seed and production fermentation tanks through aeration. The contents of the primary reactor are then transferred to the secondary reactor using a centrifugal pump, P3.04, followed by the addition of a molasses and water mixture through peristaltic pumps, P3.03a-d after being heated by a shell and tube heat exchanger, E3.03, and combined in a mixing vessel, V3.02a-d. Given the substantial biomass necessary to meet production demands, four sets of fermentation equipment are employed.

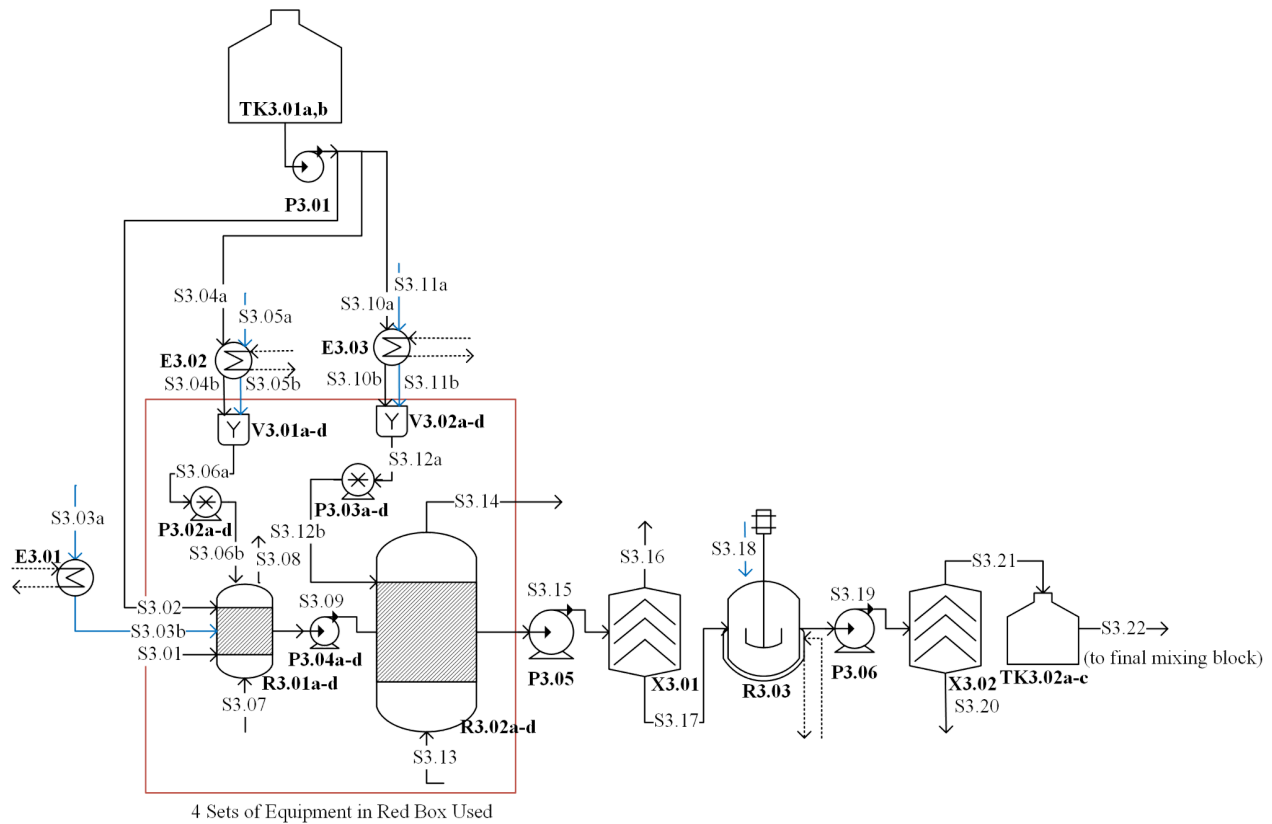

Figure 3.4.1 Process Flow Diagram for Yeast Extract Production.

Following the completion of the second fermentation, the contents of the fermenter are pumped to a disc stack centrifuge, X3.01, via a centrifugal pump, P3.05, to separate the yeast from the fermentation broth, thus reducing the concentration of sugars and other components in the final product. The resulting residue, comprising yeast cells, water, and residual fermentation components like ethanol and minerals, is introduced into the autolysis vessel, R3.03, along with additional water. Upon the conclusion of all four fermentations and the passage of fermenter contents through the disc stack centrifuge, the vessel begins heating to induce autolysis of the yeast cells. This thermal process ruptures the yeast cells, releasing enzymes that degrade the cell wall. Upon completion, the mixture is pumped via P3.06 to another disc stack centrifuge, V3.04,

to remove cell debris. Subsequently, this mixture is transferred to a series of holding vessels, TK3.02a-c, for integration into the final mixing block.

To meet production requirements for the final mixing block, approximately 90,000 pounds of yeast extract must be produced each year. Approximate hourly flow rates for this block are calculated based on the yearly expectations, divided based on 24-hour workdays in which the plant operates for 45 weeks of the year. Inputs and outputs of the yeast extract block are listed in Table 3.4.1. As stated earlier, the primary inputs to the process are yeast, molasses and water. The main outputs of the process are yeast extract, cell debris (solids waste), other components from molasses, and ethanol. A significant amount of carbon dioxide is produced through the fermentation process, being the second largest outlet stream at 63 lbs/hr.

Table 3.4.1 Block 3 Stream Table

Component	In (lbs/hr)	Out (lbs/hr)
Yeast	0.05	
Molasses	113.73	
Water	377.94	404.33
Oxygen	3.59	
Nitrogen	13.5	13.5
Yeast Extract		10.46
Solids Waste		6.79
Carbon Dioxide		63.03
Ethanol		0.26
Other Components		10.27
Total	522.33	522.33

3.4.2 Yeast Extract Fermenter Design

An aerobic fermentation is performed to increase the yeast biomass to achieve production goals. Aerobic fermentation of yeast follows kinetics similar to Michaelis-Menten kinetics. The equation for specific growth rate is listed below in Equation 3.4.1. Using the kinetic parameters from a study on the growth kinetics of *Saccharomyces cerevisiae*, aerobic yeast extract fermentation using sugar cane molasses was modeled (Win et al., 1996). While molasses serves as the carbon source for the growth of yeast cells, too much carbon can lead to excess ethanol production and cell death, so a fed batch reactor was chosen to keep sugar at an optimal level. Sugar cane molasses, which is used as the carbon source for yeast growth, is a byproduct of refined sugar production, and was assumed to be a complete nutrient for aerobic yeast fermentation due to the crude protein it contains (Mukhtar et al., 2010). Sugar cane molasses contains approximately 62% reducing sugars, 23% water, 9% other minerals and components, and 6% crude protein (Palmonari et al., 2020). Due to the relatively high sugar content, the feed molasses must be diluted to prevent growth inhibition. The optimal feed concentration was determined to be 1.6 lb sugar-gal⁻¹, which is approximately 30 wt% or 22 vol% molasses and the balance water.

Equation 3.4.1. Equation and Parameters for Specific Growth Rate of Yeast

$$\mu = \frac{\mu_{max}S}{K_s + S + \frac{S^2}{K_i}}$$

To model the fermentation of yeast, the system of ODEs in Equation 3.4.2 was used to optimize yield, reactor volume, and oxygen transfer. Equation 3.4.2a represents the cell mass growth, based on the specific growth rate. Equation 3.4.2b represents the sugar mass, with the first term serving as the consumption based on the yeast mass, the second term is the amount added based on the feed rate, and the third term is the consumption of sugar required by the yeast

for survival. Equation 3.4.2c represents the volume based on the feed rate, which is calculated from Equation 3.4.3. The feed rate is based on the requirements of the yeast, which grows as more yeast is made to ensure the sugar concentration is optimal to prevent cell death or excess ethanol growth. Equation 3.4.2d is the oxygen concentration, which is based on the mass transfer rate through the fermentation media and the consumption of oxygen by the cells. It was assumed that the oxygen uptake rate included both the consumption of oxygen for growth and survival of the yeast. Through the fermentation process, a small amount of ethanol was produced. Based on results from Win et al. (1996), ethanol production was calculated based on a final concentration of 0.6 g/L. Carbon dioxide was also produced in the fermentation process, and was assumed to be the remaining balance of mass unaccounted for.

Equation 3.4.2a-d. System of ODEs to Model Yeast growth

$$\begin{aligned}
 \text{a) } & \frac{dx}{dt} = x\mu \\
 \text{b) } & \frac{dR_s}{dt} = -Y_{s/x}x\mu + C_{S,F}F - xC_{R_s/x} \\
 \text{c) } & \frac{dV}{dt} = F \\
 \text{d) } & \frac{dC_{O_2}}{dt} = k_l a(C^* - C_{O_2}) - \frac{xY_{O_2/S}}{V}
 \end{aligned}$$

Equation 3.4.3. Feed Rate

$$F = \frac{\mu x V Y_{s/x}}{C_{S,F}}$$

The equations were solved using MatLab, and fermenter conditions were optimized based on the results obtained. Optimization of the reactor conditions involved altering the fermentation time, initial concentrations of yeast and sugar, and the concentration of the feed molasses stream to obtain the most efficient results. Due to the near exponential growth rate of yeast, biomass

must be first grown in a seed reactor, which is then fed to a larger reactor to perform the main biomass growth. Feed conditions of the seed reactor (R3.01a-d) were determined based on the lowest starting mass of yeast cells to produce 44 lbs of yeast in a reasonable timeframe and maintain a yeast concentration around 0.3 lb-gal⁻¹. This required a starting mass of 0.88 lbs of yeast, 1.8 lbs of molasses, and 26 gallons of water. 44 lbs of cell mass was reached after 31 hours of fermentation and final seed reactor volume was 130 gal, which contains 44 lbs of yeast at a concentration of 0.34 lb-gal⁻¹ and a final sugar concentration of 0.1 lb-gal⁻¹. Yeast cell mass, sugar concentration, and reactor volume for the seed fermenter are shown in Figure 3.4.2. The seed fermenter also produced 130 lbs of carbon dioxide in addition to 0.64 lbs of ethanol.

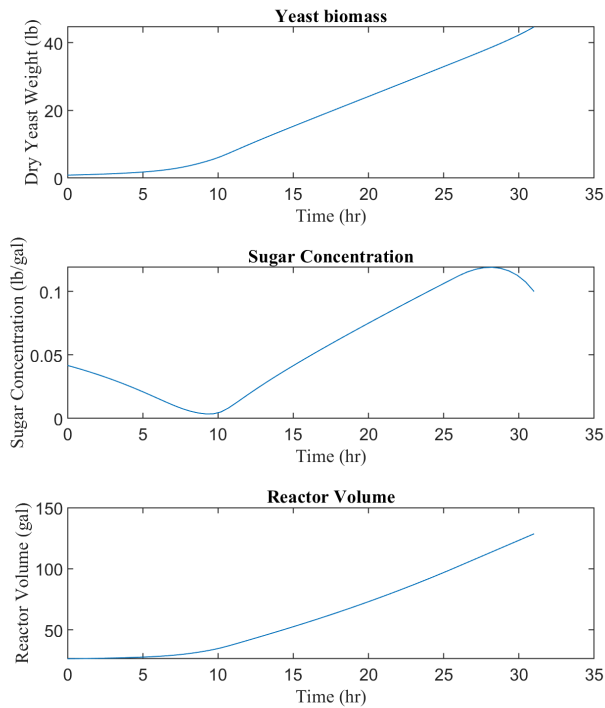

Figure 3.4.2. Seed fermenter (R3.01a-d) yeast mass, sugar concentration, and volume over time

The goal of the production fermenter (R3.02a-d) was to create the most amount of biomass in less than 35 hours and the least amount of leftover sugars with the conditions leaving

the first reactor. This was achieved by running the reactor for a total of 33 hours after reducing the molasses feed at 26 hours to a flow rate that would both reduce the sugar content and increase the cell concentration. At the end of the production fermentation, the sugar concentration was near 0 and yeast mass reached 340 lbs at a concentration of 0.39 lb-gal⁻¹. The addition of adequate molasses resulted in a final reactor volume of 870 gal. Yeast cell mass, sugar concentration, and reactor volume for the production fermenter are shown in Figure 3.4.3. The production fermenter also produced 1,100 lbs of carbon dioxide and 5 lbs of ethanol per cycle.

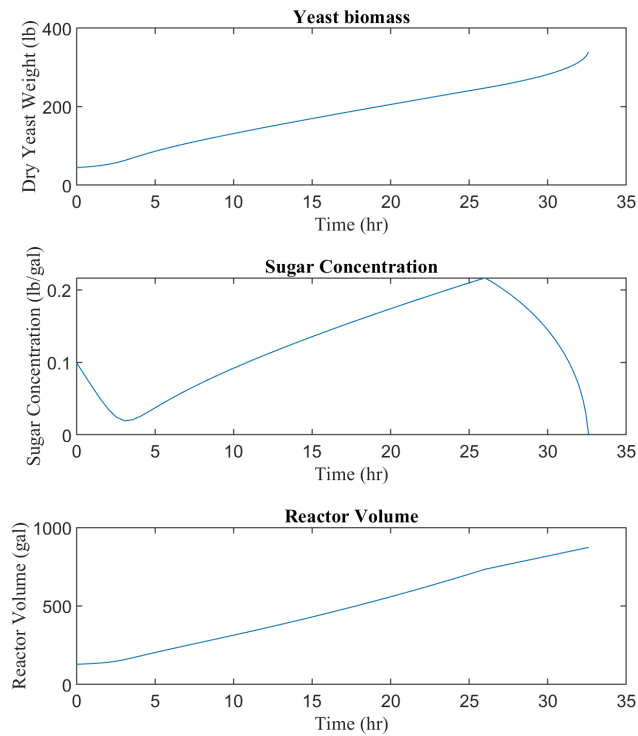

Figure 3.4.3. Production fermenter (R3.02a-d) biomass, sugar concentration and volume for fermentation

The seed fermentation (R3.01a-d) requires a 132 gal bioreactor based on feed requirements. The diameter of the bioreactor is 2.82 ft with an area of 6.25 ft², and standard geometry was assumed. A rushton impeller was selected for mixing to improve oxygen transfer;

impeller diameter was found to be 0.942 ft, assuming impeller diameter is equivalent to $\frac{1}{3}$ of the tank diameter, and only one impeller is required. The bioreactor temperature is 30°C and air is used as the aeration source, with 21% oxygen. Density and dynamic viscosity of the growth media were calculated based on weight percentage of molasses because it is more viscous than water. The Arrhenius rule for liquid mixtures was used to calculate the viscosity of the mixture (Appendix 3.4.01). A sample calculation for the density of the feed mixture can be found in Appendix 3.4.02. The density of this mixture is 8.45 lb/gal and viscosity is 0.00059 lb/ft-s.

The oxygen uptake rate was found to be $0.0136 \frac{g O_2}{g X - h}$ (Kuriyama & Kobayashi, 2003) and C^* was found to be 5.788E-5 lb/gal assuming the broth contains the maximum dissolved oxygen from water (Chemical Features of Water, 1987). A target $k_L a$ was calculated using a target yeast output concentration of 0.347 lb/gal and maximum oxygen uptake rate (Appendix 3.4.03). Typical aeration rates for yeast extract fermentation are 0.5-1.0 vvm (Misailidis & Petrides, 2020), and typical impeller speed for this size bioreactor ranges from 50-300 RPM (Prpich, 2023). Impeller speed and aeration rate were varied to optimize the bioreactor based on the total power requirement and to achieve a $k_L a$ within 10% of the design target determined above. An impeller speed of 125 RPM and aeration rate of 0.2 vvm were found to meet these parameters; the $k_L a$ at these conditions is $98.9 h^{-1}$, total power requirement is 16.5 W, and energy required per volume is $33.0 W/m^3$ (Appendix 3.4.04). Energy loss due to exposure to ambient temperature and water evaporation can be assumed to be counteracted by the energy input from mixing.

Based on the molasses and water feed requirements for the seed fermenter (R3.01a-d), a mixing tank (V3.01a-d) with a total volume of approximately 100 gal is required. The dimensions of the tank were determined to be 2.2 ft in height and 2.8 ft in diameter, based on a

height to diameter ratio of 0.8, which is preferred in mixing tanks (Dynamix Agitators, 2015). Assuming a marine impeller with diameter $\frac{1}{3}$ that of the tank, the required power for this mixing was determined to be 45 W, based on an impeller speed of 125 RPM (Caframo Lab Solutions, 2016). See Appendix 3.4.05 for detailed calculations.

A similar approach was used to design the production fermenter (R3.02a-d). A 925 gal bioreactor is needed to achieve target yeast extract production rates. Standard geometry was assumed for this case; bioreactor diameter is 5.4 ft and area of the tank is 22.89 ft². One rushton impeller is needed with a diameter of 1.80 ft. The fermentation is run at 30°C and aerated with air. The viscosity of the feed mixture is 8.23 lb/gal and the density is 0.00099 lb/ft-s. Oxygen uptake rate and C^* are $0.0136 \frac{g O_2}{g X-h}$ and 5.788E-5 lb/gal, respectively. The target cell output is 0.389 lb/gal, resulting in a target $k_L a$ of 107.5 h⁻¹. Typical impeller speeds for a bioreactor of this size range from 50-250 RPM (Prpich, 2023). An impeller speed of 125 RPM and aeration rate of 0.7 vvm were found to meet these requirements. The design $k_L a$ is 103.8 h⁻¹, total power required is 1454.3 W, and energy required per volume is 415.5 W/m³.

Similar to the seed fermenter, a mixing tank for the continuous feed of molasses and water is required. Based on the feed requirements, a mixing tank (V3.02) volume of approximately 750 gal is required. The dimensions of the tank were determined to be 4.3 ft in height and 5.4 ft in diameter, based on a height to diameter ratio of 0.8, which is preferred in mixing tanks (Dynamix Agitators, 2015). Assuming a marine impeller with diameter $\frac{1}{3}$ that of the tank, the required power for this mixing was determined to be 1,000 W, based on an impeller speed of 125 RPM (Caframo Lab Solutions, 2016). Energy loss due to exposure to ambient temperature and water evaporation can be assumed to be negligible with the energy input from mixing.

The design specification requires 150,000 lbs of whole yeast to be produced in a year, or 2,900 lbs/week based on yields of downstream process equipment. With the specified fermenter dimensions, this will require 20 pairs of seed and production fermentations to run every 2 weeks. Because each takes less than 35 hours, 4 sets of 132 gal seed fermenters (R3.01a-d) and 925 gal production fermenters (R3.02a-d) will be run at a schedule such that they are each run 5 times in 2 weeks for a total of 20 batches every 2 weeks (Figure 3.4.4). Because this is above the average amount of yeast required every 2 weeks, the yeast extract fermentation block only needs to run for approximately 45 weeks out of the year.

Running at this schedule will require the final yeast extract product to be stored in a holding tank before it is used in the final block. Assuming that approximately 2,400 lbs of yeast extract in water are removed each day and the yeast extract has a 1 week break every 4 weeks with an additional week break 6 months in, a maximum capacity of 6,700 gal is required. To ensure the vessels can be properly sanitized, 3 smaller vessels (TK3.02a-c), each with a 2,500 gal capacity from Supplyline Industrial will be utilized.

Additionally, molasses must be stored on-site storage for the fermentations. To maintain a smooth operational flow, an estimated two weeks' worth of supply, roughly totaling 4,000 gal, must be readily available. To meet this demand, two 2,100-gal tanks (TK3.01a,b) from Supplyline Industrial will be deployed such that cleaning of these tanks can be accomplished on a regular basis. These tanks have been chosen for their capacity to withstand the high density of molasses, hence opting for smaller HDPE tanks.

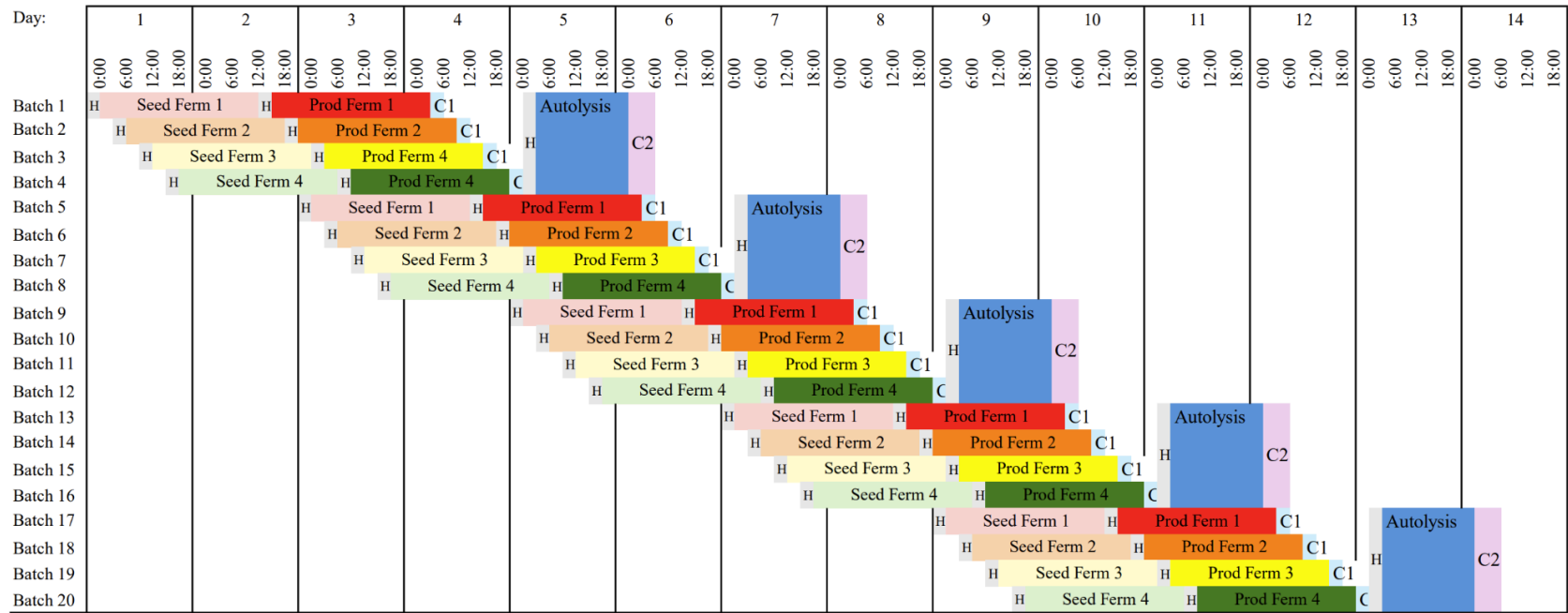

Figure 3.4.4. 2-week example production schedule for yeast extract. H indicates a heating cycle, C1 and C2 represent the yeast and yeast extract disc stack centrifuges respectively.

3.4.3 Autolysis Design

Autolysis, which occurs in R3.03, utilizes heat to prompt cell rupture and enzyme release, facilitating the breakdown of yeast cell walls to release their internal components. The important factors influencing yeast extract yield post-autolysis include temperature, duration, and cell concentration. According to a study by Tanguler and Erten (2008), optimal conditions for solids extraction entail a temperature of 45°C maintained for 16 hours, with a cell concentration of 150 g/L. These conditions were fine-tuned to minimize time and energy consumption while maximizing solids yield. Although prolonged autolysis periods exhibited heightened protein yield, the marginal increase post-16 hours didn't justify the associated costs (Tanguler & Erten, 2008). The final yield of solid yeast extract at 16 hours, based on the initial whole cell mass, was determined to be 60% post-centrifugation and drying (Tanguler & Erten, 2008). Hence, it was assumed that 60% of the cell mass entering the autolysis vessel (R3.03) converted into yeast extract, while the remaining 40% constituted cell debris, subsequently removed during centrifugation.

To prepare the slurry containing cells from the previous centrifugation step (X3.01), it was assumed that it comprises 50 wt% water, totaling 2,650 lbs from 4 fermentation batches. To achieve a cell concentration of 1.25 lbs/gal, approximately 785 gal of water need to be added. After the final volume reaches 1,100 gal, heating from an ambient room temperature of 25°C to 45°C while ensuring continuous mixing is required to begin the autolysis process.

For optimal mixing, a cylindrical vessel with a height to diameter ratio of 0.8 was selected, coupled with a marine impeller having a diameter $\frac{1}{3}$ that of the vessel (Dynamix Agitators, 2015; Caframo Lab Solutions, 2016). Thus, the tank (R3.03) measures 5 ft in height and 6 ft in diameter, with an impeller diameter of 2 ft. Assuming an impeller speed of 100 RPM,

this results in a power requirement of 1,128 W, assuming the physical properties of the fluid in the vessel are similar to water. A heated mixing tank with a 1,000 gal capacity from Glacier tanks is used to estimate the pricing. To elevate the tank's temperature to 45°C, a tank jacket will be employed, detailed in section 3.4.6.

3.4.4 Separations design

The yeast extract block involves two primary separations. The first separation (X3.01) aims to extract yeast cells from the broth to reduce the concentration of excess mineral components from the molasses. This is achieved using a disc stack centrifuge, chosen over filtration due to the compressible nature of the yeast cake, which would require prolonged filtration times. The design of the centrifuge incorporates considerations for size, number of plates, plate angle, volumetric throughput, and rotation speed. Utilizing Equations 3.4.4-5, along with certain assumptions, facilitated the determination of the rotation speed necessary for effective yeast cell separation (Schweitzer, 1979).

Equation 3.4.4 (Vecchiarello, 2023)

$$V_g = \frac{4r_p^2(\rho_p - \rho_f)g}{18\mu}$$

Equation 3.4.5 (Vecchiarello, 2023)

$$\frac{V_g}{Q} = \frac{2\pi(n-1)}{3g} \omega^2 \cot\theta (R_0^3 - R_i^3)$$

Several assumptions were considered in the analysis: the fermentation broth was assumed to exhibit the same viscosity and density as water; yeast cells were assumed to be spherical with a diameter of 4µm (Artis Micropia, n.d.); and the density of whole cells was assumed to be 9,096

lb/gal (Schimek et al., 2020). It was also assumed that the outlet of each centrifuge was approximately a 50 wt% solids/water slurry. The inlet of the initial centrifuge (X3.01) was a mixture consisting of 92% water, 5% whole yeast cells, and 3% ethanol and excess molasses components. Based on the process throughput requirements, a disc stack centrifuge with an outer diameter of 230 mm and a maximum drum speed of 6,930 RPM was selected (Nanjing Fivemen Machine, n.d.). Due to a lack of detail on the manufacturer's website, assumptions were made regarding the centrifuge's inner radius ($\frac{1}{3}$ of the outer radius), the number of discs (50), and a disc angle of 47° , drawing from information in *Perry's Handbook* (Green & Southard, 2019). To calculate the final drum speed, the particle velocity, V_g , was calculated using Equation 3.4.4, which was used to calculate the centrifuge speed, θ , in Equation 3.4.5. The required drum speed was calculated considering moderate throughput, minimal time requirements, and low power consumption. This resulted in a throughput of 18 GPM and a drum speed of 3,200 RPM, ensuring each batch from the fermenters can be separated in under 50 minutes. Based on the throughput of 18 GPM, the energy requirements of this centrifuge are 3,870 W (Dolphin Centrifuge, 2023).

The second separation (X3.02) involves removing cell debris from the yeast extract using a disc stack centrifuge, with parameters determined using Equation 3.4.4-5, similar to the calculation of the yeast cell separation. The yeast extract was assumed to have the viscosity and density of water, while the cell debris was assumed to have a particle size $\frac{1}{16}$ that of a yeast cell and a density of 10,849 lb/gal (Schimek et al., 2020). The inlet of this centrifuge (X3.02) was a mixture consisting of 85% water, 9% yeast extract, 6% cell debris, and a small amount of excess fermentation components. The selected disc stack centrifuge, with an outer diameter of 270 mm (Nanjing Fivemen Machine, n.d.), was analyzed using similar assumptions as in the previous

calculation, considering 50 plates, a 47° plate angle, and an inner radius $\frac{1}{3}$ of the outer radius (Green & Southard, 2019). Incorporating considerations for time and energy requirements, the calculated drum speed is 5,178 RPM, yielding a throughput of 4.4 GPM and just over 4 hours of separation time for a single autolysis batch, or 4 fermentation batches. Based on the throughput of 4.4 GPM, the energy requirements of this centrifuge are 968 W (Dolphin Centrifuge, 2023).

3.4.5 Pump Design

The yeast extract block contains numerous pumps that require design specifications, all of which were designed using stainless steel for food safety. The first pump (P3.01) required is to move molasses from the holding tank into the process. To transfer molasses, a robust pump is needed due to the high viscosity of molasses, which can reach 5,000 times that of water (Smooth-On, n.d.). Considering this, a rotary pump was chosen. It can pump molasses at a maximum flow rate of 7 GPM with an efficiency of approximately 90% (Moore, 2009). Accounting for frictional losses resulting from piping and heat transfer equipment, each contributing a pressure drop of 0.5 atm, a total pressure drop of 1 atmosphere is required. Consequently, the maximum power required is 58 W.

The next pumps (P3.02a-d & P3.03a-d) facilitate the transfer of the molasses and water mixture into the fermenters. Given the variable flow into the fermenters over time, the pump design was optimized based on the maximum flow rate. Peristaltic pumps were selected for their versatility in accommodating varying flow rates, particularly suited for this application where the flow rate into the fermentation vessel remains relatively low. It was assumed that the peristaltic pumps operate with an efficiency of 90%. Frictional losses in the pipes were accounted for, resulting in a pressure drop of 0.5 atm for both pumps. With maximum flow rates of 0.07 GPM

for the seed fermenter pump (P3.02a-d) and 0.5 GPM for the production fermenter pump (P3.03a-d), the corresponding maximum power requirements were calculated to be 0.32 W and 1.8 W, respectively. Because the wattage is small compared to other operations, the power consumption by these pumps will be assumed to be negligible.

The following pump (P3.04a-d) in the process transfers the contents from the seed fermenter to the production fermenter. With the objective of completing this transfer within a 15-minute timeframe, a rotary pump was selected for its efficiency and ability to handle whole cells. Meeting these specifications, a flow rate of 8.2 GPM was determined to be necessary. Additionally, accounting for a pressure drop of 0.5 atm due to frictional losses in the pipes and an efficiency of 90%, the power requirement for this operation was calculated to be 29 W (Moore, 2009).

The subsequent pump in the process (P3.05) transfers the fermentation tank (R3.02a-d) contents to the initial centrifuge (X3.01). According to the centrifuge design calculations in section 4.4.4, a flow rate of 17 GPM is necessary. Utilizing a rotary pump for this purpose, with an efficiency of 90%, and considering a pressure drop of 0.5 atm due to frictional losses in the pipes, the power requirement for this pump was determined to be 61 W (Moore, 2009). Its operation duration is set at 45 minutes each cycle.

The final pump in this block (P3.06) serves to transfer the contents of the autolysis vessel into the second disc stack centrifuge. Aligning with the centrifuge's design specifications, a flow rate of 4.4 GPM is required. A centrifugal pump with 30% efficiency is selected, and the pressure drop remains at 0.5 atm, due to frictional losses in the piping system (Peters et al., 2003). The power requirement for this pump is calculated at 46 W, with an operational duration of 4 hours and 10 minutes per cycle.

3.4.6 Heat Exchange Design

In the yeast extract production process, there are a total of four heat exchangers, three of which are dedicated to heating the materials for the fermenters. The first heat exchanger (E3.01) plays a crucial role in heating the water initially entering the seed fermenter. Although yeast and molasses are also introduced at this stage, their quantities are small enough that heating the water sufficiently ensures the entire mixture reaches the required temperature. To heat the water, a shell and tube heat exchanger is employed, with the water flowing through the tubes and utility heating water circulating through the shell side. To prevent process delays, it was assumed that the entire mass of water, weighing 220 lbs, could be heated within a 10-minute timeframe. To reduce energy consumption, 100°C water from Block 2 will be utilized.

Designing the shell and tube heat exchanger involved calculating the heat duty required to raise the fluid temperature, utilizing Equation 3.4.6a. Because both components are water, an assumed overall heat transfer coefficient, U , of 850 W/m²-K was applied. Given the relatively small quantity of water to be heated, a small heat exchanger listed on Grainger's website served as a reference for determining the required heat transfer area (Grainger, n.d.-a). The smallest available heat exchanger has a surface area of 2.4 ft², which was utilized to compute the exit temperature of the exchanger. Using equations b and c in Equation 3.4.6, the exit temperature of the exchanger was determined to be 27°C, with a calculated heat duty of 3,480 W. Finally, Equation 3.4.06d was employed to calculate the flow rate of the hot water based on the determined heat and temperature change, resulting in a flow rate of 0.2 GPM.

Equation 3.4.06

$$a) Q = mC_p \Delta T$$

$$b) Q = UA\Delta T_m$$

$$c) \Delta T_m = \frac{T_{hot,in} - T_{cold,out} - (T_{hot,out} - T_{cold,in})}{\ln\left(\frac{T_{hot,in} - T_{cold,out}}{T_{hot,out} - T_{cold,in}}\right)}$$

$$d) m_{hot\ water} = \frac{Q}{C_p \Delta T}$$

The heat exchanger for the continuous feed stream into the seed fermenter (E3.02) was designed following a similar approach. A shell and tube heat exchanger was employed, with the seed fermenter feed utilizing the same size heat exchanger as the initial feed heat exchanger. To ensure reasonable heating timeframes, it was assumed that heating the water, weighing 650 lbs, would take 20 minutes, while heating the molasses, weighing 250 lbs, would take less than 10 minutes. To reduce energy consumption, 100°C water from block 2 will be used. This resulted in calculated heat duties of 5,200 W and 3,000 W for the water and molasses, respectively. Using this information, the outlet temperatures were determined to be 32°C and 26°C for the water and molasses, respectively. Consequently, the required utility hot water flow rates were calculated to be 0.3 GPM.

Equation 3.4.7 Steam Flow Rate Calculation

$$m_{steam} = \frac{Q}{H_{vap}}$$

The heat exchanger for the continuous feed of the production fermenter (E3.03) was calculated similarly to the previous two exchangers with some slight alterations. Due to the larger volume of materials requiring heating, there is not an adequate amount of hot water from block 2, necessitating the use of steam utility. Utilizing a stainless steel heat exchanger with a surface area of 2.4 ft² (Grainger, n.d.-b), the calculation of steam required for heating the feed involved a process similar to previous heat exchangers, with some adjustments. Since steam is the medium, heat transfer occurs primarily through condensation, and it was assumed the

temperature of the steam remained constant. Consequently, the time required to heat the water and molasses was varied to determine the steam flow rate. Additionally, the overall heat transfer coefficient for this system was $2000 \text{ W/m}^2\text{-K}$ and the steam flow rate was derived based on the heat of vaporization, assumed to be 2256 kJ/kg , rather than temperature difference and heat capacity (Equation 3.4.7). This adjustment resulted in approximately 20 minutes of heating for the 4,800 lbs of water and 10 minutes for the 1,950 lbs of molasses. With these parameters, the heat duty for water and molasses was determined to be $32,000 \text{ W}$ and $16,000 \text{ W}$ respectively, corresponding to a steam flow rate of 113 lbs/hr for the water and 56 lbs/hr for the molasses.

The final heat exchanger in the yeast extract block is the heating jacket on the autolysis vessel (R3.03). A jacket was chosen due to its simplicity of implementation, and also because some of the yeast mixture needs to remain stationary for extended periods, which could result in heat loss if it were circulated through a traditional shell and tube heat exchanger. The yeast mixture was assumed to have similar physical and thermal properties as water. To heat the yeast mixture, steam was utilized. Calculations were similar to the previous heat exchanger, with calculating the duty based on the heat requirements over a period of time utilizing Equation 3.4.5a. To ensure adequate heat transfer time, 4 hours of heating time was allocated to the autolysis vessel, which resulted in a maximum heat duty of $24,000 \text{ W}$. Using this, the heat transfer area was calculated using Equations 3.4.5b and c, and was determined to be approximately 2 ft^2 , assuming the tank is well mixed. Utilizing Equation 3.4.6, the required flow rate of steam was determined to be 84 lbs/hr . The heat loss of the vessel to the ambient air temperature was calculated to be $1,240 \text{ W}$, based on an overall heat transfer coefficient of $7 \text{ W/m}^2\text{-K}$ and the surface area of the tank exposed to air. The energy required for mixing,

determined in section 3.4.3, was 1,130 W, resulting in a total of 110 W of heat loss, so the net heat loss was assumed to be negligible.

3.5 Block 4: Final Mixing

3.5.1 Material Balance

The required feeds of stabilizing, thickening, and flavoring agents were determined based on smaller batch recipes for plant-based chicken nuggets and ideal moisture content of the dough before frying. A process overview can be seen in Figure 3.5.1. Sun and Carrascal (2023) determined that the water content of plant-based meats before frying should be 50 wt%. The design targets for the final product, on a weight percent basis, were 65% sesame protein cake, 14% breading, 10% batter, 5% hydrogenated oil, 3% yeast extract, 2% seasoning, and 1% methylcellulose. The sesame protein cake and yeast extract are produced in blocks 2 and 3, respectively; all other ingredients are purchased in bulk. These parameters were used to calculate required feeds, but could not be exactly matched. Prior approximations of final product composition did not include frying oil uptake or ideal water content of the plant based meat before frying. The above recipe is for nuggets made with a soy-based feedstock, which may have slightly different properties than the sesame seeds used in this process. Target production of the plant-based nuggets was determined to be 3MM lbs/yr, approximately 1% of the current plant-based chicken market share.

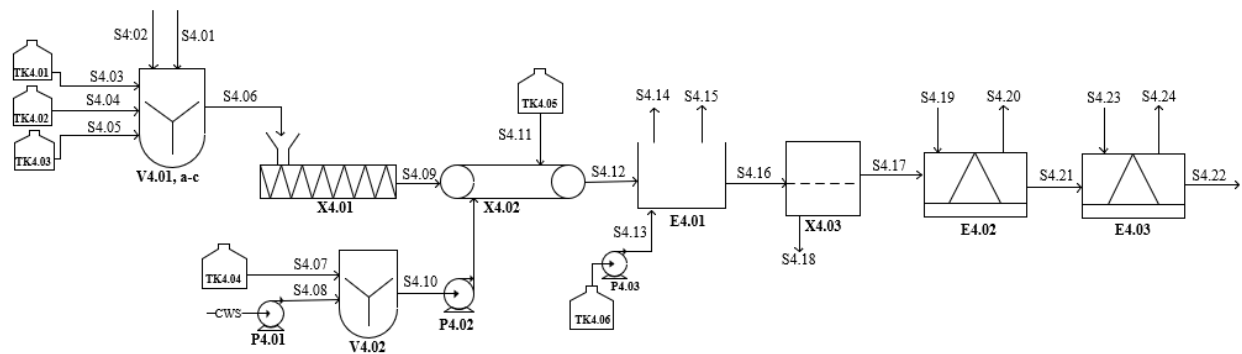

Figure 3.5.1 Process Flow Diagram for Final Mixing

Deep fat frying (E4.01) will be used to cook the final product at a temperature of 180°C for 3 minutes. These conditions were chosen to minimize oil uptake rate while maintaining textural quality (Bhuiyan & Ngadi, 2023). The oil uptake rate during frying was found to be 41.991 lb/hr, and can be used to approximate moisture loss from frying (Appendix 3.5.01). Make-up frying oil is continuously added to maintain the necessary volume of oil in the fryer. A continuous fryer will be used followed by a deoiling machine to remove excess oil and uncooked breading. It was assumed that minimal weight losses would occur during this stage, and that any losses would be from the frying oil and breading. The entire volume of frying oil must also be replaced every 4 days to preserve the flavor and texture quality of the nuggets (Weisshaar, 2014; GoFoodService, 2024). An additional 10,857 gal of canola oil will be needed per year to completely replace the oil in the fryer on this schedule.

Cooling water is used for both the cooling tunnel (E4.02) and blast freeze tunnel (E4.03). The required flow of cooling water through the cooling tunnel is 37.3 gal/hr, and the required flow through the blast freeze tunnel is 28.6 gal/hr. These values were determined using the energy demands for the equipment to cool the nuggets to the desired temperature.

The final product composition on a weight percent basis achieved at these conditions is 41.0% water, 10.5% sesame protein, 0.3% lactic acid, 10.2% miscellaneous solids, 0.05% HCl, 2.8% yeast extract, 4.6% hydrogenated oil, 0.4% methylcellulose, 1.8% seasoning, 8.1% breading, 8.1% batter, and 12.0% canola oil. A simplified stream table can be found in Table 3.5.1. The output of the overall process is 371.5 lbs/hr of plant-based chicken nuggets.

Table 3.5.1 Block 4 Stream Table

Component	In (lbs/hr)	Out (lbs/hr)
Water	193.512	193.512
Sesame Protein	39.070	39.070
Miscellaneous solids (fats, sugars, fiber)	38.247	38.247
Canola Oil	45.000	45.000
Breading	30.000	30.000
Batter	30.000	30.000
Hydrogenated Oil	17.125	17.125
Yeast Extract	10.250	10.250
Hydrogen chloride	0.168	0.168
Seasoning	6.850	6.850
Methylcellulose	1.604	1.604
Lactic Acid	1.250	1.250
Total	413.071	413.071

3.5.2 Equipment Design

Formation of the final plant-based meat nuggets requires mixing of the dough, extrusion, battering, breading, frying, and cooling, as outlined in Figure 3.5.1. The sesame protein slurry and yeast extract are combined with methylcellulose, a seasoning mix, and hydrogenated vegetable oil to form the plant-based meat dough. A spiral dough mixer (V4.01) with a 228 qt. capacity is used to meet production requirements. Three mixers will be required to maintain production timelines while allowing time for mixing and cleaning. No additional water needs to be added to the dough mix because the volume of water in the sesame protein and yeast extract

slurries is sufficient to achieve 50 wt% water in the dough before extrusion. Another mixing tank is required for the batter mix (V4.02). The dry batter requires a 1:2.5 batter mix to water volume ratio, and a 30 gal mixer is needed to meet production requirements. A 6 in. marine propeller is used to achieve a well-mixed batter. Two of these mixers are needed to allow sufficient time for cleaning between batches.

Twin screw extruders are standard in the plant-based meat industry because they create a desirable texture and do not denature proteins (ThermoFisher, n.d.). The chosen extruder (X4.01) from Made-in-China (n.d.-a) has a capacity of up to 1,100 lbs/hr. To account for weight losses during frying and de-oiling, each nugget is formed to weigh 1.56 oz; after cooking and processing, the nuggets weigh approximately 1.4 oz each. The barrel temperature of the extruder is assumed to reach 150°C (Schmid et al., 2022). The nuggets pass through a combined battering and breading machine (X4.02) in which they are dipped into the liquid batter mix on a mesh belt, then coated with the breading before the frying process. The chosen equipment from Made-in-China (n.d.-b) has a belt speed of up to 49 ft/min and a maximum throughput of 1323 lb/hr.

A continuous deep-fryer (E4.01) is used to cook the nuggets. This equipment can be purchased from Made-in-China (n.d.-c) with an oil capacity of 220 gal. and heating time of 25-45 minutes. The oil temperature in the fryer is maintained at 180°C, and the nuggets are cooked for 3 minutes to reduce frying losses and maintain the quality of flavor and texture of the final product. Make-up canola oil must be fed to the deep fryer because of oil uptake during the frying process. It is assumed that frying oil uptake is equal to water loss from frying; the oil uptake rate was calculated as 41 lbs/hr. The selected fryer has an oil capacity of 220 gal. However, to achieve a theoretical oil turnover rate around 20 h, the maximum volume of oil that

will be added to the fryer is 119 gal. Lower oil turnover rates reduce oil degradation during frying and improve the shelf life of the final product. Standard oil turnover rates for industrial fryers range from 5 to 10 hours, but these could not be achieved based on the desired production rate of nuggets (Dunford, 2012).

A continuous de-oiling machine (X4.03) removes excess oil and solids from the nuggets before they are cooled. It was assumed that this process would have minimal effects on the weight of the final product. The chosen unit is a linear vibrating screen from Made-in-China (n.d.-d), which is common in the food manufacturing industry. The nuggets are then cooled to room temperature in a continuous cooling tunnel (E4.02) using cooling water. This equipment can be purchased from Made-in-China (n.d.-e) with a belt length of up to 328 ft and width up to 10 ft. They are flash frozen in a blast freeze tunnel (E4.03) to preserve them during the packaging and shipping processes. A freeze tunnel from Alibaba (n.d.-c) was chosen with a capacity of up to 2,205 lb/hr. Cooling water is used for both cooling units. The packaging of the nugget product from this plant is 53 ft³ double wall Gaylord boxes. A third-party site will be used for packaging the nuggets for consumers.

Storage tanks (T4.01-06) are required for all feeds to this block with sufficient capacity for 2 weeks of raw material storage. It is assumed that deliveries of raw materials will come every 2 weeks. Detailed descriptions of each storage tank are listed in Table 4.4.1.

3.5.3 Pump Design

A peristaltic pump (P4.01) feeds water at ambient temperature (25°C) to the batter mixer (V4.02). Frictional losses from piping is 0.5 atm. The outlet pressure was assumed to be 1 atm,

and the inlet pressure was assumed to be 2 atm to account for frictional losses. The required water feed to the batter mix is 75 lbs/hr. Pump efficiency was assumed to be 70%, resulting in a 2.06 W power requirement. Another peristaltic pump (P4.02) is used to transport the batter mixture to the battering machine. This type of pump was chosen because the mixture is more viscous than pure water and is not compatible with the mechanisms of a centrifugal pump. The density of the mixture was calculated using the densities of water and flour and the mass fraction of each component in the stream; total density was found to be 7.0 lb/gal. The mass flow rate of the batter is 105 lbs/hr, and it was assumed that the pressure drop across the pump would be 1.5 atm; frictional losses from piping was 0.5 atm. The power required for this pump was determined to be 3.43 W.

A third peristaltic pump (P4.03) is needed to feed make-up canola oil to the deep fryer. Frictional losses from piping is 0.5 atm, and the pressure drop across the pump was determined to be 1.5 atm. To maintain the oil level in the fryer, 45 lbs/hr must be fed; the density of canola oil is 7.6 lb/gal (Engineering Toolbox, 2004c). Pump efficiency was assumed to be 70%, and the power requirement was determined to be 1.35 W.

3.5.4 Energy Requirements

The primary energy demands for the final mixing block are around the extruder (X4.01), deep fryer (E4.01), and cooling equipment (E4.02-3). The optimal extruder barrel temperature for plant-based meats is 150°C (Wang et al., 2022) because this maintains the flavor quality of the product. It is assumed that the dough fed to the extruder is at ambient temperature, 25°C. The specific heat capacity of the plant-based meat at 25°C and 70% water content was found to be

3.291 kJ/kg-K using Equation 3.5.1. (Hogg & Rauh, 2023). Dough is fed to the extruder at a rate of 233 lbs/hr. The heat load of the extruder was determined to be 12,101 W.

The total frying heat load includes heat requirements to heat the makeup oil, heat load to fry the nuggets, and energy from boiling water out of the nuggets. Canola oil temperature in the fryer is 180°C to optimize product quality and moisture loss during frying. The makeup oil stream is fed at ambient temperature (25°C) and must be heated to the fryer operating temperature. To maintain oil levels in the deep fryer, 45 lbs/hr of makeup canola oil is fed, so the total mass of oil in the fryer is 811 lbs. The specific heat of canola oil at 180°C is 2.64 kJ/kg-K (Fasina & Colley, 2007). Energy requirements to heat this quantity of oil to the desired temperature is 41,829 W. During extrusion, the chicken nuggets are heated to 150°C (Wang et al., 2022). The nuggets are heated to 180°C during frying, and 376 lbs/hr are fed to the deep fryer. Specific heat capacity of the nuggets is 3.790 kJ/kg-K; this was approximated with Equation 3.5.1., determined by Hogg and Rauh (2023), at 150°C and 70% d.b. moisture content. Required energy to fry the nuggets at these conditions is 5,392 W. 41 lbs/hr of water is lost from the nuggets during the frying process due to evaporation. It was assumed that the initial temperature of the water would be equivalent to the temperature of the nuggets after extrusion (150°C). The specific heat capacity of water is 4.18 kJ/kg-K (Engineering Toolbox, 2004), so the energy required to heat water to the frying temperature is 634 W. The total heat load around the deep fryer is 47,747 W. The selected deep fryer (Made-in-China, n.d.-c) is powered using natural gas and uses stainless steel electric heating tubes to heat the frying oil.

Equation 3.5.1

$$c_p = 3191.03 + 3.9956T$$

The temperature of the plant-based chicken nuggets entering the cooling stage (E4.02) is assumed to be slightly lower than the frying oil temperature after being de-oiled, around 175°C. Desired cooled temperature of the nuggets is 25°C before they are sent to packaging. 372 lbs/hr of the chicken nugget product is entering the cooling tunnel. The specific heat capacity of the nuggets is approximately 3.838 kJ/kg-K, determined by Equation 3.5.1 (Hogg & Rauh, 2023). The moisture content of the plant-based nuggets after frying is 66% d.b.. In these conditions, the heat load to cool the nuggets is -27,004 W.

A blast tunnel freezer (E4.03) is used to flash freeze the final product before it is packaged. The chosen equipment operates at -60°C (Alibaba, n.d.). It is assumed that the nuggets will be frozen to this temperature after being cooled to 25°C. The freeze point of the nuggets was assumed to be that of water (0°C) because water is the largest component (on a mass basis) of the nuggets. The specific heat capacity of the nuggets is 3.176 kJ/kg-K at 25°C and 3.066 kJ/kg-K at 0°C, found using Equation 3.5.2. Due to insufficient published data, the latent heat of fusion of the vegan nuggets was best approximated with the heat of fusion of real chicken, 220 kJ/kg (ASHRAE, 2006). To freeze 372 lbs/hr of the nuggets, -22,671 W of energy are required.

Equation 3.5.2

$$c_p = 3065.70 + 4.4126T$$

SECTION 4: FINAL DESIGN RECOMMENDATION

4.1 Sesame Oil Extraction Final Design

4.1.1 Final Product Specifications

There are three major outputs of block 1, the first and second grade sesame oils and the seed cake. The first grade oil produced is a result of milling the hulled sesame seeds, and it contains no contaminants making it food-grade oil. The first grade oil is considered a cold pressed, unrefined oil. The second grade oil is extracted with butane, and subsequently contains trace amounts of butane. More specifically, the standard for butane contamination in food grade oil is 500 mg/kg which is achieved through flash separation, meaning this secondary oil contains less than 0.05 wt% butane and is food grade. These additional production steps make the second grade oil a refined oil. The seed cake produced also contains trace amounts of butane, yet this is under the minimum 500 mg/kg food-grade threshold. The seed cake contains 2.5 wt% water and less than 0.05 wt% butane.

4.1.2 Equipment

Table 4.1.1 Block 1 Equipment Table

Equipment Type	Equipment ID	Design Specification	Purpose
AirScreen Cleaner	X1.01	Throughput: 424 lb/h	Remove impurities from imported hull-on sesame seeds
Mixer	V1.01	Volume: 210 gal Impeller Type: Propeller Impeller Diam: 0.98 ft	Dissolves Na ₂ CO ₃ & NaOH to create lye solution
	V1.02	Volume: 211 gal Op. Temp: 30°C Impeller Type: Pitch Blade Turbine Impeller Diam: 0.98 ft	Immerses hull-on sesame seeds in lye solution for solid suspension
	V1.03	Volume: 300 gal Op. Temp: 30°C Impeller Type: Pitch Blade Turbine Impeller Diam: 1.3 ft	Immerses hull-on sesame seeds in water solution for solid suspension and removal of lye
	V1.04a,b	Volume: 300 gal Op. Temp: 40°C Impeller Type: Disk turbine Impeller Diam: 1.3 ft	Provides contact opportunity sesame meal and butane for sesame oil extraction
Sedimentation Tank	X1.02	Flow: 4.8 GPM 6.6 ft x 4.9 ft x 8.2 ft	Isolate sesame seeds from lye solution and washing water
Rotary Sieve	X1.03	Throughput: 420 lb/h	Hull removal
Toaster	E1.02	Throughput: 327 lb/h Temperature: 180°C	Maximize flavor & oil yield
Seed Press	X1.04	Throughput: 311 lb/h	Initial oil extraction
Flash Drum	X1.05a,b	Volume: 268 gal/h Temperature: 175°C Pressure: 0.4 atm	Adiabatic pressure flash to separate butane and secondary oil
	X1.06a,b	Volume: 262 gal/h Temperature: 40°C	Ensure that butane is a liquid prior to pumping to the

Cooler	E1.04a,b	Pressure: 5 atm	holding tank
		Flow: 262 gal/h Temperature: 40°C Shell and Tube Area: 45.6 ft ²	Liquify & cool butane after flash separation
Holding Tank	TK1.01	Volume: 3,000 gal	Store excess butane while not in use
	TK1.02	Volume: 5,000 gal Material: HDPE	Store 1 st grade sesame oil
	TK1.03	Volume: 15,000 gal	Store 2 nd grade sesame oil
	TK1.04	Volume: 5,000 gal Material: HDPE	Store 96% sulfuric acid
	TK1.05	Volume: 6,000 gal Material: UV Resin	Collect/Store neutralized wastewater for testing
Compressor	P1.05a,b	Flow: 919 GPM Pressure: 5 atm	Compresses butane gas to 5 atm as part of the butane liquefaction process
Pumps	P1.01	Rotary Pump Power: 18.22 W	Pump lye solution to mixing tank used for immersion of seeds in lye
	P1.02	Rotary Pump Power: 5.2 W	Pump lye/seed slurry into mixing tank to wash seeds with water
	P1.03	Rotary Pump Power: 11.11 W	Pump diluted lye/seed slurry into centrifuge for separation
	P1.04a,b	Rotary Pump Power: 31.11 W	Pump oil/butane mixture to flash drum for separation
	P1.06a,b	Peristaltic Pump Flow: 4.4 GPM	Pump liquified butane to holding tank
	P1.07a,b	Peristaltic Pump Flow: 4.4 GPM	Pump butane from holding tank to mixer for oil extraction
	P1.08	Rotary Pump Power: 6.11 W	Pump lye solution to be combined with other lye stream and neutralized with sulfuric acid

	P1.09	Rotary Pump Power: 8.78 W	Pump lye solution to be combined with other lye stream and neutralized with sulfuric acid
	P1.10	Peristaltic Pump Flow: 4.4 GPM	Pump sulfuric acid to combine with and neutralize lye waste streams
Heat Exchangers	E1.01	Shell and Tube Area: 2.4 ft ²	Heat lye solution to 30°C
	E1.03a,b	Shell and Tube Area: 45.6 ft ²	Heat oil/butane mixture for flash separation

4.1.2 Stream Table

Refer to Figure 3.2.1 for the process flow diagram of this block.

Table 4.1.2 Stream Table for Block 1 (Continued on next page)

Stream		S1.01	S1.02	S1.03	S1.04	S1.05	S1.06	S1.07	S1.08	S1.09	S1.10	S1.11	S1.12	S1.13	S1.14	
Total Flow Rate	lb/hr	424	4	420	1,298	1,717	840	2,557	1,852	705	155	550	331	103	228	
	lb/yr	3,711,612	37,142	4,485,388	11,365,847	15,851,308	7,353,679	23,207,956	16,223,174	6,983,110	1,361,548	5,625,193	3,707,500	899,098	1,999,908	
Components	Sesame Seeds	lb/hr	331	—	327	—	327	—	327	—	327	—	327	327	—	—
	lb/yr	2,903,064	—	3,676,840	—	3,676,840	—	3,676,840	—	3,676,840	—	3,676,840	3,676,840	—	—	
	Hulls	lb/hr	92	—	92	—	92	—	92	—	92	92	—	—	—	—
		lb/yr	808,548	—	808,548	—	808,548	—	808,548	—	808,548	808,548	—	—	—	—
	Impurities	lb/hr	—	4	—	—	—	—	—	—	—	—	—	—	—	—
		lb/yr	—	37,142	—	—	—	—	—	—	—	—	—	—	—	—
	Water	lb/hr	—	—	—	1,259	1,259	840	2,099	1,819	280	62	218	3.5	—	3.5
		lb/yr	—	—	—	11,030,519	11,030,592	7,353,679	18,387,240	15,931,812	2,452,800	543,120	1,913,359	30,660	—	30,660
	Na ₂ CO ₃	lb/hr	—	—	—	38	38	—	38	33	5	1.1	4	—	—	—
		lb/yr	—	—	—	330,916	330,916	—	330,916	286,950	44,178	9,716	34,462	—	—	—
	NaOH	lb/hr	—	—	—	0.5	0.5	—	0.5	0.4	0.07	0.01	0.05	—	—	—
		lb/yr	—	—	—	4,412	4,412	—	4,412	4,412	744	164	532	—	—	—
	Sesame Oil	lb/hr	—	—	—	—	—	—	—	—	—	—	—	—	103	—
		lb/yr	—	—	—	—	—	—	—	—	—	—	—	—	899,098	—
	Sesame Meal	lb/hr	—	—	—	—	—	—	—	—	—	—	—	—	—	225
		lb/yr	—	—	—	—	—	—	—	—	—	—	—	—	—	1,969,248
	Sesame Cake	lb/hr	—	—	—	—	—	—	—	—	—	—	—	—	—	—
		lb/yr	—	—	—	—	—	—	—	—	—	—	—	—	—	—
	Butane	lb/hr	—	—	—	—	—	—	—	—	—	—	—	—	—	—
		lb/yr	—	—	—	—	—	—	—	—	—	—	—	—	—	—
H ₂ SO ₄ (96%)	lb/hr	—	—	—	—	—	—	—	—	—	—	—	—	—	—	
	lb/yr	—	—	—	—	—	—	—	—	—	—	—	—	—	—	

Table 4.1.2 Stream Table for Block 1 (Continued)

Stream	S1.15	S1.16	S1.17	S1.18	S1.19	S1.20	S1.21	S1.22	S1.23	S1.24	S1.25	S1.26	S1.27	S1.28	
Total Flow Rate	135	1,323	73	1,250	0	1,250	0	44	2,180	2,180	38	1	1,259	219	
	lb/hr														
	lb/yr	1,182,600	11,591,232	638,604	10,952,628	0	10,952,643	1,000	383,688	19,105,560	19,105,560	331,128	4,380	11,030,519	1,917,693
Components	Sesame Seeds	—	—	—	—	—	—	—	—	—	—	—	—	—	
	lb/hr														
	lb/yr														
	Hulls	—	—	—	—	—	—	—	—	—	—	—	—	—	
	lb/hr														
	lb/yr														
	Impurities	—	—	—	—	—	—	—	—	—	—	—	—	—	
	lb/hr														
	lb/yr														
	Water	3.5	—	—	—	—	—	—	—	2,180	2,180	—	—	1,259	215
	lb/hr														
	lb/yr	30,660	—	—	—	—	—	—	—	19,105,560	19,105,560	—	—	11,030,519	1,882,699
	Na2CO3	—	—	—	—	—	—	—	—	—	—	38	—	—	3.9
	lb/hr														
	lb/yr											331,128	—	—	34,461.8
	NaOH	—	—	—	—	—	—	—	—	—	—	—	0.5	—	0.0
	lb/hr														
	lb/yr												4,380	—	532.3
	Sesame Oil	—	73	73	—	—	—	—	—	—	—	—	—	—	—
	lb/hr														
lb/yr		638,604	638,604	—	—	—	—	—	—	—	—	—	—	—	
Sesame Meal	—	—	—	—	—	—	—	—	—	—	—	—	—	—	
lb/hr															
lb/yr															
Sesame Cake	131.5	—	—	—	—	—	—	—	—	—	—	—	—	—	
lb/hr															
lb/yr	1,151,940	—	—	—	—	—	—	—	—	—	—	—	—	—	
Butane	—	1,250	—	1,250	—	1,250	0.1	—	—	—	—	—	—	—	
lb/hr															
lb/yr		10,952,628	—	10,952,628	—	10,952,643	1,000	—	—	—	—	—	—	—	
H2SO4 (96%)	—	—	—	—	—	—	—	44	—	—	—	—	—	—	
lb/hr															
lb/yr								383,688	—	—	—	—	—	—	

4.1.3 Energy Demand

The electrical energy demand for each piece of equipment is listed below in table 4.1.02, based on operating time for each piece of equipment over the span of a year. As noted previously, the peristaltic pumps (P1.05a,b; P1.06a,b; P1.07a,b; & P10) are not included in the energy demand calculated due to negligible power requirements. To allow for cleaning and routine maintenance, 2 weeks of downtime are allowed for major equipment in this block; otherwise, equipment is operated 24/7.

Table 4.1.3 Block 1 Energy Requirements

Equipment Type	Equipment ID	Power Requirement (W)	Hours of operation (h/yr)	Energy Requirement (kWh/yr)
Mixers	V1.01	160	2,190	340
	V1.02	690	5,840	4,030
	V1.03	5,832	8,400	51,087
	V1.04 a,b	16,000	6,200	99,200
AirScreen Cleaner	X1.01	14,000	8,400	117,600
Sedimentation Tank	X1.02	550	8,400	4,620
Oil Mill	X1.03	3,000	8,400	25,200
Rotary Sifter	X1.04	55,000	8,400	462,000
Toaster	E1.02	69,300	8,400	582,120
Compressor	P1.05 a,b	37,000	258 ¹	9,558
Pumps	P1.01	18.2	1,460	26.6
	P1.02	10.6	1,460	15.5
	P1.03	17.8	8,400	150
	P1.04 a,b	31.1	258 ¹	8.04
	P1.08	6.11	1,460	8.92
	P1.09	8.78	1,460	12.8
Total				1,355,977

¹Total operation time based on 10-minute runs per batch

4.2 Sesame Cake Fermentation Final Design

4.2.1 Final Product Specifications

The two major outputs of this block are the fermented sesame solids and a high concentration lactic acid solution. The solids contain 37.2% protein, 35.6% fiber, 25.6% water, 1% lactic acid, .3% sugars, and .2% salts by weight. An average of 105 lbs of sesame seed solids are produced per hour. The majority of macronutrients within the solids are sesame derived. The sodium lactate solution is 56.2% lactic acid, 25% water, 16.7% sodium hydroxide, 1.3% other organic acids, and .8% octanol by weight. Trace amounts of TOA present within this stream render it less than food grade, so the primary application will be industrial.

4.2.2 Equipment

Table 4.2.1 Block 2 Equipment Table

Equipment Type	Equipment ID	Design Specification	Purpose
Grinder	X2.01	Throughput: 110 lb/h	Decreases size of sesame seed particles
Fermenters	R2.01	Volume: 26.4 gal Height: 1.65 ft Diameter: 1.65ft Impeller: Rushton Diameter: 6.6 inches	Creates biomass for introduction into primary reactor
	R2.02	Volume: 5,280 gal Height: 9.6 ft Diameter: 9.6 ft Impeller: Rushton Diameter 3.2 feet	Digests sesame meal into a more nutritionally dense form
3 Phase Centrifuge	X2.02	Flow: 180 GPM Inner Disk: 0.82 feet Outer Disk: 1.97 feet	Separates oil, condensable solids and aqueous phases
Spiral Tube Ultrafiltration Setup	X2.04	Area: 3.1 ft ² Material: Polyethersulfone	Provides size based separation processing (LA purification)
Liquid Extraction Column	X2.05	Volume: 26 Gallons Height: 10 Feet Diameter: 8 Inches	Removes Lactic acid from aqueous stream
	X2.06	Volume: 19 gal Height: 13 Feet Diameter: 6 Inches	Removes Lactic acid from organic stream
Evaporator Unit	X2.07	Power: 88.8 kW Energy Source: Gas	Provides boiling point based separation processing (LA purification)
Holding Tanks	TK2.01	3000 lb SuperSack	Stores Sesame Meal
	TK2.02	Volume: 850 gal	Stores Hydrochloric Acid
	TK2.03	Volume: 700 gal	Stores Oil waste
	TK2.04	Volume: 5000 gal	Stores Protein Waste
	TK2.05	Volume: 3700 gal	Stores Sulfuric Acid

	TK2.07	Volume: 60000 gal	Stores Aqueous Waste
	TK2.08	Volume: 30 gal	Stores Organic Solvent
Mixing Tanks	TK2.06	Volume: 150 gal	Mixes NaOH and water for pH balances
Pumps	P2.01	Type: Rotary Power: 12.46 watts	Moves seed reactor contents to primary reactor
	P2.03	Type: Centrifugal Power: 40 watts	Feeds centrifuge with fermentation broth
	P2.04	Type: Peristaltic Power: 1.13 milliwatts	Provides pH adjustment for solids
	P2.05	Type: Centrifugal Power: 327 watts	Provides pressure for UF setup and feeds extraction column
	P2.06	Type: Diaphragm Power: 6.01 watts	Feeds re-extraction column with aqueous phase
	Infilter Pump	Type: Centrifugal Power: 411 watts	Provides pressure for UF setup
Heat Exchanger	E2.01	Type: Shell and Tube Area: 1.08 ft ²	Provides thermal contact for extraction heating
	E2.02	Type: Shell and Tube Area: 2.80 ft ²	Provides thermal contact for re-extraction heating
	R2.02 Jacket	Type: Reactor Jacket Area: 3.79 ft ²	Provides thermal contact for fermentation broth heating
	R2.01 Jacket	Type: Reactor Jacket Area: 0.344 ft ²	Provides thermal contact for fermentation broth heating

4.2.3 Stream Table

Refer to Figure 3.3.1 for the process flow diagram of this block.

Table 4.2.2 Stream Table for Block 2 (continued on next page)

Stream	Unit	2.01	2.02	2.03a	2.03b	2.04a	2.04b	2.05	2.06	2.07b	2.07a	2.08	2.09	2.10
Stream Total	(lb/hr)	135.00	134.38	5.52	1288.60	1416.73	3.05	23.70	0.20	12.00	104.22	1331.08	105.11	166.12
---	(lb/yr)	1,182,600.00	1,177,168.80	48,355.20	11,288,136.00	12,410,537.28	26,718.00	207,568.20	1,708.20	105,120.00	912,967.20	11,660,260.80	920,789.88	1,455,211.20
Water	(lb/hr)	3.50	2.88	5.39	1,289.20	1,297.50	---	14.93	0.12	---	26.01	1,293.54	26.86	3.32
	(lb/yr)	30,660.00	25,228.80	47,216.40	11,293,392.00	11,366,100.00	---	130,769.28	1,024.92	0.00	227,847.60	11,331,410.40	235,293.60	29,083.20
Sesame Cake	(lb/hr)	131.50	---	---	---	---	---	---	---	---	---	---	---	---
	(lb/yr)	1,151,940.00	---	---	---	---	---	---	---	---	---	---	---	---
Sesame Flour	(lb/hr)	---	131.50	---	---	---	---	---	---	---	---	---	---	---
	(lb/yr)	---	1,151,940.00	---	---	---	---	---	---	---	---	---	---	---
Lactobacillus	(lb/hr)	---	---	0.13	---	---	---	---	---	---	---	---	---	---
	(lb/yr)	---	---	1,138.80	---	---	---	---	---	---	---	---	---	---
Misc Protein	(lb/hr)	---	---	---	---	45.96	---	---	---	---	39.07	6.89	39.07	---
	(lb/yr)	---	---	---	---	402,609.60	---	---	---	---	342,253.20	60,356.40	342,253.20	---
Misc Fiber	(lb/hr)	---	---	---	---	37.39	---	---	---	---	37.39	---	37.39	---
	(lb/yr)	---	---	---	---	327,536.40	---	---	---	---	327,536.40	---	327,536.40	---
Misc Fats	(lb/hr)	---	---	---	---	12.00	---	---	---	12.00	---	---	---	---
	(lb/yr)	---	---	---	---	105,120.00	---	---	---	105,120.00	---	---	---	---
Misc Sugars	(lb/hr)	---	---	---	---	2.07	---	---	---	---	0.33	1.74	0.33	---
	(lb/yr)	---	---	---	---	18,133.20	---	---	---	---	2,890.80	15,242.40	2,890.80	---
Lactic Acid	(lb/hr)	---	---	---	---	7.81	---	---	---	---	1.25	6.56	1.25	---
	(lb/yr)	---	---	---	---	68,415.60	---	---	---	---	10,950.00	57,465.60	10,950.00	---
Additional Organics	(lb/hr)	---	---	---	---	14.00	---	---	---	---	---	14.00	---	---
	(lb/yr)	---	---	---	---	122,640.00	---	---	---	---	---	122,640.00	---	---
HCl/ Cl-	(lb/hr)	---	---	---	---	---	---	8.77	---	---	0.17	8.36	0.17	---
	(lb/yr)	---	---	---	---	---	---	76,798.92	---	---	1,471.68	73,207.32	1,471.68	---
H2SO4/ SO-2	(lb/hr)	---	---	---	---	---	---	---	---	---	---	---	---	162.80
	(lb/yr)	---	---	---	---	---	---	---	---	---	---	---	---	1,426,128.00
Trioctylamine	(lb/hr)	---	---	---	---	---	---	---	---	---	---	---	---	---
	(lb/yr)	---	---	---	---	---	---	---	---	---	---	---	---	---
Octanol	(lb/hr)	---	---	---	---	---	---	---	---	---	---	---	---	---
	(lb/yr)	---	---	---	---	---	---	---	---	---	---	---	---	---
NaOH/Na+	(lb/hr)	---	---	---	---	---	---	---	0.08	---	---	---	0.05	---
	(lb/yr)	---	---	---	---	---	---	---	683.28	---	---	---	394.20	---
CO2	(lb/hr)	---	---	---	---	---	3.05	---	---	---	---	---	---	---
	(lb/yr)	---	---	---	---	---	26,718.00	---	---	---	---	---	---	---
pH Value	---	7	7	7	7	5.9	N/A	-2.2	11	N/A	2.5	2.5	6	1.5

Table 4.2.2 Stream Table for Block 2 (continued)

Stream	Unit	2.11	2.12	2.13	2.14	2.15	2.16	2.17	2.18	2.19	2.20	2.21	2.22
Stream Total	(lb/hr)	114.60	1208.13	1377.49	498.50	1370.46	504.58	498.50	299.57	305.74	0.45	10.59	295.15
---	(lb/yr)	1,003,896.00	10,583,218.80	12,066,812.40	4,366,860.00	12,005,229.60	4,420,136.86	4,366,882.80	2,624,246.58	2,678,307.68	3,932.36	92,768.40	2585514.00
Water	(lb/hr)	108.00	1,185.54	1,195.44	---	1,195.44	---	---	297.80	297.80	---	2.65	295.15
	(lb/yr)	946,080.00	10,385,330.40	10,472,054.40	0.00	10,472,054.40	0.00	0.00	2,608,728.00	2,608,728.00	0.00	23,214.00	---
Sesame Cake	(lb/hr)	---	---	---	---	---	---	---	---	---	---	---	---
	(lb/yr)	---	---	---	---	---	---	---	---	---	---	---	---
Sesame Flour	(lb/hr)	---	---	---	---	---	---	---	---	---	---	---	---
	(lb/yr)	---	---	---	---	---	---	---	---	---	---	---	---
Lactobacillus	(lb/hr)	---	---	---	---	---	---	---	---	---	---	---	---
	(lb/yr)	---	---	---	---	---	---	---	---	---	---	---	---
Misc Protein	(lb/hr)	5.61	1.28	1.28	---	1.28	---	---	---	---	---	---	---
	(lb/yr)	49,143.60	11,212.80	11,212.80	---	11,212.80	---	---	---	---	---	---	---
Misc Fiber	(lb/hr)	---	---	---	---	---	---	---	---	---	---	---	---
	(lb/yr)	---	---	---	---	---	---	---	---	---	---	---	---
Misc Fats	(lb/hr)	---	---	---	---	---	---	---	---	---	---	---	---
	(lb/yr)	---	---	---	---	---	---	---	---	---	---	---	---
Misc Sugars	(lb/hr)	0.44	1.31	1.31	---	---	---	---	---	---	---	---	---
	(lb/yr)	3,810.60	11,475.60	11,475.60	---	---	---	---	---	---	---	---	---
Lactic Acid	(lb/hr)	0.55	6.01	6.01	---	0.06	5.95	0.00	---	5.95	---	5.95	---
	(lb/yr)	4,818.00	52,647.60	52,647.60	---	508.08	52,122.00	26.28	---	52,122.00	---	52,122.00	---
Additional Organics	(lb/hr)	---	14.00	14.00	---	13.87	0.13	---	---	0.13	---	0.13	---
	(lb/yr)	---	122,640.00	122,640.00	---	121,474.92	1,165.08	---	---	1,165.08	---	1,165.08	---
HCl/ Cl-	(lb/hr)	---	---	---	---	---	---	---	---	---	---	---	---
	(lb/yr)	---	---	---	---	---	---	---	---	---	---	---	---
H2SO4/ SO-2	(lb/hr)	---	---	159.45	---	159.45	---	---	---	---	---	---	---
	(lb/yr)	---	---	1,396,782.00	---	1,396,782.00	---	---	---	---	---	---	---
Trioctylamine	(lb/hr)	---	---	---	49.80	0.00	49.80	49.80	---	---	0.00	---	---
	(lb/yr)	---	---	---	436,248.00	8.76	436,248.00	436,248.00	---	---	8.76	---	---
Octanol	(lb/hr)	---	---	---	448.70	0.36	448.70	448.70	---	0.09	0.45	0.09	---
	(lb/yr)	---	---	---	3,930,612.00	3,144.84	3,930,612.00	3,930,612.00	---	779.64	3,924.48	779.64	---
NaOH/Na+	(lb/hr)	---	---	---	---	---	---	---	1.77	1.77	---	1.77	---
	(lb/yr)	---	---	---	---	---	---	---	15,522.72	15,522.72	0.00	15,522.72	---
CO2	(lb/hr)	---	---	---	---	---	---	---	---	---	---	---	---
	(lb/yr)	---	---	---	---	---	---	---	---	---	---	---	---
pH Value	---	2.5	---	1.5	---	1.5	---	---	---	---	---	---	---

4.2.4 Energy Demand

The electrical energy demand for each piece of equipment is listed below in table 5.2.03, based on operating time for each piece of equipment over the span of a year. The high variance in pump needs rendered some of the metering pumps irrelevant in terms of overall electricity consumption. Pump 4 is a metering pump that has a peak requirement of slightly more than a milliwatt. In a similar manner, the mixing requirements for the seed fermenter are minimal, and are not considered in the overall electricity cost. A lion's share of the energy usage (83%) is used in slurry processing due to its high viscosity.

Table 4.2.3 Electrical Energy Requirements for Sesame Cake Refinement and Lactic Acid Recovery

Equipment Type	Equipment ID	Power Requirement (W)	Hour of operation (h/yr)	Energy Requirement (kWh/year)
Fermenters	R2.01	Minimal	3,285	Minimal
	R2.02	5,461	4,380	23,919
Centrifuge	X2.02	1,000	6,570	6,570
Screw Press	X2.03	5,500	6,570	36,125
Pumps	P2.01	12.46	22.8	<1
	P2.02	4,300	45.63	196
	P2.03	40	6,570	263
	P2.04	Minimal	6,570	Minimal
	P2.05	327	6,570	2,148
	P2.06	6.01	6,570	39
	Infilter Pump	411	6,570	2,700
Total				71,971

4.3 Yeast Extract Fermentation Final Design

4.3.1 Final Product Specifications

The final output of the yeast extract fermentation block is a yeast extract mixture that contains, by weight, 89% water, 10% yeast extract, and 1% excess molasses components and ethanol. At the current design scale, 915,000 pounds of yeast extract are produced per year which is more than the final product requires, but due to the batch nature of the process, meeting the exact requirements was not possible.

4.3.2 Equipment

All equipment is food grade stainless steel (SS316) unless otherwise specified.

Table 4.3.1 Block 3 Equipment Table

Equipment Type	Equipment ID	Design Specification	Purpose
Fermenters	R3.01, a-d	Volume: 132 gal Op. Temp.: 30°C Impeller Type: Rushton Impeller Diam.: 0.9 ft	Inoculate biomass for production fermenters
	R3.02, a-d	Volume: 925 gal Op. Temp.: 30°C Impeller Type: Rushton Impeller Diam.: 1.8 ft	Maximize biomass production
Autolysis Vessel	R3.03	Volume: 1,100 gal Op. Temp.: 45°C	Break down yeast cell wall to release yeast extract, autolysis
Centrifuges	X3.01	Throughput: 18 GPM Speed: 3200 RPM Outer Diam.: 0.9 ft	Remove fermentation broth from biomass
	X3.02	Throughput: 4.4 GPM Speed: 5180 RPM Outer Diam.: 0.9 ft	Removes cell debris from yeast extract
Mixers	V3.01, a-d	Volume: 100 gal	Mixes molasses and water for seed

		Impeller Type: Marine Impeller Diam.: 0.9 ft	fermenter feed
	V3.02, a-d	Volume: 750 gal Impeller Type: Marine Impeller Diam.: 1.8 ft	Mixes molasses and water for production fermenter feed
Pumps	P3.01	Rotary Pump Max Power: 82W	Transfers molasses to heat exchangers
	P3.02a-d	Peristaltic Pump Max Flow: 0.07 GPM	Feeds the seed fermenter at varying rates
	P3.03a-d	Peristaltic Pump Max Flow: 0.5 GPM	Feeds the production fermenter at varying rates
	P3.04	Rotary Pump Max Power: 29 W	Transfers contents of the seed fermenter to the production fermenter
	P3.05	Rotary Pump Max Power: 61 W	Transfers the contents of the production fermenter to the first centrifuge (X3.01)
	P3.06	Centrifugal Pump Max Power: 46.3 W	Transfers the contents of the autolysis vessel to the second centrifuge (X3.02)
Heat Exchangers	E3.01	Shell and Tube Area: 2.4 ft ²	Heats the water for the initial input to the seed fermenter
	E3.02	Shell and Tube Area: 2.4 ft ²	Heats the molasses and water mixture for the continuous feed into the seed fermenter
	E3.03	Shell and Tube Area: 2.4 ft ²	Heats the molasses and water mixture for the continuous feed into the seed fermenter
Tanks	TK3.01	Volume: 2,100 gal (x2) Material: HDPE	Molasses storage, two tanks will be utilized
	TK3.02	Volume: 2,500 gal (x3) Material: HDPE	Final yeast extract storage, three tanks will be utilized

4.3.3 Stream Table

Table 4.3.02 Block 3 Stream Table (continued on next page)

Note: S3.22 and S4.02 do not line up exactly. Due to the yeast extract process being a batch process, exact alignment was not possible.

Refer to Figure 3.4.1 for the process flow diagram of this block.

Stream		S3.01	S3.02	S3.03	S3.04	S3.05	S3.06	S3.07	S3.08	S3.09	S3.10	S3.11
Total Flow Rate	(lb/h)	0.05	0.09	11.33	13.71	33.40	47.79	1.04	7.77	52.52	99.93	248.39
	(lb/yr)	397	796	99,208	120,107	298,540	418,647	9,065	67,962	460,150	875,414	2,175,935
Yeast	(lb/h)	0.05	—	—	—	—	—	—	—	2.29	—	—
	(lb/yr)	397	—	—	—	—	—	—	—	20,104	—	—
Molasses	(lb/h)	—	0.09	—	13.71	—	13.71	—	—	—	99.93	—
	(lb/yr)	—	796	—	120,107	—	120,107	—	—	—	875,414	—
Water	(lb/h)	—	—	11.33	—	33.4	34.08	—	0.33	48.29	—	248.39
	(lb/yr)	—	—	99,208	—	298,540	298,540	—	2,854	423,059	—	2,175,935
Oxygen	(lb/h)	—	—	—	—	—	—	0.22	—	—	—	—
	(lb/yr)	—	—	—	—	—	—	1,904	—	—	—	—
Nitrogen	(lb/h)	—	—	—	—	—	—	0.82	0.82	—	—	—
	(lb/yr)	—	—	—	—	—	—	7,161	7,161	—	—	—
Carbon Dioxide	(lb/h)	—	—	—	—	—	—	—	6.62	—	—	—
	(lb/yr)	—	—	—	—	—	—	—	57,947	—	—	—
Sugar	(lb/h)	—	—	—	—	—	—	—	—	0.66	—	—
	(lb/yr)	—	—	—	—	—	—	—	—	5,783	—	—
Ethanol	(lb/h)	—	—	—	—	—	—	—	—	0.03	—	—
	(lb/yr)	—	—	—	—	—	—	—	—	290	—	—
Other Components	(lb/h)	—	—	—	—	—	—	—	—	1.25	—	—
	(lb/yr)	—	—	—	—	—	—	—	—	10,914	—	—
Yeast Extract	(lb/h)	—	—	—	—	—	—	—	—	—	—	—
	(lb/yr)	—	—	—	—	—	—	—	—	—	—	—
Cell Debris	(lb/h)	—	—	—	—	—	—	—	—	—	—	—
	(lb/yr)	—	—	—	—	—	—	—	—	—	—	—

Table 4.3.2 Block 3 Stream Table (continued)

Stream		S3.12	S3.13	S3.14	S3.15	S3.16	S3.17	S3.18	S3.19	S3.20	S3.21	S3.22
Total Flow Rate	(lb/h)	348.32	16.06	71.99	344.92	310.92	33.99	84.15	118.14	13.66	104.47	104.47
	(lb/yr)	3,051,349	140,686	630,686	3,021,498	2,723,673	297,826	737,115	1,034,940	119,705	915,213	915,157
Yeast	(lb/h)	—	—	—	17.43	—	17.43	—	—	—	—	—
	(lb/yr)	—	—	—	152,707	—	152,707	—	—	—	—	—
Molasses	(lb/h)	99.93	—	—	—	—	—	—	—	—	—	—
	(lb/yr)	875,414	—	—	—	—	—	—	—	—	—	—
Water	(lb/h)	248.39	—	3.02	316.96	300.93	16.03	84.15	100.18	6.66	93.52	93.52
	(lb/yr)	2,175,935	—	26,489	2,776,593	2,636,139	140,455	737,115	877,569	58,312	819,235	819,235
Oxygen	(lb/h)	—	3.37	—	—	—	—	—	—	—	—	—
	(lb/yr)	—	29,544	—	—	—	—	—	—	—	—	—
Nitrogen	(lb/h)	—	12.69	12.69	—	—	—	—	—	—	—	—
	(lb/yr)	—	111,142	111,142	—	—	—	—	—	—	—	—
Carbon Dioxide	(lb/h)	—	—	56.28	—	—	—	—	—	—	—	—
	(lb/yr)	—	—	493,055	—	—	—	—	—	—	—	—
Sugar	(lb/h)	—	—	—	—	—	—	—	—	—	—	—
	(lb/yr)	—	—	—	—	—	—	—	—	—	—	—
Ethanol	(lb/h)	—	—	—	0.26	0.24	0.01	—	0.01	0	0.01	0.01
	(lb/yr)	—	—	—	2,257	2,143	114	—	114	8	107	107
Other Components	(lb/h)	—	—	—	10.27	9.75	0.52	—	0.52	0.03	0.48	0.48
	(lb/yr)	—	—	—	89,941	85,391	4,550	—	4,550	302	4,247	4,247
Yeast Extract	(lb/h)	—	—	—	—	—	—	—	10.46	—	10.46	10.46
	(lb/yr)	—	—	—	—	—	—	—	91,624	—	91,624	91,624
Cell Debris	(lb/h)	—	—	—	—	—	—	—	6.97	6.97	—	—
	(lb/yr)	—	—	—	—	—	—	—	61,083	61,083	—	—

4.3.4 Energy Demand

The electrical energy demand for each piece of equipment is listed below in table 5.3.3, based on operating time for each piece of equipment over the span of a year. As noted previously, the peristaltic pumps feeding the fermenters are not included in the energy demand calculated due to negligible power requirements. Additionally, pump P3.01 was used for multiple purposes, so the energy usage for each of these was calculated separately.

Table 4.3.03 Electrical Energy Requirements for Yeast Extract Production

Equipment Type	Equipment ID	Power Requirement (W)	Hour of operation (h/yr)	Energy Requirement (kWh/year)
Fermenters	R3.01, a-d	17 ¹	13,950 ²	237
	R3.02, a-d	1,454 ¹	14,850 ²	21,592
Heating/Mixing Vessel	R3.03	158 ¹	7,200	1,138
Centrifuges	X3.01	3,874	375	1,453
	X3.02	968	469	454
Mixers	V3.01, a-d	45	14,400 ²	648
	V3.02, a-d	1,005	15,300 ²	15,377
Pumps	P3.01			
	P3.01 (seed)	22	75	2
	P3.01 (prod)	82	150	12
	P3.04	29	113	3
	P3.05	61	338	21
	P3.06	46	469	22
Total				40,100

¹ Neglecting the power requirement of heating

² Based on total hours of operation for all pieces of equipment

4.4 Mixing and Product Formation Final Design

4.4.1 Final Product Specifications

The composition of the final product as designed, on a weight percent basis, is as follows:
62% sesame protein cake (including water, sesame protein, fats, fibers, and lactic acid), 8%
breeding, 8% batter, 4.6% hydrogenated oil, 2.8% yeast extract, 1.8% seasoning, 0.4%
methylcellulose, and 12.0% canola oil. At the designed scale, 3.3MM lbs/yr are produced.

4.4.2 Block 4 Equipment

Table 4.4.1 Block 4 Equipment Table

Equipment Type	Equipment ID	Design Specification	Purpose
Mixers	V4.01, a-c	Volume: 57 gal Impeller Type: spiral Impeller Diam.: 0.91 ft*	Combines dough ingredients
	V4.02a,b	Volume: 30 gal Impeller Type: marine Impeller Diam.: 0.5 ft	Combines dry batter mix and water
Extruder	X4.01	Max Throughput: 1,100 lb/hr	Forms nuggets
Batter/Breading Machine	X4.02	Max Throughput: 1,300 lb/hr	Coats nuggets in batter and breading
Fryer	E4.01	Volume: 220 gal	Deep fries nuggets
De-oiler	X4.03	Sieve area: 10.76 ft ²	Removes excess oil and breading from nuggets
Coolers	E4.02	Max belt width: 3.94 ft Max belt length: 328 ft	Cools nuggets out of fryer to ambient temperature
	E4.03	Max throughput: 2205 lb/hr	Flash freezes nuggets to be shipped to packaging
Pumps	P4.01	Peristaltic pump Max power: 2.06 W	Feeds water to batter mixer
	P4.02	Peristaltic pump Max power: 3.43 W	Feeds liquid batter to battering equipment
	P4.03	Peristaltic pump Max power: 1.35 W	Feeds make-up canola oil to deep fryer
Tanks	TK4.01	Volume: 30 gal (x2) Material: HDPE	Methylcellulose storage
	TK4.02	Volume: 528 gal Material: SS 304	Seasoning mix storage
	TK4.03	Volume: 850 gal Material: HDPE	Hydrogenated vegetable oil storage
	TK4.04	Volume: 2351 gal Material: SS 304	Dry batter mix storage

TK4.05	Volume: 2351 gal Material: SS 304	Breeding storage
TK4.06	Volume: 2500 gal Material: HDPE	Canola oil storage

*impeller diameter not provided by supplier, assumed $\frac{1}{3}$ tank diameter

4.4.3 Stream Table

Table 4.4.2 Block 4 Stream Table (continued on next page)

Refer to Figure 3.5.1 for the process flow diagram of this block.

		S4.01	S4.02	S4.03	S4.04	S4.05	S4.06	S4.08	S4.07	S4.09	S4.10	S4.11
total flow rate	(lb/hr)	105.11	102.38	1.60	6.85	17.13	233.08	75.00	30.00	233.08	105.00	30.00
	(lb/yr)	920,790	896,884	14,055	60,006	150,015	2,041,749	657,000	262,800	2,041,749	919,800	262,800
water	(lb/hr)	26.86	91.65	—	—	—	118.51	75.00	—	118.51	75.00	—
	(lb/yr)	235,294	802,872	—	—	—	1,038,165	657,000	—	1,038,165	657,000	—
sesame protein	(lb/hr)	39.07	—	—	—	—	39.07	—	—	39.07	—	—
	(lb/yr)	342,253	—	—	—	—	342,253	—	—	342,253	—	—
lactic acid	(lb/hr)	1.25	—	—	—	—	1.25	—	—	1.25	—	—
	(lb/yr)	10,950	—	—	—	—	10,950	—	—	10,950	—	—
misc. solids	(lb/hr)	37.77	—	—	—	—	37.77	—	—	37.77	—	—
	(lb/yr)	330,821	—	—	—	—	330,821	—	—	330,821	—	—
HCl	(lb/hr)	0.17	—	—	—	—	0.17	—	—	0.17	—	—
	(lb/yr)	1,472	—	—	—	—	1,472	—	—	1,472	—	—
yeast extract	(lb/hr)	—	—	—	—	—	10.25	—	—	10.25	—	—
	(lb/yr)	—	—	—	—	—	89,790	—	—	89,790	—	—
other components	(lb/hr)	—	—	—	—	—	0.47	—	—	0.47	—	—
	(lb/yr)	—	—	—	—	—	4,117	—	—	4,117	—	—
ethanol	(lb/hr)	—	—	—	—	—	0.01	—	—	0.01	—	—
	(lb/yr)	—	—	—	—	—	105	—	—	105	—	—
hydrogenated oil	(lb/hr)	—	—	—	—	17.13	17.13	—	—	17.13	—	—
	(lb/yr)	—	—	—	—	150,015	150,015	—	—	150,015	—	—
methyl cellulose	(lb/hr)	—	—	1.60	—	—	1.60	—	—	1.60	—	—
	(lb/yr)	—	—	14,055	—	—	14,055	—	—	14,055	—	—
seasoning mix	(lb/hr)	—	—	—	6.85	—	6.85	—	—	6.85	—	—
	(lb/yr)	—	—	—	60,006	—	60,006	—	—	60,006	—	—
breadding	(lb/hr)	—	—	—	—	—	—	—	—	—	—	30.00
	(lb/yr)	—	—	—	—	—	—	—	—	—	—	262,800
batter	(lb/hr)	—	—	—	—	—	—	—	30.00	—	30.00	—
	(lb/yr)	—	—	—	—	—	—	—	262,800	—	262,800	—
canola oil	(lb/hr)	—	—	—	—	—	—	—	—	—	—	—
	(lb/yr)	—	—	—	—	—	—	—	—	—	—	—

Table 4.4.2 Block 4 Stream Table (continued)

		S4.12	S4.13	S4.14	S4.15	S4.16	S4.18	S4.17	S4.19	S4.20	S4.21	S4.23	S4.24	S4.22
total flow	(lb/hr)	368.08	45.00	9.50	41.08	372.00	0.47	371.53	310.77	310.77	371.53	237.89	237.89	371.53
rate	(lb/yr)	3,224,349	394,200	83,220	359,837	3,258,712	4,073	3,254,638	2,722,345	2,722,345	3,254,638	2,083,916	2,083,916	3,254,533
water	(lb/hr)	193.51	—	—	41.08	152.43	—	152.43	310.77	310.77	152.43	237.89	237.89	152.43
	(lb/yr)	1,695,165	—	—	359,837	1,335,328	—	1,335,328	2,722,345	2,722,345	1,335,328	2,083,916	2,083,916	1,335,328
sesame protein	(lb/hr)	39.07	—	—	—	39.07	—	39.07	—	—	39.07	—	—	39.07
	(lb/yr)	342,253	—	—	—	342,253	—	342,253	—	—	342,253	—	—	342,253
lactic acid	(lb/hr)	1.25	—	—	—	1.25	—	1.25	—	—	1.25	—	—	1.25
	(lb/yr)	10,950	—	—	—	10,950	—	10,950	—	—	10,950	—	—	10,950
misc. solids	(lb/hr)	37.77	—	—	—	37.77	—	37.77	—	—	37.77	—	—	37.77
	(lb/yr)	330,821	—	—	—	330,821	—	330,821	—	—	330,821	—	—	330,821
HCl	(lb/hr)	0.17	—	—	—	0.17	—	0.17	—	—	0.17	—	—	0.17
	(lb/yr)	1,472	—	—	—	1,472	—	1,472	—	—	1,472	—	—	1,472
yeast extract	(lb/hr)	10.25	—	—	—	10.25	—	10.25	—	—	10.25	—	—	10.25
	(lb/yr)	89,790	—	—	—	89,790	—	89,790	—	—	89,790	—	—	89,790
other components	(lb/hr)	0.47	—	—	—	0.47	—	0.47	—	—	0.47	—	—	0.47
	(lb/yr)	4,117	—	—	—	4,117	—	4,117	—	—	4,117	—	—	4,117
ethanol	(lb/hr)	0.01	—	—	—	0.01	—	0.01	—	—	0.01	—	—	0.01
	(lb/yr)	105	—	—	—	105	—	105	—	—	105	—	—	105
hydrogenated oil	(lb/hr)	17.13	—	—	—	17.13	—	17.13	—	—	17.13	—	—	17.13
	(lb/yr)	150,015	—	—	—	150,015	—	150,015	—	—	150,015	—	—	150,015
methyl cellulose	(lb/hr)	1.60	—	—	—	1.60	—	1.60	—	—	1.60	—	—	1.60
	(lb/yr)	14,055	—	—	—	14,055	—	14,055	—	—	14,055	—	—	14,055
seasoning mix	(lb/hr)	6.85	—	—	—	6.85	—	6.85	—	—	6.85	—	—	6.85
	(lb/yr)	60,006	—	—	—	60,006	—	60,006	—	—	60,006	—	—	60,006
breeding batter	(lb/hr)	30.00	—	—	—	30.00	0.01	30.00	—	—	30.00	—	—	30.00
	(lb/yr)	262,800	—	—	—	262,800	44	262,756	—	—	262,756	—	—	262,756
canola oil	(lb/hr)	—	45.00	9.50	—	45.00	0.46	44.54	—	—	44.54	—	—	44.54
	(lb/yr)	—	394,200	83,220	—	394,200	4,030	390,170	—	—	390,170	—	—	390,170

4.4.4 Energy Demand

The energy required per year to power the equipment in block 4 is outlined in Table 4.4.2. It was assumed that the plant operates non-stop the entire year, except for periodic cleaning. Since the frying oil will quickly degrade from constant use, the entire volume of frying oil must be removed every 4 days; it was assumed that cleaning and oil replacement will take 2 hours, resulting in 8,577 hours of electricity usage per year. The battering/breading machine, de-oiling screen, cooling tunnel, and flash freeze tunnel will be cleaned every 8 days. It was assumed that cleaning for each piece of equipment will take 1 hour, so each has 8,714 hours of electricity usage per year. The extruder will be cleaned every 4 days to prevent buildup inside the barrel. The assumed cleaning time for this equipment is also 1 hour, resulting in 8,668 hours of electricity usage per year. Power requirements for the extruder, fryer, and both pieces of cooling equipment were calculated in Section 3.5.4. Utilities for the coolers include electricity and cooling water. All of the pumps in this block are peristaltic and have negligible power requirements.

Table 4.4.3 Block 4 Energy Requirements

Equipment Type	Equipment ID	Power Requirement (W)	Hours of operation (h/yr)	Energy Requirement (kWh/yr)
Mixers	V4.01, a-c	7,072	2,190	15,488
	V4.02	746	2,920	2,178
Extruder	X4.01	12,101	8,688	105,133
Batter/Breading machine	X4.02	3,700	8,714	32,242
Fryer*	E4.01	47,747	8,577	409,526
De-oiler	X4.03	3,000	8,714	26,142
Coolers	E4.02	-27,004	8,714	235,312
	E4.03	-12,663	8,714	110,342
Pumps	P4.01	n/a	n/a	n/a
	P4.02	n/a	n/a	n/a
	P4.03	n/a	n/a	n/a
Total				936,363

*Natural gas power source

SECTION 5: ECONOMICS

5.1 Fixed Capital Investment

The fixed capital investment for this plant includes all equipment costs and costs associated with designing and installing the equipment in a brownfield plant. The total equipment cost was determined to be \$1.68 MM as outlined in Tables 5.1.1 and 5.1.2. Other fixed capital costs were calculated with typical estimation factors for a fluids-solids processing plant (Towler & Sinnott, 2013). The factor for piping was modified to account for higher prices associated with 304/316 stainless steel, both of which are food grade. This resulted in a significantly larger total for fixed capital costs. The capital cost of offsites was reduced to 0.2 because a brownfield site will be used, which requires less additions to existing infrastructure. A detailed list of additional installation costs is provided in Table 5.1.3. The total fixed capital investment (FCI) was determined to be \$10.3 MM using an estimation factor of 6.12.

Table 5.1.1 Major Equipment Cost

Block	Equipment ID	Equipment Type	Unit Cost	Number of Units	Cost	Source
Block 1	P1.05a,b	Compressor	\$ 40,440	2	\$ 80,880	Peters et al. (2003)
	V1.01, V1.02	Mixing tank	\$ 7,500	2	\$ 15,000	Perry Biehler (n.d.)
	V1.03, V1.04a,b	Mixing tank	\$ 7,144	3	\$21,430	INDCO (n.d.-b)
	X1.01	Air screen cleaner	\$ 7,800	1	\$ 7,800	Julite (n.d.)/Alibaba (n.d.-a)
	X1.02	Settling tank	\$ 12,000	1	\$ 12,000	Alibaba (n.d.-f)
	X1.03	Rotary sieve	\$ 2,500	1	\$ 2,500	Prater Industries (n.d.)
	X1.04	Oil press machine	\$ 8,649	1	\$ 8,649	Mini Oil Mills (n.d.)
	X1.05a,b	Flash drum	\$ 15,968	1	\$ 15,968	A Louis Supply Company (ALSCO) (n.d.)
	X1.06a,b	Flash drum	\$ 22,000	2	\$ 44,000	Aspen Plus V14
		Screw feeder	\$ 180	3	\$ 540	Alibaba (n.d.-b)
X1.07a,b	Bag Filter	\$1,850	2	\$3,700	C1D1 Labs (2023)	
Block 2	R2.02	Digestor	\$ 20,000	2	\$ 40,000	Wenzhou Yinou Machinery Co. (n.d)
	R2.01	Seed tank	\$ 15,000	1	\$ 15,000	Jiangsu Xuyang Chem inc (n.d.)

	X2.02	Centrifuge	\$ 19,800	1	\$ 19,800	Lianing Fuyi Machinery Co (n.d.)
	X2.04	Ultrafiltration modules	\$ 185	51	\$ 9,435	Synder Filtration (n.d.)
	X2.01	Milling machine	\$ 14,622	3	\$ 43,866	Pleasant Hill Grain (n.d.)
	X2.05-6	LLE column	\$ 14,249	2	\$ 28,498	USA lab (n.d.-b)
	X2.03	Screw press	\$ 1,320	1	\$ 1,320	Henen Kelefu (n.d.)
	X2.07	Evaporator	\$ 34,995	1	\$ 34,995	EZ-vap (n.d.)
Block 3	V3.01a-d	Mixer	\$7,500	4	\$ 30,000	Glacier Tanks (n.d.-a)
	V3.02a-d	Mixer	\$9,000	4	\$ 36,000	GW Kent (n.d.)
	R3.01a-d	Fermenter	\$18,000	4	\$ 72,000 ¹	Misailidis & Petrides (2020)
	R3.02a-d	Fermenter	\$46,500	4	\$ 184,000 ¹	Misailidis & Petrides (2020)
	R3.03	Autolysis Vessel	\$21,200	1	\$ 21,200	Glacier Tanks (n.d.-b)
	X3.01	Disc Stack Centrifuge	\$15,000	1	\$ 15,000	Nanjing Fivemen Machine (n.d.)
	X3.02	Disc Stack Centrifuge	\$15,000	1	\$ 15,000	Nanjing Fivemen Machine (n.d.)
Block 4	V4.01 a-c	Mixer	\$ 43,531	3	\$ 130,593	Webstaurant Store (n.d.-d)
	V4.02 a,b	Mixer	\$ 6,153	2	\$ 13,026	Cedar Stone Industry (n.d.)
	X4.01	Extruder	\$ 20,000	1	\$ 20,000	Made-in-China (n.d.-a)

X4.02	Battering/breading machine	\$ 11,900	1	\$ 11,900	Made-in-China (n.d.-b)
E4.01	Deep fryer	\$ 21,000	1	\$ 21,000	Made-in-China (n.d.-c)
X4.03	De-oiling screen	\$ 1,200	1	\$ 1,200	Made-in-China (n.d.-d)
E4.02	Cooling tunnel	\$ 21,600	1	\$ 21,600	Made-in-China (n.d.-e)
E4.03	Blast freeze tunnel	\$ 10,000	1	\$ 10,000	Alibaba (n.d.-c)

Total

\$ 1,007,900

¹ Prices based on general costing. See appendix 5.1.01 for details

Table 5.1.2 Ancillary Equipment Cost

Equipment Type	Equipment ID	Unit Cost	Number of Units	Cost	Source
Pumps	P1.01	\$5,662	2	\$ 11,324	Peters et al. (2003)
	P1.02	\$5,662	2	\$ 11,324	Peters et al. (2003)
	P1.03	\$5,662	2	\$ 11,324	Peters et al. (2003)
	P1.04	\$5,662	4	\$ 22,648	Peters et al. (2003)
	P1.06	\$1,800	4	\$ 7,200	Lab 1st (n.d.)
	P1.07	\$1,800	4	\$ 7,200	Lab 1st (n.d.)
	P1.08	\$3,640	2	\$ 7,280	Peters et al. (2003)
	P1.09	\$3,640	2	\$7,280	Peters et al. (2003)
	P1.10	\$1,800	2	\$3,600	Lab 1st (n.d.)
	P2.01	\$3,600	2	\$ 7,200	Peters et al. (2003)
	P2.02	\$ 659	2	\$ 659	Donjoy Technology (n.d.)
	P2.03	\$ 233	2	\$ 466	Baoding Chuangrui (n.d.)
	P2.04	\$ 659	3	\$ 1,977	Donjoy Technology (n.d.)
	P2.05	\$ 205	2	\$ 410	Hephis Aqua Tech (n.d.)
		Spare pumps of P2.02 and P2.04	\$ 659	3	\$ 1,977
	Infiltrer pump	\$ 659	4	\$ 1,977	Donjoy Technology (n.d.)

	P3.01	\$ 7,930	2	\$15,860 Peters et al. (2003)
	P3.02a-d	\$ 900	6	\$ 5,400 Lab 1st (n.d.)
	P3.03a-d	\$ 1,400	6	\$ 8,400 Chonry Peristaltic Pump (n.d.)
	P3.04	\$ 7,280	6	\$ 43,680 Peters et al. (2003)
	P3.05	\$ 8,090	2	\$ 16,180 Peters et al. (2003)
	P3.06	\$ 4,850	2	\$ 9,700 Peters et al. (2003)
	P4.01	\$ 1,300	2	\$ 2,600 MSE Supplies (n.d.)
	P4.02	\$ 1,300	2	\$ 2,600 MSE Supplies (n.d.)
	P4.03	\$ 1,300	2	\$ 2,600 MSE Supplies (n.d.)
Heat Exchangers	E1.01	\$ 2,582	1	\$ 2,582 Grainger (n.d.-a)
	E1.02	\$ 6,000	1	\$ 6,000 Alibaba (n.d.)
	E1.03	\$ 5,745	2	\$ 11,490 Grainger (n.d.-a)
	E1.04	\$ 5,745	2	\$ 11,490 Grainger (n.d.-a)
	E2.01	\$ 1,300	1	\$ 1,300 Wenzhou Xusheng Machinery (n.d.)
	E2.02	\$ 1,300	1	\$ 1,300 Wenzhou Xusheng Machinery (n.d.)
	E3.01	\$ 2,580	1	\$ 2,580 Grainger (n.d.-a)
	E3.02	\$ 2,500	1	\$ 2,580 Grainger (n.d.-a)
	E3.03	\$ 2,500	1	\$ 2,580 Grainger (n.d.-a)

Tanks					
	TK1.01	\$ 3,000	1	\$ 3,000	DK Tank & Pipe (n.d.)
	TK1.02	\$ 5,136	1	\$ 5,136	National Tank Outlet (n.d.-a)
	TK1.03	\$ 3,667	1	\$ 3,667	Plastic-Mart (n.d.)
	TK1.04	\$ 5,136	1	\$ 5,136	National Tank Outlet (n.d.-a)
	TK1.05	\$ 9,533	1	\$ 9,533	National Tank Outlet (n.d.-b)
	TK2.02	\$ 15,868	1	\$15,686	Saeed, W. (2014)
	TK2.03	\$ 14,122	1	\$ 14,122	Saeed, W. (2014)
	TK2.04	\$ 45,915	1	\$ 45,915	Saeed, W. (2014)
	TK2.05	\$ 38,350	1	\$ 38,350	Saeed, W. (2014)
	TK2.06	\$ 5,325	1	\$ 5,325	INDCO (n.d.-a)
	TK2.07	\$ 149,077	1	\$ 149,077	Saeed, W. (2014)
	TK2.08	\$2,255	1	\$2,255	McMaster-Carr (n.d.)
	TK3.01	\$ 9,940	2	\$19,880	Supplyline Industrial (n.d.-a)
	TK3.02	\$ 11,290	3	\$33,870	Supplyline Industrial (n.d.-b)
	TK4.01	\$ 79	2	\$ 158	Uline (n.d.-c)
	TK4.02	\$ 2,900	1	\$ 2,900	Alibaba (n.d.-d)
	TK4.03	\$ 1,833	1	\$ 1,833	National Tank Outlet (n.d.-a)
	TK4.04	\$ 8,684	1	\$ 8,684	Alibaba (n.d.-e)

	TK4.05	\$ 8,684	1	\$ 8,684 Alibaba (n.d.-e)
	TK4.06	\$ 2,950	1	\$ 2,950 National Tank Outlet (n.d.-b)
Total				\$ 628,929

Table 5.1.3 Project Fixed Capital Costs

Item	Installation factor	Price (\$)
Buildings	0.3	\$ 504,247
Installation	0.5	\$ 840,413
Piping	2.08	\$ 3,496,118
Instrumentation & controls	0.3	\$ 504,248
Electrical	0.2	\$ 336,165
Civil	0.3	\$ 504,248
Lagging & paint	0.1	\$ 168,083
Total ISBL cost		\$ 6,353,523
Offsites	0.2	\$ 336,165
Design & engineering	0.25	\$ 420,207
Contingency	0.1	\$ 168,083
Total		\$ 6,773,730

5.2 Variable Operating Costs

Pricing for all raw materials was found from various online sources and multiplied by required feed quantities to determine the total cost per year. These costs are outlined in Table 5.2.1, and it was found that total raw material cost is \$8.8MM per year. Table 5.2.2 lists total utility pricing per year. Utility pricing for cooling water, steam, and solid and liquid waste disposal was adapted from Peters et al. (2003) to reflect today's cost. An estimation for current values of utility pricing were determined using the Chemical Engineering Plant Cost Index (CEPCI) utilizing a value of 800 to represent today's costs. As of 2022, the industrial cost of electricity is 8¢ per kWh (EIA, 2023). The cost of process water is roughly \$2/1000 gal (Towler and Sinnott, 2012). The cost of compressed air was approximated to be \$0.40 per 1000 ft³, which includes pump and energy costs (Nex Flow, 2020). The cost of natural gas for heating was determined from the cost to generate 1 kWh of energy from natural gas, and was determined to be \$0.08 per 100 kWh (Kyle's Converter, 2024; EIA, 2024). In block 1, 1,000 lbs of butane loss is accounted for annually. The startup volume of butane required is approximately 13,900 lbs of butane which should cost about \$6,500, however, the butane is recycled and the cost can be distributed over the 20 year expected plant life, averaging out to \$330/year.

Table 5.2.1 Raw Materials

Block	Material	Price (\$/lb)	Amount (lb/yr)	Price (\$/yr)	Source
Block 1	Sesame seeds	\$ 1.24	3520031	\$ 4,363,078	Index Box (2024)
	NaOH	\$ 1.12	4,412	\$ 4,942	Level 7 Chemical (n.d.)
	Na ₂ CO ₃	\$ 0.74	330,916	\$ 330,916	CQ Concepts (n.d.)
	Butane	\$ 13.00	1,550	\$ 7,099	USA Lab (n.d.-a)
	Process water (\$/10 gal)	\$ 0.04	22,061,038	\$ 91,241	Peters et al. (2003)
	Sulfuric acid 96%	\$ 0.38	383,724	\$ 145,815	Lab Alley (n.d.)
	Sesame seed oil packaging (\$/unit)	\$615	355	\$ 218,325	Uline (n.d. b)
Block 2	HCl	\$ 1.76	76,825	\$ 135,212	Alliance Chemical (n.d.)
	NaOH	\$ 1.12	18,922	\$ 21,193	Level 7 Chemical (n.d.)
	H ₂ SO ₄	\$ 0.38	1,426,128	\$ 542,784	Medium (2023)
	Trioctylamine	\$ 178.17	7.2	\$ 1,283	Sigma Aldrich (n.d.)
	Octanol	\$ 0.58	4,310	\$ 2,500	EChem (n.d.)
	Process water (\$/10 gal)	\$ 0.04	1,413,570	\$ 5,846	Peters et al. (2003)
	Beet Molasses	\$ 0.40	15,291	\$ 6,116	Selina Wamucii (2024a)
Block 3	Lactic acid packaging (\$/unit)	\$ 35.07	100	\$ 3,507	BagCorp (n.d.)
	Brewer's yeast	\$ 1.63	397	\$ 647	Bakers Authority (2024)
	Sugar cane molasses	\$ 0.40	976,391	\$ 398,527	Selina Wamucii (2024a)

	Process water (\$/10 gal)	\$ 0.04	396,733	\$ 1,641	Peters et al. (2003)
Block 4	HPMC	\$ 10.75	150,015	\$ 231,023	Bulk Supplements (n.d.)
	Hydrogenated vegetable oil	\$ 1.54	14,055	\$ 151,095	Webstaurant Store (n.d. b)
	Seasoning mix	\$ 8.54	60,006	\$ 512,451	My Spice Sage (n.d.)
	Breading	\$ 1.18	262,800	\$ 310,104	Webstaurant Store (n.d. c)
	Batter mix	\$ 2.11	262,800	\$ 554,508	Webstaurant Store (n.d. a)
	Process water (\$/10 gal)	\$ 0.04	79,157	\$ 327	Peters et al. (2003)
	Canola oil	\$ 1.59	477,108	\$ 758,602	Bulk Apothecary (n.d.)
	Bulk nugget packaging (\$/unit)	\$ 43.15	3,318	\$ 143,188	Uline (n.d. a)
Total				\$ 8,766,581	

Table 5.2.2 Utilities

Utility		Amount (units/yr)	Price (\$/unit)	Price (\$/yr)
Electricity	(kWh)	1,994,5597	\$0.08/kWh	\$ 159,564
Cooling water	(gal)	4,193,412	\$0.06/100 gal	\$ 2,617
Steam	(lbs)	2,561,818	\$0.40/100 lbs	\$10,352
Gas heat	(kWh)	979,802	\$0.08/100 kWh	\$765
Compressed air	(ft ³)	83,812,298	\$0.40/1000 ft ³	\$ 33,524
Wastewater treatment and disposal	(lbs)	45,791,511	\$0.09/100 lb	\$ 22,592
Non hazardous waste disposal	(lbs)	1,635,171	\$0.03/lb	\$ 49,372
Hazardous waste disposal	(lbs)	1,077,054	\$0.12/lb	\$ 124,228
Total				\$ 403,017.43

5.3 Fixed Operating Costs

Fixed operating costs include maintenance, property taxes, insurance, and labor (operating labor, supervision/management, and salary overhead). Expenses for insurance, property taxes, and maintenance were estimated by multiplying the ISBL investment with factors from Towler and Sinnott (2013). Insurance and property taxes were estimated to be 1% of the ISBL and OSBL investment, and maintenance expenses were estimated to be 4% of the ISBL investment for a fluids-solids processing plant. Expenses associated with product development were calculated as 5% of the total annual revenues.

Labor requirements were estimated for a fluids-solids process for both continuous and batch processes depending on operating needs for each block. Block 1 requires 4 shift positions because it is a continuous process with solids handling of the raw sesame seeds. Block 2 is also mostly continuous, with 2 solids handling positions around the grinding of the sesame meal, 2 liquid batch handling positions for the batch fermentation, and 2 positions for the continuous downstream liquids process. Block 3 requires 4 shift positions because it is a mostly batch fluids process with the exception of initial yeast cell and molasses handling and some waste handling from the centrifuges. There will be a significant amount of automation and generally no physical handling of the fluids. Block 4 contains mostly continuous processes, except for solids handling for the dough and batter mixers, and therefore requires 5 shift positions. In total there are 19 shift positions, each with 4.8 operators at a \$50,000 salary (Towler & Sinnott, 2013). The total operating labor cost per year is \$4.56 MM. It was assumed that supervision cost is 25% of the operating labor cost, and direct salary overhead cost is 50% of both the operating and supervisory labor costs. The total fixed operating cost is \$10 MM per year, as outlined in Table 5.3.1.

Table 5.3.1 Fixed Operating Costs

Item	Price (\$/yr)
Operating labor	\$ 4,560,000
Supervision/management	\$ 1,140,000
Direct salary overhead	\$ 2,850,000
Insurance	\$ 67,737
Property taxes	\$ 67,737
Maintenance	\$ 254,141
Research and Development	\$ 997,939
Total	\$ 9,961,686

5.4 Revenues

The primary sources of revenue from this process are the sale of toasted sesame oil and plant-based chicken nuggets. Recovered lactic acid from the seed cake fermentation may also be sold as a side product, but has negligible effects on annual revenues because a relatively small quantity is produced. Revenues from the sale of the sesame oil and plant-based nuggets was assumed to be half of the retail price of similar products, because both will be sold in bulk quantities. Sesame seed oil from 365 by Whole Foods Market is \$0.87/fl.oz. and the price of Morningstar Farms Chik'n nuggets is around \$0.45/oz. Bulk prices for the sesame oil and plant-based nuggets are \$0.46/fl.oz. and \$0.25/oz., respectively. Four possible economic scenarios are provided below to determine the most profitable option.

5.5 Cash Flow Analysis

It was assumed that one year is required for construction and installment in an existing site; 50% of the fixed capital investment was allocated to the first year capital expense. In the second year, a full plant shakedown at half capacity will occur during the first half of the year, followed by full scale production for the remaining six months. Costs associated with year 2 operations are 50% of the fixed capital investment, working capital (assumed to be 10% of the FCI), 100% of the fixed costs of production (FCOP), and 75% of the variable costs of production (VCOP). Revenues are assumed to be 75% of the design basis revenue. From the third year until shutdown of the plant, the cost of production is the total of both the FCOP and VCOP; 100% of the design basis revenue is earned. Discounted cash flow was calculated using the straight line method of depreciation over 10 years. The total tax rate is 25%. The lifetime of the plant is assumed to be 20 years; in year 20, working capital is reclaimed and equipment is sold for 10% of the purchase price.

5.5.1 Scenario 1: Baseline

In this scenario, all three products (sesame oil, lactic acid, and plant-based nuggets) are sold at wholesale prices. At the designed scale, 14.4MM oz/yr of toasted sesame oil are produced, so the estimated revenue is \$6.9 MM per year. The production rate of nuggets was determined to be 3.3MM lbs/yr. Annual revenues from the plant-based chicken nuggets is \$13.0 MM. Lactic acid can be sold for \$0.70/lb; the production rate is 53M lbs/yr, resulting in \$37,310 revenue from lactic acid per year. Total revenue from the sale of these products is \$20.0 MM per year. The cash flow analysis can be found in Figure 5.5.1. The initial FCI was depreciated over the first 10 years of the plant lifetime, resulting in an after tax cash flow of \$900M up to year 10 and \$670M in the remaining plant life. The before tax cash flow remains constant at \$732M,

excluding years assigned to plant construction and shutdown. The internal rate of return (IRR) in this scenario is 6.27%, indicating this project is not a rapidly growing investment; this IRR is only reasonable for a new product in a very stable market. The lactic acid recovery and purification steps in block 2 were identified as economically undesirable because the associated capital and operating costs were not offset by revenues from the sale of lactic acid. This information guided the following economic scenarios.

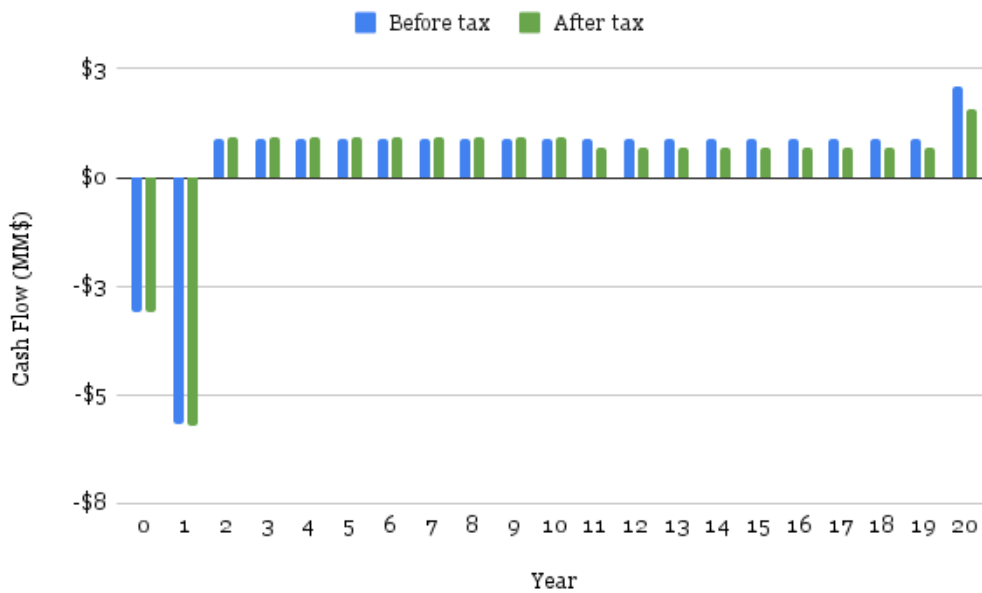

Figure 5.5.1 Scenario 1 Cash Flow Analysis

5.5.2 Scenario 2: No lactic acid recovery

A second analysis was performed in which the costs associated with lactic acid recovery were eliminated, and it was assumed no lactic acid would be sold as a side product. The costs associated with equipment, materials, and utilities to recover the lactic acid exceed the revenues from sales, rendering this section not profitable. This reduces the total equipment cost to \$1.34MM and the total FCI to \$8.21MM. Materials costs are reduced to \$8.2MM, and utilities to

\$241M. The total operating costs per year are \$17.8MM, and total revenues without lactic acid sales are \$19.92MM. The cash flow is presented in Figure 5.5.2; similar to scenario 1, the FCI was depreciated over the first 10 years of the plant life, resulting in an after tax cash flow of \$1.8MM in the first 10 years, followed by \$1.6MM in the remaining years of operation. The before tax cash flow remains constant, except during construction and shutdown of the plant, at \$19.9MM. The IRR for this scenario was determined to be 24.0%. This suggests that removing the lactic acid recovery from the process notably increases ROI. However, this IRR is still below the acceptable threshold for a somewhat high risk project.

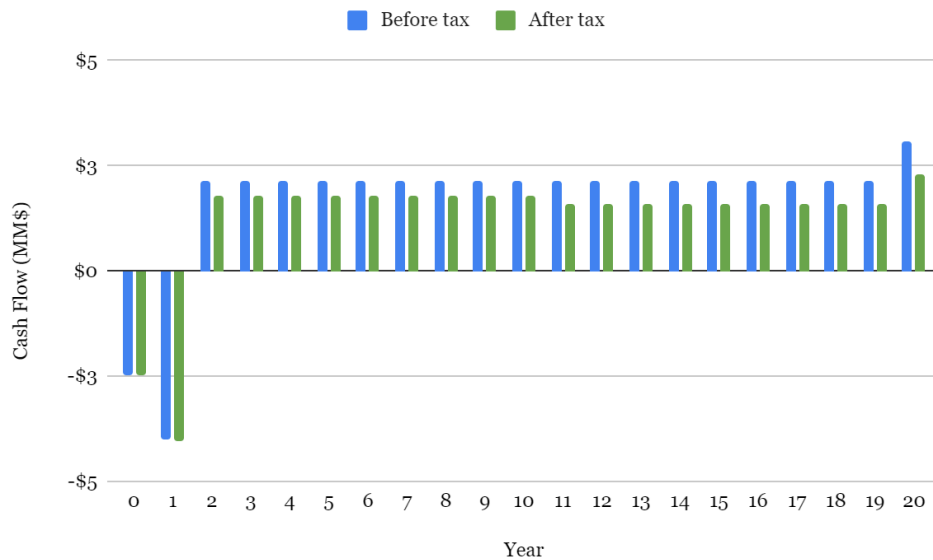

Figure 5.5.2 Scenario 2 Cash Flow Analysis

5.5.3 Scenario 3: Sesame seed oil production only

Another analysis was performed in which only toasted sesame oil is produced. This scenario was used to determine if the process steps to make the plant-based nuggets are less economically favorable than exclusively producing sesame seed oil would be. The total equipment cost and FCI are \$348M and \$2.1MM, respectively. This scenario reduces the

materials cost to \$4.99MM per year and utilities cost to \$131M per year. The design basis revenue from sales of sesame oil is \$6.90MM per year, and total cost of production is \$7.0MM per year. Figure 5.5.3 provides a cash flow analysis for production of sesame seed oil only; the scale of the vertical axis was decreased to M\$ as opposed to MM\$ found in the other scenarios. The cash flow is negative for all of the plant lifespan, except for shutdown where the equipment is sold. The IRR for this scenario is reduced to effectively 0%, indicating it is not economically feasible. This design is not recommended because it generates negative cash flows and has a poor rate of return. It also may be difficult to break into a well-developed existing market, whereas the sesame-based vegan nuggets are a newer product in an expanding market.

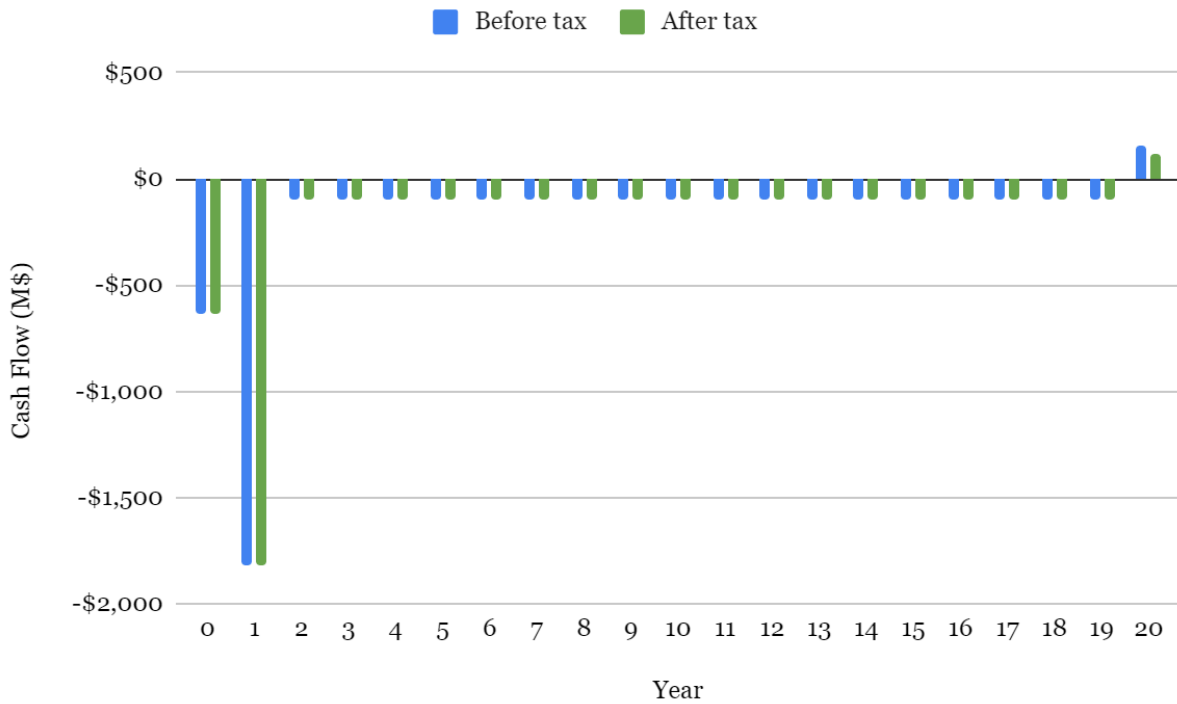

Figure 5.5.3 Scenario 3 Cash Flow Analysis

5.5.4 Scenario 4: No yeast extract block

A fourth option was considered in which the yeast extract fermentation block is eliminated, and yeast extract is instead purchased as a raw material. Due to the plant scale, capital costs in the yeast extract block were high in comparison to other areas of the process. This was identified as an opportunity to improve the profitability of this project. In addition to removing the yeast extract block, the lactic acid separation was removed, similar to the second scenario. Because the yeast extract block and lactic acid removal are removed, the total equipment cost for this scenario is reduced to \$807M, almost \$1MM lower than the original scenario. This leads to a total FCI of around \$4.9MM. Materials costs increase and utility costs are reduced slightly at \$9.1MM and \$354M, respectively. The cost of the yeast extract supply is approximately \$366,000 per year, while around \$398,000 is saved from eliminating molasses as a raw material expense (Selina Wamucii, 2024b). Additional water must be added at the final mixing stage to maintain the water content in the final product, which costs an additional \$1,640 per year. The large reduction in capital costs and small reduction in operating costs increased the profitability of the plant. The IRR for this scenario is 64.6% with an annual average cash flow of \$2.16 MM over the first ten 10 years, indicating that this investment is promising. After the 10 year depreciation factor, the after tax cash flow remains around \$2.62MM, showing that the process is still very profitable. However, the price of the final products affects the profitability significantly, as a 10% reduction in prices of the nugget product results in an IRR of 25.5% and an average cash flow of \$1.4MM after taxes in the first 10 years of the plant lifespan. This must be taken into account in the investment of this process, and the market must be stable enough to ensure profitability. While the economics of this are most favorable, the yeast extract purchased in these quantities is likely to be spent brewer's yeast which can contain significant bitter notes.

If product testing can ensure a positive reception of this blend to the consumer, the market projections appear strongest in this layout, and this scenario is recommended for the production of sesame-based chicken nuggets.

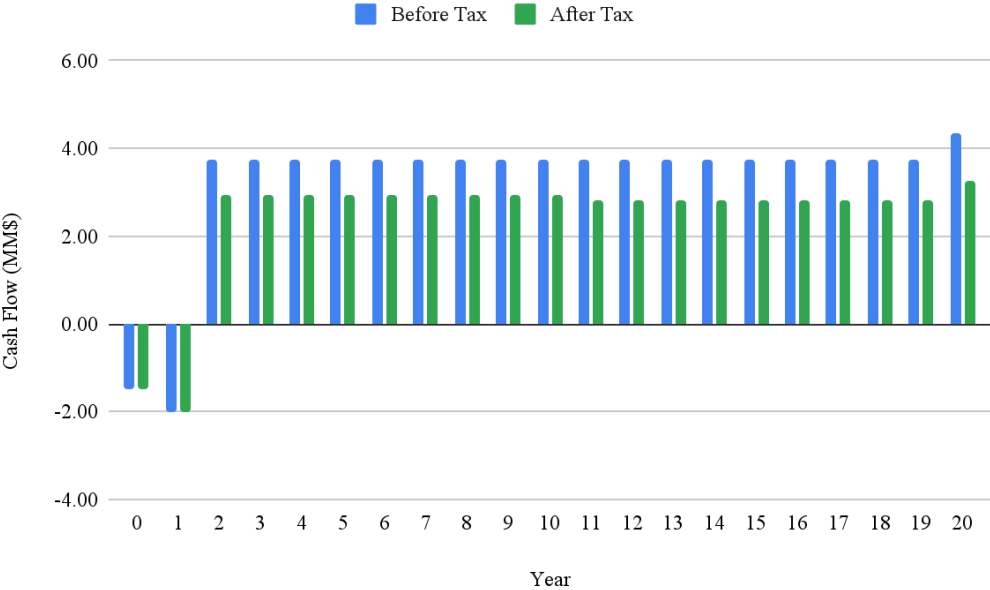

Figure 5.5.4 Scenario 4 Cash Flow Analysis

SECTION 6: ENVIRONMENTAL, HEALTH, AND SOCIAL CONSIDERATIONS

6.1 Chemical Hazards and Compatibility

This process requires numerous hazardous chemicals that can have adverse effects if combined. Listed below in Table 6.1.1 are the hazardous chemicals in each block. Even though water does not present any hazards on its own, it is included in the list of hazardous chemicals for Block 1 because of the incompatibilities with the other chemicals used in the process. Block 2, including has the most significant hazards in the process, so extra care must be taken to ensure safety protocols are in place to prevent unnecessary incidents.

Table 6.1.1 Overview of Hazardous Chemicals

Block 1	Block 2	Block 3
Lye Sodium Bicarbonate Sodium Hydroxide	Lactic Acid	Ethanol
Sulfuric Acid	Hydrochloric Acid	Carbon Dioxide
Butane	Fuming Sulfuric Acid Trioctylamine 1-Octanol Sodium Hydroxide Carbon Dioxide	

Tables 6.1.2-4 identify the major chemical hazards in each block and provide some exposure limit values. Block 1 has some significant hazards, including sodium hydroxide,

sulfuric acid, and butane. Because sodium hydroxide is a strong base, care must be taken to prevent human contact with this chemical, so mitigative measures for the storage vessel, like frequent inspection, spill mitigation equipment, and decontamination showers should be accessible. Workers should use proper PPE when handling caustic solutions for the entire process. In a similar vein, block 2 also has acidic and basic threats that should be reduced with accessible mitigation equipment, proper maintenance, and employee training. Another threat present in both blocks is flammable organic solvents. These can be partially managed through vigilant usage of leak detection through pressure and level sensors. An additional aspect of safe operations is the physical placement of these extraction operations. They should be far away from potential heat sources. As a result they will have physical distance from both the fryer and caustic solutions to reduce ignition sources. Trioctylamine is largely an environmental hazard, and can be managed through proper waste disposal procedures. The main threat of block 3 is carbon dioxide gas acting as an asphyxiant. This can be managed by ensuring the fermenter region of block 3 has adequate ventilation sources. Block 2 also produces some carbon dioxide but this is a much lower outflow, leading to a lower risk of asphyxiation. While ethanol can be flammable as a vapor, the low temperature and concentration of its synthesis renders it a low threat that is adequately managed with normal operational procedures.

Table 6.1.2 Hazardous chemicals - Block 1

Chemical	Flammability (NFPA)	Reactivity (NFPA)	Health (NFPA)	OSHA PEL (mg/m ³)	NIOSH REL (mg/m ³)	ACGIH TLV (mg/m ³)	Source
Na ₂ CO ₃	0	1	2	10	2	N/A	TATA Chemicals (2013)
NaOH	0	1	3	2 ³	2	2	NJ Health (2015)
H ₂ SO ₄	0	2, W	3	1	1	0.2	NJ Health (2016)
Butane	4	0	1	n/a	1,900	2,100	OSHA (2020)

Table 6.1.3 Hazardous chemicals - Block 2

Chemical	Flammability (NFPA)	Reactivity (NFPA)	Health (NFPA)	OSHA PEL (mg/m ³)	NIOSH REL (mg/m ³)	ACGIH TLV (mg/m ³)	Source
Lactic Acid	1	1	2	n/a	n/a	n/a	Thermo Fisher Scientific (2021)
HCl	0	1, W	3	7	7	2	OSHA (2024)
Fuming Sulfuric Acid	0	2, W	3	1	1	0.2	OSHA (2021b)
TOA	1	0	2	n/a	n/a	n/a	Chemical Land (n.d.)
1-Octanol	2	0	1	n/a	n/a	n/a	NOAA (2022)
Sodium Hydroxide	0	1	3	2	2	2	OSHA (2021a)
Carbon Dioxide	0	0	2	9,000	9,000	9,000	(OSHA, 2022)

Table 6.1.4 Hazardous chemicals - Block 3

Chemical	Flammability (NFPA)	Reactivity (NFPA)	Health (NFPA)	OSHA PEL (mg/m ³)	NIOSH REL (mg/m ³)	ACGIH TLV (mg/m ³)	Source
Ethanol	3	0	2	1,900	1,900	1,900	OSHA (2023)
Carbon Dioxide	0	0	2	9,000	9,000	9,000	OSHA (2022)

The compatibility of these chemicals can be analyzed using CAMEO, a database of chemicals funded by NOAA. Below, in Figure 6.1.01, are the hazards for all chemicals in the process. There are many chemicals that are listed as ‘incompatible’ if mixed together. Notably, the strong acids and bases from block 2 are incompatible with most of the other chemicals in the process. Combining many of these chemicals results in heat, gaseous, and flammability hazards that could lead to explosion or injury to facility workers. Care should be taken to prevent any leakages from occurring that could cause an unintended combination of incompatible chemicals. Additionally, stringent protocols for the storage and handling of the hazardous chemicals should be in place to prevent any unintended reactions from occurring.

Figure 6.1.1 Chemical Reactivity Chart - Overall Process (continued on next page)

	SODIUM HYDROXIDE SOLUTION		
SODIUM BICARBONATE	Caution ■ Generates gas	SODIUM BICARBONATE	
SULFURIC ACID, FUMING	Incompatible ■ Corrosive Generates gas Generates heat Intense or explosive reaction Toxic	Incompatible ■ Generates gas Generates heat Intense or explosive reaction	SULFURIC ACID, FUMING
OCTANOL	Incompatible ■ Flammable Generates gas Generates heat	Compatible ■	Incompatible ■ Explosive Flammable Generates gas Intense or explosive reaction Toxic
BUTANE	Compatible ■	Compatible ■	Incompatible ■ Generates gas Generates heat Toxic
WATER	Caution ■ Corrosive Generates gas Generates heat Toxic	Caution ■ Generates gas	Caution ■ Corrosive Generates gas Generates heat Toxic
HYDROCHLORIC ACID, SOLUTION	Incompatible ■ Corrosive Generates gas Generates heat Intense or explosive reaction Toxic	Incompatible ■ Generates gas Generates heat Intense or explosive reaction	Incompatible ■ Corrosive Explosive Flammable Generates gas Generates heat Intense or explosive reaction Toxic
LACTIC ACID	Incompatible ■ Corrosive Flammable Generates gas Generates heat Intense or explosive reaction Toxic	Caution ■ Generates gas Generates heat	Incompatible ■ Explosive Flammable Generates gas Generates heat Intense or explosive reaction Toxic
ETHANOL	Incompatible ■ Flammable Generates gas Generates heat	Compatible ■	Incompatible ■ Explosive Flammable Generates gas Intense or explosive reaction Toxic
CARBON DIOXIDE	Incompatible ■ Corrosive Generates heat	Incompatible ■ Generates gas Generates heat	Incompatible ■ Explosive Generates gas Generates heat Toxic

Figure 6.1.01 Chemical Reactivity Chart - Overall Process (continued)

	OCTANOL					
BUTANE	Compatible ■	BUTANE				
WATER	Compatible ■	Compatible ■	WATER			
HYDROCHLORIC ACID, SOLUTION	Caution ■ Generates heat	Compatible ■	Caution ■ Corrosive Generates gas Generates heat	HYDROCHLORIC ACID, SOLUTION		
LACTIC ACID	Caution ■ Flammable Generates gas Generates heat Intense or explosive reaction	Compatible ■	Compatible ■	Incompatible ■ Flammable Generates gas Generates heat Toxic	LACTIC ACID	
ETHANOL	Compatible ■	Compatible ■	Compatible ■	Caution ■ Generates heat	Caution ■ Flammable Generates gas Generates heat Intense or explosive reaction	ETHANOL
CARBON DIOXIDE	Compatible ■	Compatible ■	Caution ■ Corrosive Generates heat	Caution ■ Corrosive Generates heat	Compatible ■	Compatible ■

6.2 Equipment Failure

6.2.1 Reactors

Failures of the fermenters may result in off-spec products and disruptions to downstream processes. Causes of failure include loss of temperature control, incorrect pH, overfeeding the bioreactor, and loss of agitation or aeration. These failures may be caused by human error or loss of power to equipment. Insufficient cooling of a fermentation can denature the proteins, while excess cooling can slow the fermentation time frame and may result in cell death. Safeguards for temperature control include indicators and alarms or a back-up cooling system. Loss of agitation or aeration can prevent sufficient cell and protein growth during a fermentation. Risk of this occurring can be reduced by ensuring a back-up power supply is available. Incorrect feeds and pH in the fermenters can be safeguarded with dedicated charge tanks and pH indicators.

6.2.2 Separations Equipment

Separation equipment failure modes are leaks, incorrect temperature or pressure, and damage to column internals. Leaks may be caused by corrosion or failure of piping connections to a column/drum. These can be prevented by using appropriate materials of construction, routine maintenance, and inspections. High or low temperature or pressure in separations equipment can be caused by instrumentation failure, presence of contaminants, or human error. Instrumentation inspections and maintenance should be used to ensure equipment works as intended. Redundancy in instrumentation can also safeguard against these failures. Damage to column internals is caused by contaminants, corrosion, fouling, overpressure, and vibrations. Inspections prior to start-up and after shut-down, as well as maintenance during downtimes, can help reduce risk of this occurring. Appropriate materials of construction for the chemicals being used are an important safeguard against column damage.

6.2.3 Centrifuges

Common failure modes for a disc stack centrifuge include excessive vibration and excess heat due to friction, both of which can impact the process. Excessive vibration can be caused by numerous issues, including a damaged disc, incorrect installation, and wear over time, but can be detected through vibration detection devices. Excessive heat can be caused by any of the moving parts coming into contact while the centrifuge is running. These parts include the discs, column, and brake. To prevent overheating, a temperature indicator can be installed, which will automatically shut off the centrifuge if temperature is too high.

6.2.4 Pumps

The most common failures associated with pumps are deadheading and cavitation. Deadheading is caused by a lack of flow through a pump, but can be prevented with alarms to indicate lack of flow and proper valve use. Cavitation occurs when there is insufficient pressure at the pump outlet. This generates air bubbles and may result in leaks. Safeguards for pump failures include power indicators, back-up power supply, flow alarms, and overpressure protection. All pumps in the plant will have a backup to reduce disruptions and risks in case of pump failure. This also allows for routine maintenance to be done without disrupting the process.

6.2.5 Heat Exchangers

Shell and tube heat exchangers are at risk of tube leaks, which may contaminate the process liquid being heated/cooled. Other failure modes include loss of heating/cooling and inadequate heat transfer. The main causes of these failures are corrosion, fouling, and vibrations in or around the heat exchanger, as well as power losses. Safeguards include routine inspections and maintenance of equipment, temperature indicators and alarms, flow alarms, and equipment

design that is easy to clean. Corrosion can be prevented by choosing materials of construction that are compatible with chemicals used in the process.

6.2.6 Pipes

Possible failure modes for the piping in this process are internal corrosion, overpressure, and weld failure. Corrosion can be prevented by using appropriate materials of construction. Pressure indicators and alarms can alert operators to possible overpressure in piping. Weld failure can be safeguarded with routine inspections and maintenance.

6.2.7 Storage Tanks

The primary failure modes for storage tanks are loss of containment and static generation, which may result in fires or explosions. Loss of containment is caused by overfilling or overpressure of the tank. This can be prevented with level alarms and overflow lines to secondary containment. Loss of containment of small solids, such as the dry batter mix, creates a risk of a dust explosion occurring. Flammable liquid releases may cause pool fires or jet fires. Static generation can be prevented by grounding or inerting storage tanks.

6.2.8 Deep Fryer

The primary safety concern around the deep fryer is worker proximity to high temperature frying oil. Common equipment failures of industrial fryers are due to temperature indicator failure, resulting in overheating of oil, flameouts of the fryer burners, and buildup of grease or food particles. Routine cleaning and maintenance of the fryer can reduce the risk of failure. The planned operating schedule allows for cleaning every 4 days, which will prevent food particle buildup.

6.3 Environmental Concerns, Inherently Safer Design

The primary food grade product restricts the number of chemicals viable for this process. Additionally, no airborne pollutants are released from the operations of the process. That being said, several organic solvents used for the extraction of sesame oil and lactic acid are potentially hazardous if released into the environment. Chief among these are the butane wash used in the seed oil extraction and the trioctylamine used in the lactic acid reactive extraction. Butane contamination risk could be reduced by decreasing the batch size of seed oil extraction processes; however, this could result in increased labor costs for an identical product output. The volatility of the butane used can be a potential risk for a BLEVE event. Hexane was considered as an inherently safer design, but the increased separation difficulty from the sesame oil rendered this a more dangerous product for consumer health. Butanol has been considered as an inherently safer design for the lactic acid extraction, but the butanol entrainment within the water during these processes is much higher, facilitating the need for some form of butanol recovery system. This was deemed too energy intensive for realistic usage.

On the energy side, unit operations were chosen to reduce the active power consumption, and as a result, energy efficiency is not deemed a significant environmental concern. To improve the efficiency, heat integration was provided for some of the sesame block units.

There is a small concern; however, of the direct carbon dioxide emissions that come from the fermentations and acid neutralizations. Approximately 769,000 pounds of carbon dioxide are vented to the atmosphere each year by the process, which is equivalent to the carbon dioxide released by approximately 76 passenger cars in a year (US EPA, 2016). While this is not as significant as other industrial processes, reduction in the amount released could reduce the impact that the plant has on climate change.

6.4 Waste Management

Edible waste management is one component of this process. Much of the food waste in America is generated during the manufacturing process or distribution. It is expected that the majority of this waste would come from start-up and shut-down operations, as these are non-steady state. To mitigate economic losses and environmental concerns, edible waste will be sold at a low price to local farmers for use as animal feedstock or fertilizer.

In block 1, there are a few instances of non-hazardous waste. The first production of waste is the impurities removed from the hull-on sesame seeds (S1.02). This can include damaged or underdeveloped seeds along with things that may have ended up with the seeds like twigs and small stones. The second instance of non-hazardous waste is the hulls that are removed from the sesame seeds (S1.11). This may not seem like edible waste, however, according to a European study the hulls can be used in broiler chicken feedstock. Sesame seed hulls can only comprise 10% of the broiler chicken feedstock (Nikolakakis et al., 2013), meaning it is possible the demand for the waste is so low that hulls will need to be donated rather than sold to farmers, so the income from the hull waste is negligible.

If the lye waste streams (S1.05 & S1.09) were disposed of as hazardous waste, the disposal cost would be over \$19,000 each year. A negligible amount of the waste in S1.05 is used to neutralize the acidic waste stream in block 2, yet this leaves 99.2% of the stream to be disposed of. In order to render the streams as non-hazardous waste, the streams are combined with each other and 96% sulfuric acid (sulfuric acid concentration: 18.11M). In order to neutralize the solution 96,900 L/year H_2SO_4 must be added to the combined waste streams. This results in a concentration low enough of sodium sulfate that it will be fully dissolved in the

stream, and in a nonhazardous quantity (National Center for Biotechnology Information), meaning this neutralization eliminates the production of hazardous waste from block 1.

Block 2 has several solid and liquid waste systems. In the lactic acid recovery configuration, the three main waste streams are ultrafiltration solids waste, aqueous extraction waste and waste steam from the concentration of lactic acid solution. The steam is the easiest to dispose of and is used as a heating element in other sections of the factory. The solids waste from ultrafiltration is an acidic solution containing large percentages of organic matter. This is disposed of as hazardous solids waste. Because the primary hazard is the acidity, it could be neutralized and sold as animal feed as a minor cost saving implement. Lastly, the aqueous waste from the extraction contains small amounts of organic solvent within it. This includes both octanol and trioctylamine. TOA is hazardous to the environment and requires wastewater processing to be removed. Means to improve these waste disposal methods were considered such as: recombination of solids into aqueous waste to reduce solids disposal costs, TOA scrubbing from wastewater, and evaporation of extraction waste to generate steam heating. It was determined that these measures would not offset the negative profit of lactic acid recovery procedures. When the lactic acid recovery system is removed, the waste disposal system becomes more straightforward. Supernatant from the centrifuge is neutralized with the basic waste from the lye soaking in block 1 and disposed of as nonhazardous wastewater. This waste stream is mostly water with non hazardous salts such as sodium chloride from neutralization, low molecular weight macromolecules, and minor salts from fermentation.

The waste streams of block 3 are the supernatant from the first centrifugation, and the cell debris sludge from the second centrifugation. The supernatant from the first centrifugation contains 97% water, 3% excess molasses components, and less than 1% ethanol. The excess

molasses components are mostly minerals not consumed in the fermentation, and include calcium, magnesium, sodium, potassium, sulfates, phosphates, nitrates, and chlorides, none of which are considered hazardous. Ethanol is easily metabolized in low concentrations by bacteria and therefore its hazard in the waste stream is manageable and acceptable without treatment. Because of this, the supernatant from the centrifuge can be disposed of as wastewater, without requiring any treatment (Peters et al., 2003).

The waste stream from the second centrifugation contains approximately 51% yeast solids, 49% water, and less than 1% ethanol and excess molasses components. Because this waste stream contains no significantly hazardous components, it can be treated as non-hazardous waste and sent to landfill.

The fourth block contains one waste stream around the deep fryer and de-oiling screen. This stream is made up of primarily used frying oil with trace amounts of breading/solids. Frying oil can be treated as non-hazardous waste but must be cooled and stored before disposal.

6.5 Social Considerations

The chosen location for this manufacturing plant is the Coastal Bend region of Texas because of proximity to raw materials and the cost of state industrial expenses. This region also provides access to a constant water supply from Lake Corpus Christi and plentiful groundwater (TWDP, 2021). The installation of this plant will generate a number of jobs in the area, for both operators and construction or contracting companies.

Good manufacturing practices (GMP) are crucial in the food manufacturing industry. Since the proposed product is an alternative to soy protein, it is necessary to eliminate any possible cross contamination. This can be done by ensuring no soy products enter the plant. Sanitation and quality assurance are important in making a trustworthy product and building brand support. A major component of this is using food grade materials in construction of unit operations, and providing sterilization procedures between batch fermentations. Another concern is contamination or foreign objects in contact with the final edible products. The most efficient way to ensure no foreign objects are present in the products is to implement metal detection throughout the process. Common industry practices such as preventing employees from wearing jewelry can reduce the risk of product contamination. Strict guidelines on personal hygiene, detailed documentation, and product labeling are also crucial components of GMP.

Other considerations relating to this project are federal regulations on food products. Costs associated with development of a new food product were considered out of scope of this report. One component of this is labeling of food products for nutritional information and allergens. The FDA oversees safety of chemicals in food products and that come in contact with food products. As detailed in section 6.1, a number of chemicals are used throughout this

process; none of these are present in hazardous amounts in either final food product, but care should be taken to prevent contamination.

SECTION 7: CONCLUSION AND RECOMMENDATIONS

7.1 Go/No Go Decision

The designed process produces two final products, sesame oil and plant-based chicken nuggets, and includes 3 primary blocks; seed oil extraction, seed cake fermentation, and final mixing. Purification of the lactic acid in the supernatant of the sesame cake fermentation was considered to sell lactic acid as a side product, but raw material costs rendered this process unprofitable. In the final mixing stage, the fermented seed cake, along with flavoring and binding agents, gets combined, formed, breaded, battered, and fried to create the final product. In the initial designs, a block to generate yeast extract, used as a flavoring agent in the final nugget, was considered, but the costs were much greater than purchasing yeast extract as a raw material.

By removing the less efficient sectors of the process (block 3 and the lactic acid recovery steps in block 2) and purchasing these ingredients directly, a significant internal rate of return of 64.6% can be achieved. This can offset the significant risk involved with the product. If the proper market studies can prove demand for sesame specific nuggets, this can be a highly profitable venture that should be pursued. An additional aspect to consider is the volatility of the plant based meat market itself. Due to the current status of plant based meats as a luxury good, economic downturns could present significant issues with selling all of the nuggets produced. Due to the inability to significantly reduce product pricing at this scale, a consumer elasticity study or studying direct to consumer options may also be worthwhile investigations. Both material costs and operator wages represent significant expenses. As a result, making deals with suppliers or increasing automation could reduce operational costs and improve long term profitability.

7.2 Future Work

Further development of the nugget recipe is needed to improve flavor and texture before implementation of this process. There are opportunities for future improvements in all of the process blocks. The first of these improvements is in the separation procedures for lactic acid purification. The primary reason for its lack of profitability was due to the low concentration in the starter stream. The starter concentration had to be low because entrainment of the lactic acid within the pellet during centrifugation is a potent flavor contaminant and this separation was lower yield than some of the other procedures further downstream. If this starting step can achieve more precise separation, the fermentation could safely produce more lactic acid, and therefore more could be recovered in the end phase.

Future improvements could also be made to the yeast extract block. A significant amount of cost went into the molasses feed, which could be reduced if the fermentation was better optimized at a larger scale. To do so, further study could determine how the aerobic fermentation scales. Additionally, there was a large cost associated with the equipment for block 3, a majority of which come from the fermenters. If the fermentation is optimized, there is potential to eliminate some of the fermenters and reduce cost.

The final mixing block also has areas for improvement. The theoretical frying oil turnover rate in block 4 is much higher than industry average (around 20 hours compared to the typical 5-10 hours). Future work should focus on reducing this value because a high oil turnover rate correlates with increased oil degradation and decreased product shelf life. A lower frying oil turnover rate could not be accomplished due to the fryer capacity and target production rates of the vegan nuggets. This value was optimized for this project to ensure sufficient oil was held in the fryer for the volume of nuggets being added. A more efficient fryer or using multiple smaller

deep fryers may help in reducing this value. The recipe used to formulate the nuggets could also be improved upon to reduce raw material costs. Ensuring that the majority of product weight losses during processing are due to water evaporation can improve the flavor and reduce losses of higher value raw materials.

7.3 Acknowledgement

We would like to thank several individuals who made this thesis possible. Eric Anderson helped during many capstone meetings to answer questions and offer guidance. Kevin London provided significant aid for centrifugation and ultrafiltration design.

SECTION 8: TABLE OF NOMENCLATURE

Sample units should be shown

Abbreviation	Meaning
°C	Degrees Celsius
MM	Million
rad/s	Radians per Second
RPM	Revolutions Per Minute
Pas	Pascal Seconds
TOA	Triethylamine
HPMC	Hydroxypropyl Methylcellulose
lbs	Pounds (mass)
kg	Kilograms
m	Meters
(k)J	(kilo)joules
(k)W	(kilo)watts
GPM	Gallons Per Minute
(k)Da	(kilo)Dalton

SECTION 9: REFERENCES

- ALSCO (n.d.). Armstrong TANK FLASH HAFT-2448 Carbon Steel Flash Tanks, Horizontal, 150 lb ASME D47467. A Louis Supply Company.
alouissupply.com/Steam-and-Filter-Products/Armstrong-Z16728/501-D47467/Armstrong-TANK-FLASH-HAFT-2448-Carbon-Steel-Flash-Tank-Horizontal-150lb-ASME-D47467
- Alibaba. (n.d.-a). Industry Cocoa Bean Sesame Seed Roasting 500 Kg Korea Sesame Roaster Machine Peanut Roasting Small Size.
www.alibaba.com/product-detail/Industry-Cocoa-Bean-Sesame-Seed-Roasting_1600254242520.html
- Alibaba. (n.d.-b). Flexible Screw Conveyor/Mini Powder Screw Feeder For Flour.
www.alibaba.com/product-detail/Flexible-screw-conveyor-mini-powder-screw_62129021219.html
- Alibaba. (n.d.-c). High Efficiency Tunnel Freezer For SeaFood Quick Freezing Stainless Steel316 Iqf Tunnel.
www.alibaba.com/product-detail/High-Efficiency-Tunnel-Freezer-For-SeaFood_1600502255910.html
- Alibaba. (n.d.-d). Stainless Steel Small Mini Portable Corn Maize Flour Storage 1 Ton Grain Silo.
www.alibaba.com/product-detail/Good-Price-Stainless-Steel-Small-Mini_1600828063337.html
- Alibaba. (n.d.-e). 3 ton grain bin for sale.
www.alibaba.com/product-detail/3-ton-grain-bin-for-sale_1600490217353.html
- Alibaba. (n.d.-f). Solid Liquid Separation Sedimentation Tank Primary and Secondary Settling Lamella Clarifier.
www.alibaba.com/product-detail/solid-liquid-separation-sedimentation-tank-primary_1600458990828.html
- Alliance Chemical. (n.d.). Hydrochloric Acid 37% ACS Reagent Grade.
alliancechemical.com/product/hydrochloric-acid-37/
- Alonso, A. (1998). Modeling and Adaptive Control for Batch Sterilization.
www.sciencedirect.com/science/article/abs/pii/S0098135497002500
- Artis Micropia. (n.d.). Yeast. www.micropia.nl/en/discover/microbiology/yeast/

- ASHRAE. (2006). Thermal Properties of Foods.
www.worldcool.co.th/images/Knowledge/13-Unfrozen-Composition-Data.PDF
- Ankur. (2016). Solid-Liquid Mixing in Agitated Vessels (Just Suspended Speed).
 CHEresources.com.
www.cheresources.com/invision/blog/4/entry-511-solid-liquid-mixing-in-agitated-vessels-just-suspended-speed/
- Ashtiana, S. H. M., Emadi, B., Sanaei-Moghadam, A., & Aghkhani, M. H. (2014). Effect of moisture content and temperature on thermal behavior of sesame seed. *Annals of the University Dunarea de Jos of Galati Fascicle VI – Food Technology*, 38(1), 87-103.
- Bailun Biotechnology. (n.d.). Industrial Fermentation Fermenter Price Bioreactor.
bailunbio.en.made-in-china.com/product/NdpTtHqrbMUh/China-Industrial-Fermentation-Fermenter-Price-Bioreactor-100L.html
- BagCorp. (n.d.). 48" x 48" x 48" (H) Bulk Master Super Sack Container.
bagcorp.com/products/super-sack-plus-99999-66?variant=29394837176384
- Baoding Chuangrui Precision Pump Co. (n.d.). OEM210/WP500 High Flow DC water Pump
 12V Peristaltic Pump for Milk Vending
www.alibaba.com/product-detail/Manufacturer-Peristaltic-Pump-OEM210-WP500-High_60469054748.html
- Bestsort Technology. (n.d.). 5XFZ-25 Air Screen Cleaner with Gravity Table.
bestsorttechnology.com/product/5xfz-25-air-screen-cleaner-with-gravity-table/
- Bhuiyan, M. H. R., & Ngadi, M. O. (2023, Dec. 13). Impact of batter solid-water ratio and frying time on meat-analog based coated fried food. *LWT - Food Science and Technology*, 191. doi.org/10.1016/j.lwt.2023.115647
- Bulk Apothecary (n.d.). Canola Oil. www.bulkapothecary.com/canola-oil/
- Bulk Supplements (n.d.). Hydroxypropyl Methylcellulose Powder.
www.bulksupplements.com/products/hypromellose-powder
- Burdock, G. A. (2007). Safety assessment of hydroxypropyl methylcellulose as a food ingredient. *Food and chemical toxicology : an international journal published for the British Industrial Biological Research Association*, 45(12), 2341–2351. doi.org/10.1016/j.fct.2007.07.011

- C1D1 Labs, C. (2023, June 11). Hydrocarbon Bag Filters. *C1D1 Labs*.
c1d1labs.org/hydrocarbon-bag-filters/
- Caframo Lab Solutions. (2016). 7 Factors for Selecting a Stirring Impeller.
www.caframolabsolutions.com/application/dissolving/7-factors-select-impeller/
- Carbonell-Barrachina, Á., Lluch, M., Pérez-Munera, I., Hernando, I., Castillo, S. (2009). Effects of Chemical Dehulling of Sesame on Color and Microstructure. *Food Science and Technology International*, 15(3), 229-234. doi.org/10.1177/1082013208339704
- Cedar Stone Industry. (n.d.). 30 Gallon mixing tank.
cedarstoneindustry.com/product/30-gallon-mixing-tank/
- Chemical Book. (n.d.-a). Methyl cellulose.
www.chemicalbook.com/ChemicalProductProperty_EN_CB3474718.htm
- Chemical Book. (n.d.-b). 8008-74-0(Sesame Oil) Product Description.
www.chemicalbook.com/ChemicalProductProperty_US_CB6125673.aspx
- Chemical Features of Water. (1987, March). 4. dissolved oxygen.
www.fao.org/3/AC183E/AC183E04.htm
- Chemical Land. (n.d.). TRIOCTYLAMINE (N,N-DIOCTYL-1-OCTANAMINE).
hwww.chemicaland21.com/industrialchem/organic/TRIOCTYLAMINE.htm
- Chonry Peristaltic Pump. (n.d.). Industrial Filling Peristaltic Pump for Production Line—BG600FJ-S/YZ35-13.
www.crpumpshop.com/Industrial-Filling-Peristaltic-Pump-BG600FJ-SYZ35-13-p3096516.html
- CQ Concepts. (n.d.). Sodium carbonate - Bulk 2450 pound pallet.
cqconcepts.com/product/sodium-carbonate-bulk-2450-pound-pallet/
- Cravotto, C., Fabiano-Tixier, A., Claux, O., Abert-Vian, M., Tabasso, S., Cravotto, G., & Chemat, F. (2022). Towards Substitution of Hexane as Extraction Solvent of Food Products and Ingredients with No Regrets. *Foods*, 11(21), 3412.
doi.org/10.3390/foods11213412
- Darvishi, H. (2012). Moisture-Dependent Physical and Mechanical Properties of White Sesame Seed. *American-Eurasian J. Agric. & Environ. Sci.*, 12 (2): 198-203.

- Dipak, D., Quensel, E., & Hansen, R., (1986). Nitrogen Extractability and buffer capacity of defatted linseed (*linum usitatissimum* L.) flour. *Journal of the Science of Food and Agriculture*, 2(37), 199-205. doi.org/10.1002/jsfa.2740370215
- DK Tank & Pipe. (n.d.) 3,000 Gallon- 316L Stainless Steel Tank SKU407.
www.dktanks.com/product-page/3-000-gallon-316l-stainless-steel-tank
- Dodo, M. R., Dauda, E. T., & Adamu, M. A. (2016). Investigating the cooling rate of cane molasses as quenching medium for 0.61% C high carbon steels. *Metallurgical and Materials Engineering*, 22(1), 39–50. doi.org/10.30544/139
- Donjoy Technology Co (n.d.). DONJOY food grade centrifugal pump stainless steel electric centrifugal pump hygienic centrifugal pump water pump for beverage.
www.alibaba.com/product-detail/DONJOY-food-grade-centrifugal-pump-stainless_1600259883348.html
- Dynamix Agitators. (2015, March 10). Mixing 101: Optimal Tank Design.
dynamixinc.com/optimal-tank-design/
- EChemi (n.d.). 1-Octanol international price.
www.echemi.com/pip/1-octanol-pid_Seven1284.html
- EIA (2023, June 29). U.S. Energy Information Administration. Electricity explained.
www.eia.gov/energyexplained/electricity/prices-and-factors-affecting-prices.php
- EIA. (2024, January). U.S. Energy Information Administration. *Natural Gas Industrial Price*.
www.eia.gov/dnav/ng/ng_pri_sum_a_epg0_pin_dmcf_m.htm
- Elkhaleefa, A., & Shigidi, I. (2015). Optimization of sesame oil extraction process conditions. *Advances in Chemical Engineering and Science*, 05(03), 305–310.
doi.org/10.4236/aces.2015.53031
- Engineering ToolBox. (n.d.). Convective Heat Transfer.
www.engineeringtoolbox.com/convective-heat-transfer-d_430.html
- Engineering ToolBox. (2003). Food and Foodstuff - Specific Heat.
www.engineeringtoolbox.com/specific-heat-capacity-food-d_295.html
- Engineering Toolbox. (2004a). Water - Dynamic (Absolute) and Kinematic Viscosity vs. Temperature and Pressure.
www.engineeringtoolbox.com/water-dynamic-kinematic-viscosity-d_596.html

- Engineering Toolbox. (2004b). Water - specific heat vs. temperature.
www.engineeringtoolbox.com/specific-heat-capacity-water-d_660.html
- Engineering Toolbox. (2004c). Liquids - densities.
www.engineeringtoolbox.com/liquids-densities-d_743.html
- Engineering ToolBox (2010). Densities of common Products.
www.engineeringtoolbox.com/density-materials-d_1652.html
- EZ-Vap (n.d.) EZ-Vap Wastewater Evaporator Pricing. www.ez-vap.com/evaporator-pricing
- Fasina, O. O., & Colley, Z. (2008, Nov. 17). Viscosity and specific heat of vegetable oils as a function of temperature: 35°C to 180°C. *International Journal of Food Properties*, 11(4), 738-746. doi.org/10.1080/10942910701586273
- Felder, R., Rousseau, R., & Bullard, L. (2016). *Elementary Principles of Chemical Processes* (Fourth edition) John Wiley and Sons inc.
- Figueredo, C., Rejon, O., Negrete, A., Volquart, A., Giron, F., & Partida, J. (2021). Kinetic Parameters of *Lactobacillus Plantarum* and *Saccharomyces Boulardii* growing in a beet molasses culture media. *Journal of Mexican Chemical Engineering*, 20(1) 467-478. doi.org/10.24275/rmiq/Bio2002
- Food and Drug Administration. (2024, March. 1) Code of Federal Regulations Title 21.
www.accessdata.fda.gov/scripts/cdrh/cfdocs/cfcfr/CFRSearch.cfm
- Fujii, T. (2017). Coagulation and Rheological Properties of Soy Milk Colloidal Dispersions. *Food Engineering Science*, 81(4), 680-686. doi.org/10.1080/09168451.2017.1282810
- Gelgoog Company. (n.d.). Commercial sesame seed cleaning production line.
www.peanutbuttere.com/line/sesame-seed-cleaning-line.html
- Glacier Tanks. (n.d.-a). 150 Gallon Mixing Tank | Stainless Steel.
www.glaciertanks.com/tanks-mixing-tanks-mx-150-galhtml
- Glacier Tanks. (n.d.-b). 1000 Gallon Mixing Tank | Stainless Steel.
www.glaciertanks.com/tanks-mixing-tanks-mx-1000-galhtml
- Gojiya, D., & Gohil, V. (2022). Design and development of low cost sesame dehuller and its process standardization. *Journal of Food Science and Technology*, 59, 1–11. doi.org/10.1007/s13197-022-05524-y

- Grainger. (n.d.-a). 240,000 BtuH Water Heat Dissipation, 12 gpm, Heat Exchanger.
www.grainger.com/product/STANDARD-XCHANGE-Heat-Exchanger-240-5TNW4
- Grainger. (n.d.-b). Shell/Tube Heat Exchanger: 2,300,00 BtuH Water Heat Dissipation, Copper Tube.
www.grainger.com/product/STANDARD-XCHANGE-Shell-Tube-Heat-Exchanger-810RGO
- Green, D. W., & Southard, M. Z. (Eds.). (2019). *Perry's chemical engineers' handbook* (Ninth edition, 85th anniversary edition). McGraw Hill Education.
- GoFoodService. (2024). Commercial Deep Fryer Maintenance Checklist.
www.gofoodservice.com/blog/6-important-maintenance-tips-for-your-restaurant-deep-fryer
- Güngör, U. (2024). *Design of a new equipment for sesame seed dehulling*. The Middle East Technical University. etd.lib.metu.edu.tr/upload/2/678/index.pdf
- GW Kent. (n.d.). Mixing / Blending Tank 3000 L. (793 gal).
www.gwkent.com/mixing-blending-tank-1000-l-265-gal-2.html
- He, S., Pan, T., Zhang, Z., Wu, Y., Sun, H., Ma, Y., & Zhang, Y. (2023). Interactive effect of hot air roasting processes on the sensory property, allergenicity, and oil extraction of sesame (*Sesamum indicum* L.) seeds. *Grain & Oil Science and Technology*, 6(2), 71–81.
doi.org/10.1016/j.gaost.2023.02.001
- Henderson, J. (1962). Selection of screens for cleaning seed. *Proceedings of the Short Course for Seedsmen*, 96. scholarsjunction.msstate.edu/seedsmen-short-course/96
- Henen Kelefu Equipment Technology Co. (n.d.). Automatic screw press machine for food waste sludge dewatering.
www.alibaba.com/product-detail/Automatic-dewatering-screw-press-machine-for_1600847233996.html
- Hephis Aqua Tech (fujian) Co. (n.d.). Factory Outlet 6.5-150L/hr Mechanical Diaphragm Metering Pump for Alkali Acid Chemicals Dosing Pump High Quality Best Price.
www.alibaba.com/product-detail/Factory-Outlet-6-5-150L-hr_1601038777226.html
- Heritage Equipment. (n.d.). Stainless Steel Mixing Tanks & Blending Tanks.
www.heritage-equipment.com/stainless-steel-tanks/mixing-tanks.html

- Hogg, E., & Rauh, C. (2023). Towards a Better Understanding of Texturization during High-Moisture Extrusion (HME)—Part II: Characterization of Thermophysical Properties of High-Moisture Meat Analogues. *Foods*, *12*(12), 2283. doi.org/10.3390/foods12122283
- Impossible Foods. (n.d.). Impossible™ chicken nuggets made from plants, 13.5 oz. impossiblefoods.com/products/chicken/frozen-nuggets
- INDCO. (n.d.-a) 150-Gallon Stainless Steel Mixing Tank.
www.indco.com/shop/product/sst-150/150-gallon-stainless-steel-mixing-tank
- INDCO. (n.d.-b). 300-Gallon Stainless Steel Mixing Tank.
www.indco.com/shop/product/sst-300/300-gallon-stainless-steel-mixing-tank
- Index Box (2024). Sesame seed price in the United States - 2023.
www.indexbox.io/search/sesame-seed-price-the-united-states/
- Jiangsu Xuyang Chemical Equipment Co (n.d.) 100L Continuous Stirred Tank Reactor Batch Jacketed Stainless Steel Chemical Reactor.
jiangsuxuyang.en.made-in-china.com/product/zwsxijhyLpcg/China-100L-Continuous-Stirred-Tank-Reactor-Batch-Jacketed-Stainless-Steel-Chemical-Reactor.html
- Jones, T., *Advances in Slurry Technology*. London: Intechopen. 2023
- Julite. (n.d.). 5XFZ-25s Air Screen Cleaner with Gravity Table and 5xfj-10C Vibration Grader.
www.julite.com/Case_info/id/135.html
- Kandpal, L., Lee, H., Kim, M., Mo, C., & Cho, B.-K. (2013). Hyperspectral Reflectance Imaging Technique for Visualization of Moisture Distribution in Cooked Chicken Breast. *Sensors*, *13*(10), 13289–13300. doi.org/10.3390/s131013289
- Khalfallah, R., Mechmeche, M., Jmoui, I., Ksontini, H., Hamdi, M., & Kachouri, F. (2022). Growth Kinetics of *Lactobacillus plantarum* in Sesame Seed Protein Extract Media. *Chemistry Africa*, 1–10. www.doi.org/10.1007/s42250-022-00573-4
- Komesu, A., Fazzio P., Martinez, M., Hoss-Lunelli, B., Oliveira, J., Maciel, R., Filho, R. (2017). Study of lactic acid thermal behavior using thermoanalytical techniques. *Journal of Chemistry*, 2017. doi.org/10.1155/2017/4149592
- Kumar, S., Yadav, N., Nain, L., & Khare, S. K. (2020). A simple downstream processing protocol for the recovery of lactic acid from the fermentation broth. *Bioresource Technology*, *318*, 124260. www.doi.org/10.1016/j.biortech.2020.124260

Kuriyama, H., & Kobayashi, H. (2003, March 21). Effects of oxygen supply on yeast growth and metabolism in continuous fermentation. *Journal of Fermentation and Bioengineering*, 75(5). 364-367. doi.org/10.1016/0922-338X(93)90135-U

Lab Alley. (n.d.). Sulfuric Acid ACS Grade.
www.laballey.com/products/sulfuric-acid-accs-grade?variant=40875821269147

Lab 1st. (n.d.). USA Inventory Peristaltic Pump 0.0001-720ml/min Flow Range, 0.1-150 rpm.
eshop.lab1st.com/products/peristaltic-pump-0-0001-720ml-min-flow-range-0-1-150-rpm-ac100-240v

Lan, K., Xu, S., Li, J., & Hu, C., (2019, June 30). Recovery of Lactic Acid From Corn Stover Hemicellulose-Derived Liquor. *ACS Omega*, 4(6), 10571-10579.
doi.org/10.1021/acsomega.9b00794

Lang, B. (2012). Solubility of Water in 1-Octanol from 2 °C to 96 °C, *Journal of Chemical and Engineering Data*

Level 7 Chemical (n.d.). Caustic Soda Beads (Bags).
level7chemical.com/chemicals/caustic-soda-bag

Liaoning Fuyi Machinery Co (n.d.) High Performance 3 phased diesel fuel oil and fuel oil separator food grade stainless steel disc centrifuge.
www.alibaba.com/product-detail/High-performance-3-phase-diesel-oil_1600958869074.html

Lin, D. (2023, March 13). Vibration Sieving Machines - Accurate Batch Grading, Safe Screening of Powders and Liquids.

Lin, D (2023, March 13). Vibration Sieving Machines– Accurate Batch Grading, Safe Screening of Powders and Liquids.
www.linkedin.com/pulse/vibrating-sieving-machines-accurate-batch-grading-safe-da-lin/

Made-in-China. (n.d.-a). Vegetarian Chicken Analog Food Meat Tvp Nuggets Extruder Making Machine.
kelidmachine.en.made-in-china.com/product/LSmnEZcYHORv/China-Vegetarian-Chicken-Analog-Food-Meat-Tvp-Nuggets-Extruder-Making-Machine.html

Made-in-China.(n.d.-b). Automatic Chicken Burger Patty Meat Pie Nugget Battering Breeding Machine for Sale.
verfoodsolutions.en.made-in-china.com/product/yJYrpwKUORUu/China-Hot-Sale-Automatic-Chicken-Burger-Patty-Meat-Pie-Nugget-Battering-Breeding-Machine-for-Sale.html

- Made-in-China. (n.d.-c). Continuous Deep Fryer for Fried Chicken Nuggets Frying Machine.
zhuchengtianshun.en.made-in-china.com/product/HFeArWRUvfpg/China-Continuous-Deep-Fryer-for-Fried-Chicken-Nuggets-Frying-Machine.html
- Made-in-China. (n.d.-d). Stainless Steel Linear Vibrating Screen for Food Particle Grading.
xinxiangcobrotech.en.made-in-china.com/product/UEcYuaJOOWVK/China-Stainless-Steel-Linear-Vibrating-Screen-for-Food-Particle-Grading.html
- Made-in-China. (n.d.-e). Cooling Tunnel for Chocolate Production.
gusumachinery.en.made-in-china.com/product/GskQugPEIWA/China-Short-Lead-Time-Cooling-Tunnel-for-Chocolate-Production.html
- Maisuria, J., & Hossian, M. (2007, March 29). Equilibrium studies of the extraction and re-extraction of lactic acid. *Journal of Chemical and Engineering Data*, 52(3), 665-670.
doi.org/10.1021/je060051x
- McMaster Carr. (n.d.) 30 gallon Stainless Steel Easy Drain Tank.
www.mcmaster.com/products/tanks/capacity~30-gal/?s=stainless-steel-tanks
- Medium. (2023). Sulfuric Acid Price Outlook.
medium.com/intratec-products-blog/sulfuric-acid-prices-latest-historical-data-in-several-countries-e9a36c4867cb
- Mini Oil Mills. (n.d.). Sesame Oil Expeller - sesame oil press machine manufacturer from Rajkot. www.minioilmills.com/sesame-oil-expeller.html
- Misailidis, N. & Petrides, D. (2020, Aug.). Yeast extract production - process modeling and techno-economic assessment (TEA) using SuperPro Designer.
10.13140/RG.2.2.27312.58882
- Misljenovic, N., Schuller, R.B., Rukke, E., & Salas-Bringas, C. (2013). Rheological characterization of liquid raw materials for solid biofuel production. *Annual Transaction of the Nordic Rheology Society*, 21, 61-68.
- Moharram, Y.G., Osman, H.O.A., Abou-El-Khier, Y.I.A. (1984). Wet Decortication of Sesame Seeds by New Methods. *Food and Nutrition Bulletin*, 12(1), 1-6.
[doi:10.1177/156482659001200126](https://doi.org/10.1177/156482659001200126)
- Moore, M. (2009). Why Rotary Positive Displacement Screw Pumps Are an Efficient Pumping Solution Over Time.
www.pumppower.com.au/wp-content/uploads/2017/06/PumpSystems.pdf

- Morningstar Farms. (n.d.) Morningstar Farms® veggie chik'n nuggets.
www.morningstarfarms.com/en_US/products/chikn/morningstar-farms-chik-n-nuggets-product.html
- MSE Supplies. (n.d.). MSE PRO Intelligent Flow Type Peristaltic Pump.
www.msesupplies.com/products/mse-pro-intelligent-flow-type-peristaltic-pump
- Mukhtar, K., Asgher, M., Afghan, S., Hussain, K., & Zia-ul-Hussnain, S. (2010). Comparative Study on Two Commercial Strains of *Saccharomyces cerevisiae* for Optimum Ethanol Production on Industrial Scale. *Journal of Biomedicine and Biotechnology*, 2010, 419586. doi.org/10.1155/2010/419586
- MyKin. (n.d.). Rubber Chemical Resistance Chart. mykin.com/rubber-chemical-resistance-chart
- My Spice Sage. (n.d.). Fried Chicken Seasoning.
www.myspicesage.com/products/fried-chicken-seasoning
- National Center for Biotechnology Information. PubChem Compound Summary for CID 24436, Sodium sulfate. pubchem.ncbi.nlm.nih.gov/compound/Sodium-sulfate
- National Tank Outlet. (n.d.-a). 5000 Gallon NORWESCO Black Plastic Vertical Water Storage Tank. www.ntotank.com/5000gallon-norwesco-black-vertical-water-tank-x1750809
- National Tank Outlet. (n.d.-b). 6000 Gallon NORWESCO White Vertical Storage Tank.
www.ntotank.com/6000gallon-norwesco-white-vertical-storage-tank-x3569351
- Nangata, S. *Mixing Principles and Applications*. Tokyo: Kodansha LTD. 1975
- Nanjing Fivemen Machine. (n.d.). High Speed Self-Cleaning Beer Yeast Disc Stack Centrifuge Separator Machine Price..
fivemen.en.made-in-china.com/product/EFhJZnVdZRWk/China-High-Speed-Self-Cleaning-Beer-Yeast-Disc-Stack-Centrifuge-Separator-Machine-Price.html
- National Tank Outlet. (n.d.-a). 850 Gallon Norwesco white vertical storage tank.
www.ntotank.com/850gallon-norwesco-white-vertical-storage-tank-x3984405
- National Tank Outlet. (n.d.-b). 2500 Gallon Ace roto-mold cone bottom tank.
www.ntotank.com/2500gallon-acerotomold-white-cone-bottom-tank-x6047324
- Nayak, A. P., & Sethi, S.N. (2022). Bio-processing of low-cost sesame oil cake for nutritional enhancement of carp diet. *E-planet*, 20(2). 121-128.
- Nex Flow. (2020, January 17). How to easily Calculate the Cost of your Compressed Air. *Nex Flow Air Products Corp*. www.nexflow.com/blog/easily-calculate-cost-compressed-air/

- Nikolakakis, I., Bonos, E., Kasapidou, E., Kargopoulos, A., & Mitlianga, P. (2013, August 5). Effect of dietary sesame seed hulls on broiler performance, carcass traits and lipid oxidation of the meat - European Poultry Science. *European Poultry Science (EPS)*. www.european-poultry-science.com/effect-of-dietary-sesame-seed-hulls-on-broiler-performance-carcass-traits-and-lipid-oxidation-of-the-meat,
- NJ Health. (2015). Hazardous Substance Fact Sheet: Sodium Hydroxide. *New Jersey Department of Health*. nj.gov/health/eoh/rtkweb/documents/fs/1706.pdf
- NJ Health. (2016). Hazardous Substance Fact Sheet: Sulfuric Acid. *New Jersey Department of Health*. nj.gov/health/eoh/rtkweb/documents/fs/1761.pdf
- NOAA. (2022). OCTANOL. CAMEO Chemical. cameochemicals.noaa.gov/chemical/8916
- OSHA. (2020, December 18). *BUTANE*. Occupational Safety and Health Administration. www.osha.gov/chemicaldata/49
- OSHA. (2021a, January 12). SODIUM HYDROXIDE. Occupational Safety and Health Administration. www.osha.gov/chemicaldata/211
- OSHA. (2021b, January 12). SULFURIC ACID. Occupational Safety and Health Administration. www.osha.gov/chemicaldata/624
- OSHA. (2022, June 2). CARBON DIOXIDE. www.osha.gov/chemicaldata/183
- OSHA. (2023, June 14). ETHYL ALCOHOL (ETHANOL). Occupational Safety and Health Administration. www.osha.gov/chemicaldata/1034
- OSHA. (2024, March 25). HYDROGEN CHLORIDE. Occupational Safety and Health Administration. www.osha.gov/chemicaldata/620
- Pang, J., Guan, E., Yang, Y., Li, M., Bian, K., (2021, July 16). Effects of wheat flour particle size on flour physiochemical properties and steamed bread quality. *Food Science and Nutrition*, 9(9). 4691-4700. doi.org/10.1002/fsn3.2008
- Palmonari, A., Cavallini, D., Sniffen, C. J., Fernandes, L., Holder, P., Fagioli, L., Fusaro, I., Biagi, G., Formigoni, A., & Mammi, L. (2020). Short communication: Characterization of molasses chemical composition. *Journal of dairy science*, 103(7), 6244–6249. doi.org/10.3168/jds.2019-17644
- Perry Biehler. (n.d.). 800 liters stainless steel mixing tank, cylindrical, vertical. biehler-equip.com/gb/mixing-tanks/2545-800-liters-stainless-steel-mixing-tank-cylindrical-vertical.html

- Peters, M. S., Timmerhaus, K. D., & West, R. E. (2003). *Plant design and economics for chemical engineers* (5th ed). McGraw-Hill.
- Plastic-Mart. (n.d.). 4000 Gallon Plastic Vertical Water Storage Tank in Green. www.plastic-mart.com/chemtainer-125-inch-wide-4000-gallon-plastic-vertical-water-storage-tank-in-green-tc4001iw-green?
- Pleasant Hill Grain (n.d.) Meadows 12” Standard Mill. pleasanthillgrain.com/meadows-12-standard-mill
- Prater Industries. (n.d.). Rotary sifters (rotary sieves). www.praterindustries.com/products/rotary-sifters/
- Prpich, G. (2023). Aerobic Bioreactor Design Algorithm [Powerpoint Presentation]. Canvas.
- Rogers, E. (2023). Impossible Foods: Growing the Plant-Based Meat Sector at Home and Abroad. *Journal for Global Business and Community*, 14(1). doi.org/10.56020/001c.71493
- Saeed, W. (May, 10, 2014) Estimation of Purchased Equipment Costs. chemicalprojects.wordpress.com/2014/05/10/estimation-of-purchased-equipment-costs/
- Schimek, C., Egger, E., Tauer, C., Striedner, G., Brocard, C., Cserjan-Puschmann, M., & Hahn, R. (2020). Extraction of recombinant periplasmic proteins under industrially relevant process conditions: Selectivity and yield strongly depend on protein titer and methodology. *Biotechnology Progress*, 36(5), e2999. doi.org/10.1002/btpr.2999
- Schmid, E., Farahnaky, A., Adhikari, B., & Torley, P. J. (2022, Sept. 19). High moisture extrusion cooking of meat analogs: A review of mechanisms of protein texturization. *Comprehensive Reviews in Food Science and Food Safety*, 21(6), 4573-4609. doi.org/10.1111/1541-4337.13030
- Schweitzer, P. A. (Ed.). (1979). *Handbook of separation techniques for chemical engineers*. McGraw-Hill.
- Science Facts. (n.d.). Stokes’ Law. www.sciencefacts.net/stokes-law.html
- Seader, Henley and Roper, Separation Process Principles, 3rd ed., 2011, pp. 334-335.
- Seid, F., & Mehari, B. (2022, Dec. 29). Elemental and Proximate Compositions of Sesame Seeds and the Underlying Soil from Tsegede, Ethiopia. *International journal of analytical chemistry*, 1083196. doi.org/10.1155/2022/1083196

- Selina Wamucii. (2024a, March). US Molasses Prices.
www.selinawamucii.com/insights/prices/united-states-of-america/molasses/
- Selina Wamucii. (2024b, March). US Nutritional yeast Prices.
www.selinawamucii.com/insights/prices/united-states-of-america/nutritional-yeast/
- Sigma Aldrich. (2024, March. 1) L-Sodium Lactate Properties.
www.sigmaaldrich.com/US/en/product/sigma/l7022
- Sigma Aldrich (n.d.). Trioctylamine. www.sigmaaldrich.com/US/en/product/aldrich/t81000
- Shandong Tonsen Equipment Co. (n.d.). 10000l 15000l 20000l beer fermenter stainless steel storage tank brewery equipment.
www.alibaba.com/product-detail/10000l-15000l-20000l-beer-fermenter-stainless_1600455016891.html
- Smooth-On. (n.d.). *Viscosity Scale*. Smooth-On, Inc. Retrieved May 6, 2024, from www.smooth-on.com/page/viscosity-scale/
- Sun, Y. & Carrascal, J.R. (2023). Homemade vegan nuggets with texturized soy protein and tempeh as compared to chicken-based ones: Texture, consumer perception and environmental impact. *International Journal of Gastronomy and Food Science*, 33. doi.org/10.1016/j.ijgfs.2023.100748
- Supplyline Industrial. (n.d.-a). 293-29112 | 2100 Gal—Single Wall Value Pak—Silver Pak.
supplyline.com/product/pea/vp/vp1/29329112/
- Supplyline Industrial. (n.d.-b). 293-29113 | 2500 Gal—Single Wall Value Pak—Silver Pak.
supplyline.com/product/pea/vp/vp1/29329113/
- Synder Filtration (n.d.) Industrial Ultrafiltration Spiral-Wound Element.
<https://synderfiltration.com/industrial-ultrafiltration-spiral-wound-element/sm-pes-20kda-industrial/#c>
- Taheri-Garavand, Amin. (2009). Some of nutritional and engineering properties of sesame seed (*Sesamum indicum* L.).
- Tanguler, H., & Erten, H. (2008). Utilization of spent brewer's yeast for yeast extract production by autolysis: The effect of temperature. *Food and Bioproducts Processing*, 86(4), 317–321. doi.org/10.1016/j.fbp.2007.10.015
- TATA Chemicals. (June 15, 2013). Soda Ash (Na₂CO₃) Material Safety Data Sheet.
www.tatachemicals.com/upload/pdf/sbcarbonate_material_safety_data_sheet.pdf

- Texas Water Development Board. (2021, July, 11). Summary of the 2021 Coastal Bend (N) Regional Water Plan. www.twdb.texas.gov/waterplanning/swp/2022
- Thermo Fischer Scientific. (2021, December 24). Lactic Acid SDS. www.fishersci.com/store/msds
- ThermoFisher. (n.d.). Food extrusion in plant-based meat development and production. www.thermofisher.com/us/en/home/materials-science/food-development/applications/plant-based-meat-development.html
- Torang, A. Jonsson, A. Zacchi, G. (Feb 1999). Separation of Cells and Proteins from fermentation broth in a shear-enhanced cross-flow ultrafiltration module as the first step in the refinement of lactic acid. *Applied Biochemistry and Biotechnology*, 76(2), 143-157. 10.1385/abab:76:2:143
- Towler, G., & Sinnott, R.K. (2013). *Chemical engineering design - Principles, practice, and economics of plant and process design* (2nd ed.). Elsevier.
- Treybal, R. (1951) *Liquid Extraction*. McGraw-Hill.
- Uline. (n.d.-a). 48 x 40 x 48" Double Wall Gaylord Box with Lid. www.uline.com/Product/Detail/S-22574/Bulk-Cargo/48-x-40-x-48-Double-Wall-Gaylord-Box-with-Lid
- Uline. (n.d.-b). IBC tank with steel pallet - 330 gallon. www.uline.com/Product/Detail/H-4420/IBC-Tanks/IBC-Tank-with-Steel-Pallet-330-Gallon
- Uline. (n.d.-c). Plastic Drum - 30 Gallon, Closed Top, Natural. www.uline.com/Product/Detail/S-17008/Drums/Plastic-Drum-30-Gallon-Closed-Top-Natural
- USA Lab (n.d.-a). 120lb n-Butane tank. www.usalab.com/120lb-n-butane-tank/
- USA Lab (n.d.-b). USA Lab 100L/200LB Mixing Solvent Tank w/ RH-30L and ½ HP USA Made Motor. www.usalab.com/usa-lab-100l-200lb-mixing-solvent-tank-w-rh-30l-and-1-2-hp-usa-made-motor/
- Van der Marel, G.M., De Vries, A.W., van Logtestijn, J.G., & Mossel, D.A.A. (1989). Effect of lactic acid treatment during processing on the sensory quality and lactic acid content of fresh broiler chickens. *Int. J. Food Sci. Technol.* 24, 11. doi.org/10.1111/j.1365-2621.1989.tb00614.x

- Vecchiarello, N. (2023). *Solid-Fluid Separations in Bioprocessing*.
- Wang, Y., Tuccillo, F., Lampi, A. M., Knaapila, A., Pulkkinen, M., Kariluoto, S., Coda, R., Edelmann, M., Jouppila, K., Sandell, M., Piironen, V., & Katina, K. (2022). Flavor challenges in extruded plant-based meat alternatives: A review. *Comprehensive Reviews in Food Science and Food Safety*, 21, 2898–2929. doi.org/10.1111/1541-4337.12964
- Webstaurant Store. (n.d.-a). Golden Dipt 50 lb. Pre-Dip Batter Mix.
www.webstaurantstore.com/golden-dipt-50-lb-pre-dip-batter-mix/104GD700149.html
- Webstaurant Store (n.d.-b). Stratas BBS Flex All-Purpose Shortening 50 lb.
www.webstaurantstore.com/stratas-bbs-flex-all-purpose-shortening-50-lb/101SHT101341.html
- Webstaurant Store (n.d.-c). Texas Fried Chicken Breeding - 40 lb.
www.webstaurantstore.com/40-lb-texas-fried-chicken-breeding/104TEXAS40.html
- Webstaurant Store (n.d.-d). Hobart Legacy HSL300-1 228 qt. Two-Speed Spiral Dough Mixer.
www.webstaurantstore.com/hobart-legacy-hsl300-1-300-lb-spiral-dough-mixer-208v-3-phase/425HSL3001.html
- Wenzhou Xusheng Machinery and Trading Co (n.d.) SUS316 Food Grade Clamp Condenser Cooling Pipe Shell Tube Heat Exchanger.
xushengvalves.en.made-in-china.com/product/AnQpCXETVqhW/China-SUS316-Food-Grade-Clamp-Condenser-Cooling-Pipe-Shell-Tube-Heat-Exchanger.html
- Wenzhou Yinou Machinery Co (n.d.) Joston Stainless Steel 1000L 20000L Continuous Stirred Tank Reactor Industrial Batch Reactor.
yinuomachine.en.made-in-china.com/product/axYUcfrzophP/China-Joston-Stainless-Steel-1000L-20000L-Continuous-Stirred-Tank-Reactor-Industrial-Batch-Reactor.html
- Weisshaar, R. (2014, April 22). Quality control of used deep-frying oils. *European Journal of Lipid Science and Technology*, 116(6), 716-722.
doi-org.proxy1.library.virginia.edu/10.1002/ejlt.201300269
- Win, S. S., Impoolsup, A., & Noomhorm, A. (1996). Growth kinetics of *Saccharomyces cerevisiae* in batch and fedbatch cultivation using sugarcane molasses and glucose syrup from cassava starch. *Journal of Industrial Microbiology and Biotechnology*, 16(2), 117–123. doi.org/10.1007/BF01570071
- Zhang, D. Doehlert, D. Moore, W. (1997). Factors Affecting Viscosity of Slurries of Oat Groat Flours. *Cereal Chemistry*, 74(6). 722-726.
<https://onlinelibrary.wiley.com/doi/abs/10.1094/CCHEM.1997.74.6.722>

Zheng, Li., Regenstein, J., Teng, F., & Li, Y. (2020, Nov. 19). Tofu Products: a review of their raw materials, processing conditions, and packaging. *Comprehensive Review in Food Science and Food Safety*, 19(6), 3683-3714. doi.org/10.1111/1541-4337.12640

SECTION 10: APPENDIX

Appendix 3.1.01 Sedimentation Tank Calculations

$$V_g = \frac{4r_p^2(\rho_p - \rho_f)g}{18\mu} \text{ (Science Facts, n.d.)}$$

$$r_p = 0.0015 \text{ m (Darvishi, 2012)}$$

Particle Density

$$\rho_p = 1224 \text{ g/L}$$

The fluid contains 98% water and 2% sodium carbonate, so fluid properties assumed to be that of water

Fluid Density

$$\rho_f = 1000 \text{ g/L}$$

Gravitational Constant

$$g = 9.8 \text{ m/s}^2$$

Fluid Viscosity

$$\mu = 0.001 \text{ Pa}\cdot\text{s}$$

$$V_g = \frac{4(0.0015)^2(1224-1000)9.8}{18 \cdot 0.001} = 1.10 \text{ m/s}$$

L = 2 m, H = 1.5 m, W = 2.5 m (Tank Dimensions)

$$Q = 0.000305 \text{ m}^3/\text{s}$$

$$V = L \cdot W \cdot H = 7.5 \text{ m}^3$$

$$A = W \cdot L = 5 \text{ m}^2$$

$$u = Q / (H \cdot W) = 0.000305 / (1.5 \cdot 2.5) = 0.000081 \text{ m/s}$$

$$\Theta = V / Q = 7.5 / 0.000305 = 24590 \text{ s}$$

$$h = V_g \cdot \Theta = 1.10 \cdot 24590 = 27049 \text{ m}$$

$$v_c = Q/A = 0.000305/5 = 0.000061 \text{ m/s}$$

$V_{eg} > v_c \rightarrow 100\% \text{ efficiency}$

Appendix 3.1.02 Rotational Speed Calculations

$$n = S * V^{0.1} * \left(9.81 * \frac{\rho_s - \rho_l}{\rho_l}\right)^{0.45} * X^{0.13} * dp^{0.2} * D^{-0.85} \text{ (Ankur, 2016)}$$

Zwietering Constant S S=3.7 (Ankur, 2016)

Particle size $dp = 3000 \mu\text{m}$

Viscosity $\nu = 0.001 \text{ kg/ms}$

Ratio of solids to liquid $X = 1$

Impeller Diameter $D = 0.3 \text{ m}$

Solid density $\rho_s = 1224 \text{ kg/m}^3$

Liquid density $\rho_l = 1000 \text{ kg/m}^3$ (assumed that of water)

$n = 73 \text{ rpm}$

Appendix 3.2.01 Power Requirements Calculation for Sesame Cake Digestor

$$\frac{D^2 n \rho_l}{\mu} = k \left(\frac{dn^2}{g} \right)^5 \left(\frac{\rho_l - \rho_s}{\rho_l} \right)^{-6} \left(\frac{d}{D} \right)^{-8}$$

D = 2.945 m

Rhol = 993 kg/m³ (at 37°C)(EngineeringToolbox, 2004c)

Mu = 19 Pas (Zhang et al, 1997)

K = 254

g = 9.8 m/s²

d = 70*10⁻⁶ m

Rhos = 640 kg/m³ (EngineeringToolbox, 2010)

Solving for n = .02598 rad/s

Minimal mixing achieved

Raise to .74 rad/s

Find Reynolds Number

$\frac{nD_i^2 \rho}{\mu} = 83.7 \sim$ the high viscosity results in turbulent mixing unachievable

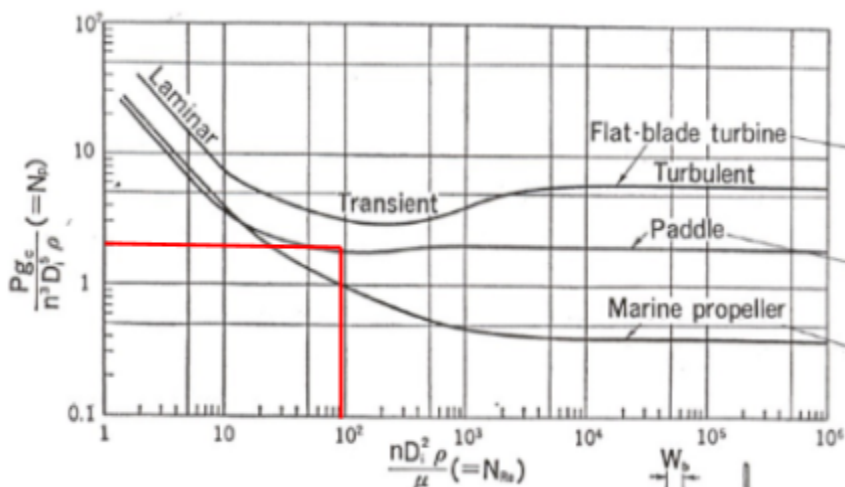

$$N_p \rho n^3 d^5 = P$$

$$P = 5470 \text{ watts}$$

Appendix 3.2.02 Sample Calculation for centrifuge for fermented seed cake

$$Q = \Sigma_{\tau} \cdot V_g$$

$$Q = 0.840 \frac{m^3}{hr} \times \frac{1 hr}{3600 s} = 0.00022 \frac{m^3}{s}$$

$$V_g = \frac{4r_p^2(\rho_p - \rho_f)g}{18\mu} = \frac{4 \cdot (10^{-6} m)^2 (1370 \frac{kg}{m^3} - 1000 \frac{kg}{m^3}) 9.8 \frac{m}{s^2}}{18 \cdot 9 Pa \cdot s} = 8.95 \times 10^{-11} \frac{m}{s}$$

$$\Sigma_{\tau} = \frac{Q}{V_g} = \frac{0.00022 \frac{m^3}{s}}{8.95 \times 10^{-11} \frac{m}{s}} = 2.6 * 10^6 m^2$$

$$\Sigma_{\tau} = \frac{2\pi(n-1)}{3g} \omega^2 \cot\theta (R_0^3 - R_i^3)$$

$$\omega = \left(\Sigma_{\tau} \times \frac{3g}{2\pi(n-1)\cot(\theta)(R_0^3 - R_i^3)} \right)^{1/2} = \left(2.6 * 10^6 m^2 \times \frac{3 \cdot 9.8 \frac{m}{s^2}}{2\pi(100-1)\cot(50)(0.6^3 - 0.25^3)} \right)^{1/2} = 718 \frac{rad}{s}$$

$$718 \frac{rad}{s} \times \frac{60s}{1 min} \times \frac{1 rotation}{2\pi rad} = 6858 RPM$$

Appendix 3.2.03 Van 't Hoff Osmotic Pressure Calculation

$$\pi = i * R * T * \bar{m}$$

i=1 nonionic

R=.08314 liter*bar/mol/K

T=310K

$$\bar{m} = \frac{100g}{1L} * \frac{1mol}{27000g} = .002$$

$$\pi = 1 *.08314 * 310 *.002 = .0515 \text{ bar}$$

Appendix 3.2.04 Example Flooding Velocity Calculation

2:1 Aqueous Organic Ratio → $U_c/U_d=.5$

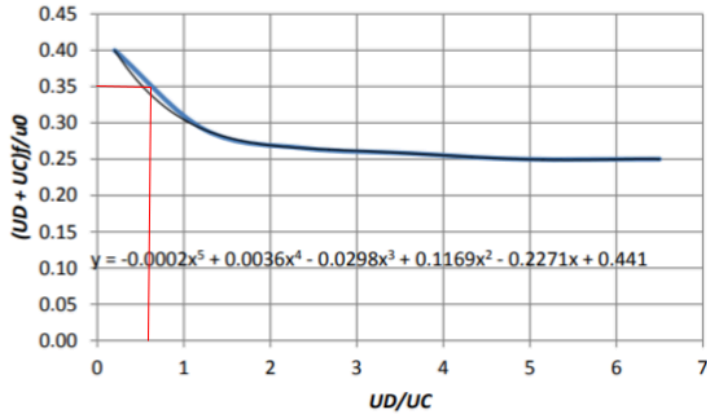

$$(U_d + U_c) f / U_o = .35$$

$$U_o = \frac{.01 \cdot \sigma \cdot \Delta \rho}{\rho_c \mu_c}$$

Octanol TOA-Water interactions

$$\sigma = .032 \text{ J/m}^2$$

$$\Delta \rho = 1000 - 830 = 170 \frac{\text{kg}}{\text{m}^3}$$

$$\rho_c = 1000 \frac{\text{kg}}{\text{m}^3}$$

$$\mu_c = .001 \text{ Pa} \cdot \text{s}$$

$$U_o = .0544 \frac{\text{m}}{\text{s}}$$

$$f = .5$$

$$(U_d + U_c) = .00952 \text{ m/s}$$

$$A \cdot (U_d + U_c) = V$$

$$A = \frac{.0002438 \frac{\text{m}^3}{\text{s}}}{.00952 \frac{\text{m}}{\text{s}}} = .0256 \text{ m}^2$$

Appendix 3.4.01. Sample calculation using Arrhenius rule for liquid mixture viscosity of seed fermenter feed

$$\ln\eta_{mix} = \sum_{i=1}^N x_i \ln\eta_i$$

Seed fermenter feed: 100L, 400 g yeast, 800 g molasses, 100 kg water (100L)

$$x_{molasses} = \frac{800}{(400+800+100000)} = 0.0079 \frac{g \text{ molasses}}{g}$$

$$x_{water} = \frac{100000}{(400+800+100000)} = 0.988 \frac{g \text{ water}}{g}$$

$$\eta_{molasses} = 4.2 \text{ Pa*s (Misljenovic et al., 2013)}$$

$$\eta_{water} = 0.000797 \text{ Pa*s (The Engineering Toolbox, 2004)}$$

$$\ln\eta_{mix} = (0.0079) * \ln(4.2) + (0.988) * \ln(0.000797) = - 7.038$$

$$\eta_{mix} = \underline{0.000878 \text{ Pa*s}}$$

Appendix 3.4.02. Sample calculation of mixture density for feed into seed fermenter

Seed fermenter feed: 100L, 400 g yeast, 800 g molasses, 100 kg water (100L)

Total mass = 400 + 800 + 100000 = 101200 g

Total volume = 100 L

$\rho = 101200 \text{ g}/100 \text{ L} = \underline{1012 \text{ kg/m}^3}$

Appendix 3.4.03. Sample calculation of target k_La for seed fermenter

Target cell output, $X = 41.6$ g/L

[variable name] $Q_{O_2} = 0.0136$ gO₂/gX-h

[variable name] $C^* = 0.00104$ g/L

[variable name] $C^{crit} = 0.006935$ g/L

$OUR_{max} = Q_{O_2} * X = 41.6 * 0.0136 = 0.56576$ g/L-h

$k_La = OUR_{max} / (C^* - C^{crit}) = (0.56576 \text{ g/L-h}) / [(0.00104 \text{ g/L}) - (0.006935 \text{ g/L})] = \underline{96.0 \text{ h}^{-1}}$

Appendix 3.4.04. Sample calculation of design $k_L a$ and power requirements for seed fermenter

$$\rho = 1012 \text{ kg/m}^3$$

$$N = 125 \text{ RPM}$$

$$Q_g = 0.2 \text{ vvm} = 0.01 \text{ m}^3/\text{s}$$

$$D_t = 0.860 \text{ m}$$

$$D_i = 0.287 \text{ m}$$

$$n_i = 1$$

$$f_c = 1$$

$$\text{Tip speed} = \pi N D_i = \pi (2.08 \text{ s}^{-1}) (0.287 \text{ m}) = 1.877 \text{ m/s}$$

$$Re = \frac{N D_i^2 \rho}{\mu} = \frac{(2.08 \text{ s}^{-1}) (0.287 \text{ m})^2 (1012 \text{ kg/m}^3)}{(0.000878 \text{ kg/m-s})} = 197449 \text{ (turbulent)}$$

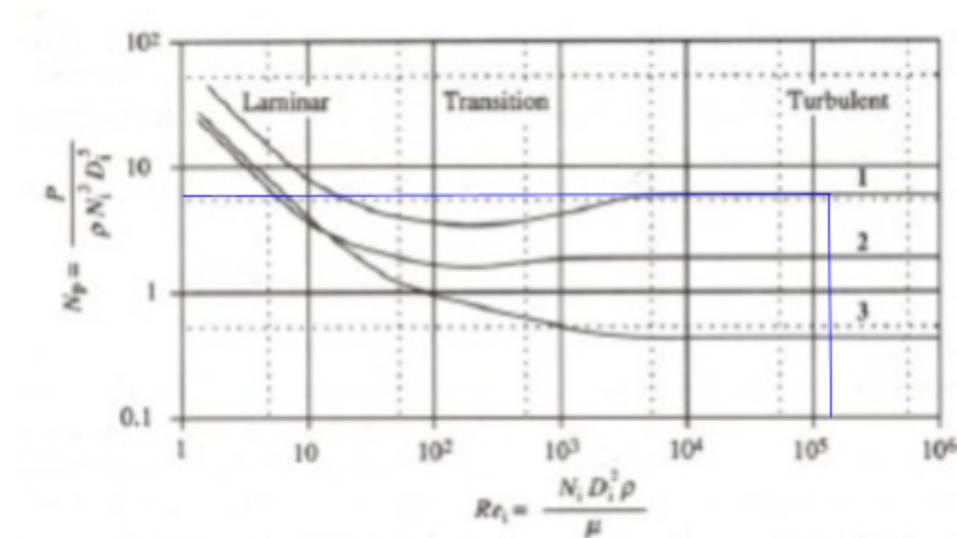

$$N_p = 6.2$$

$$P = N_p * \rho * N^3 * D_i^5 = (6.2) (1012 \text{ kg/m}^3) (2.08 \text{ s}^{-1})^3 (0.287 \text{ m})^5 = 110 \text{ W}$$

$$N_a = \frac{Q_g}{N/D_i^3} = \frac{0.01 \text{ m}^3/\text{s}}{(2.08 \text{ s}^{-1}) / (0.287 \text{ m})^3} = 0.2036$$

$$P_g/P \sim -0.04167(N_a * 100) + 1 = -0.04167(20.36) + 1 = 0.1516$$

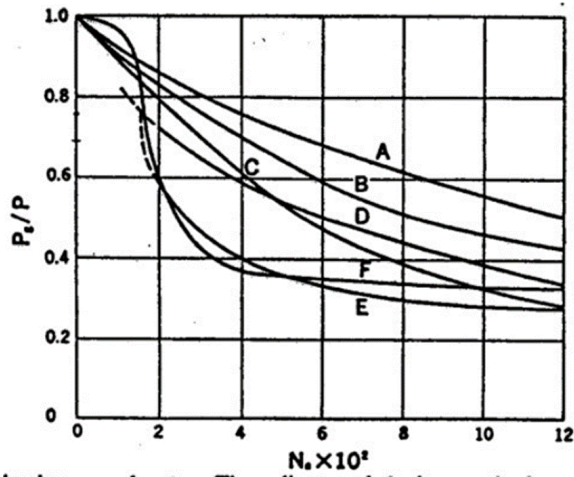

$$P_{tot} = P * f_c * n_i * P_g/P = (110W)(1)(1)(0.1516) = \underline{16.5 W}$$

$$P_g/V = P_{tot}/V = 16.5W/0.5m^3 = \underline{33.0 W/m^3}$$

$$\text{Design } k_L a = \frac{0.0333}{D_t^4 * (P_g/V)^{0.541} * Q_g^{0.541/\sqrt{D_t}}} = \frac{0.033}{(0.860m)^4 (33W/m^3)^{0.541} (0.01m^3/s)^{0.541/\sqrt{(0.860m)}}} = 0.027s^{-1} =$$

$$\underline{98.9h^{-1}}$$

All calculations were performed in Excel. This process was used for design of both the seed and production fermenters in the yeast extract fermentation block.

Appendix 3.4.05 Mixing Tank Energy Calculation

Seed feed mixing tank:

Volume: $382.18L = 0.38218 \text{ m}^3$

Tank dimensions (based on a 0.8 height to diameter ratio):

$$H = 0.678 \text{ m}, D = 0.847 \text{ m}$$

Impeller diameter (assume $\frac{1}{3}$ of the tank diameter)

$$D_i = 0.282 \text{ m}$$

Physical property calculations:

$$\text{Density: } \rho = \frac{121.07 \text{ kg} * 1400 + 300.92 \text{ kg} * 1000}{421.99 \text{ kg}} = 1115 \frac{\text{kg}}{\text{m}^3}$$

$$\text{Viscosity: } \mu = \frac{121.07 \text{ kg} * 9.5 \text{ Pa-s} + 300.92 \text{ kg} * 0.001 \text{ Pa-s}}{421.99 \text{ kg}} = 2.73 \text{ Pa-s}$$

$$\text{Viscosity molasses} = 9.5 \text{ Pa-s (Misljenovic et al., 2013)}$$

Power requirement calculator (assuming 125 RPM):

$$Re = \frac{D^2 N \rho}{\mu} = \frac{(0.28\text{m})^2 * 2.083 \frac{1}{s} * 1115 \frac{\text{kg}}{\text{m}^3}}{2.73 \text{ Pa-s}} = 91.04$$

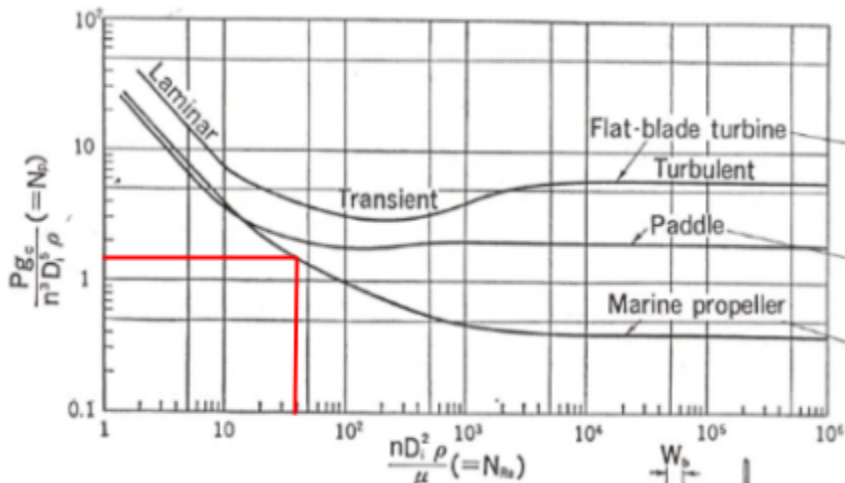

$$N_p = 1.5$$

$$P = N_p \rho N^3 D^5 = 1.5 * 1115 \frac{\text{kg}}{\text{m}^3} * (2.083 \frac{1}{s})^3 (0.282\text{m})^5 = 27\text{W}$$

Appendix 3.5.01. Frying Oil Uptake Calculation

Frying time, $t = 180\text{s}$

Flow rate into fryer = 376.265 lbs/hr

Moisture loss: $x=0.083t = 0.083(180\text{s}) = 14.94\%$

Oil uptake: $y=0.041t = 0.041(180\text{s}) = 7.38\%$

Assume moisture loss and oil uptake are approximately equal, use the average of these two.

$$\frac{7.38+14.94}{2} = 11.16\%$$

Oil uptake and moisture loss = $0.1116*376.265\text{ lbs/hr} = 41.991\text{ lbs/hr}$

Appendix 5.1.01 Pricing of Aerobic Yeast Fermenters

The prices of specific sizes of aerobic fermenters were not able to be found. To give an estimation of the fermenter price, a price correlation was able to be created based on a study of yeast extract production and information from a retailer which gave a range of prices. The study by Misailidis & Petrides (2020) determined prices of fermentation vessels based on size through SuperPro designer. Using these prices, a correlation between fermenter volume and size was created, shown in the figure below.

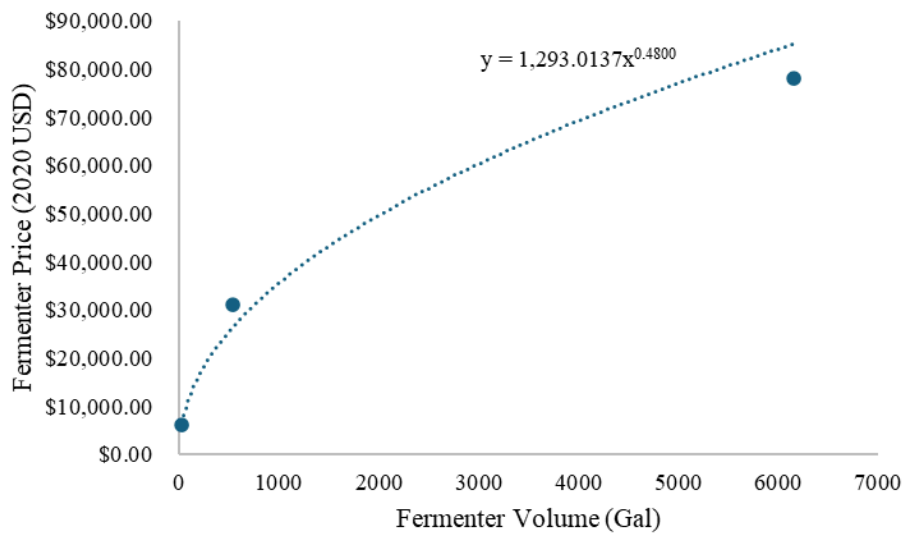

The fermenter price (in 2020 USD) was determined from the correlation, and then adjusted to 2024 USD using the CEPCI. It was assumed that the required equipment (i.e. compressors, agitators) were accounted for in this price.